

Dell PowerEdge R570

Installation and Service Manual

Notes, cautions, and warnings

 **NOTE:** A NOTE indicates important information that helps you make better use of your product.

 **CAUTION:** A CAUTION indicates either potential damage to hardware or loss of data and tells you how to avoid the problem.

 **WARNING:** A WARNING indicates a potential for property damage, personal injury, or death.

Chapter 1: About this document	8
Chapter 2: PowerEdge R570 system configurations and features	9
System configurations - front view for PowerEdge R570 system.....	10
System configurations - rear view for PowerEdge R570 system.....	22
System configurations - inside view for PowerEdge R570 system.....	27
Locating the Express Service Code and Service Tag.....	28
System information label.....	29
Rail sizing and rack compatibility matrix.....	33
Chapter 3: Technical specifications	34
Chassis dimensions	35
System weight.....	36
Processor specifications.....	36
PSU specifications.....	36
Cooling fan specifications.....	38
Supported operating systems.....	39
System battery specifications.....	39
Expansion card riser specifications.....	39
Memory specifications.....	40
Storage controller specifications.....	40
Drives.....	41
GPU Specifications.....	41
Ports and connectors specifications.....	41
NIC port specifications.....	41
USB ports specifications.....	42
Serial connector specifications.....	42
Video ports specifications.....	42
Environmental specifications.....	43
Particulate and gaseous contamination specifications.....	44
Thermal restriction matrix.....	45
Thermal air restrictions.....	49
Chapter 4: Initial system setup and configuration	51
Setting up the system.....	51
iDRAC configuration.....	51
Options to set up iDRAC IP address.....	51
Options to log in to iDRAC.....	52
Resources to install operating system.....	52
Options to download drivers and firmware	53
Options to download and install OS drivers	53
Downloading drivers and firmware.....	53
Chapter 5: Pre-operating system management applications	55

System Setup.....	55
System BIOS.....	56
iDRAC Settings.....	56
Device Settings.....	56
Boot Manager.....	56
PXE boot.....	56
Chapter 6: Minimum to POST and system management configuration validation.....	57
Minimum configuration to POST	57
Chapter 7: Configuration validation.....	58
Chapter 8: Disassembly and reassembly.....	59
Safety instructions.....	59
Before working inside your system	60
After working inside your system.....	60
Recommended tools.....	60
Optional front bezel.....	61
Removing the front bezel.....	61
Installing the front bezel.....	62
System cover.....	62
Removing the system cover.....	62
Installing the system cover.....	63
Air shroud.....	64
Removing the air shroud.....	64
Installing the air shroud.....	65
Cooling fans.....	67
Removing a cooling fan.....	67
Installing a cooling fan.....	67
Removing the cooling fan cage assembly	68
Installing the cooling fan cage assembly.....	69
Removing the rear E3.S module cooling fan.....	70
Installing the rear E3.S module cooling fan.....	71
Drive backplane cover.....	72
Removing the drive backplane cover.....	72
Installing the drive backplane cover.....	73
Drives.....	74
Removing an EDSFF E3.S drive blank.....	74
Installing an EDSFF E3.S drive blank.....	75
Removing an EDSFF E3.S drive carrier.....	76
Removing an EDSFF E3.S drive from the drive carrier.....	77
Installing an EDSFF E3.S drive into the drive carrier.....	78
Installing an EDSFF E3.S drive carrier.....	79
Removing a 2.5-inch drive blank.....	80
Installing a 2.5-inch drive blank.....	81
Removing a 2.5-inch drive carrier.....	81
Removing a 2.5-inch drive from the drive carrier.....	82
Installing a 2.5-inch drive into the drive carrier.....	83
Installing a 2.5-inch drive carrier.....	84

Removing a 3.5-inch drive blank.....	85
Installing a 3.5-inch drive blank.....	86
Removing a 3.5-inch drive carrier.....	86
Removing a 3.5-inch drive from the drive carrier.....	87
Installing a 3.5-inch drive into the drive carrier.....	88
Installing a 3.5-inch drive carrier.....	89
Rear Drives.....	90
Removing the rear 4 x EDSFF E3.S module.....	90
Installing the rear EDSFF E3.S module.....	91
Drive backplane.....	92
Drive backplane.....	92
Removing the 2.5-inch drive backplane module.....	94
Installing the 2.5-inch drive backplane module.....	94
Removing the 3.5-inch drive backplane module.....	95
Installing the 3.5-inch drive backplane module.....	96
Removing the EDSFF E3.S backplane module.....	97
Installing the EDSFF E3.S backplane module.....	98
Side wall brackets.....	99
Removing the side wall bracket.....	99
Installing the side wall bracket.....	100
Cable routings.....	101
System memory.....	125
System memory guidelines.....	125
General memory module installation guidelines.....	127
Removing a memory module.....	128
Installing a memory module.....	129
Processor and heat sink.....	131
Removing the processor and heat sink module.....	131
Removing the processor.....	133
Installing the processor.....	135
Installing the processor and heat sink module.....	138
PERC cards.....	140
Removing the fPERC module.....	140
Installing the fPERC module.....	141
Expansion cards and expansion card risers.....	142
Expansion card installation guidelines.....	143
Removing the front expansion card risers.....	158
Installing the front expansion card risers.....	161
Removing an expansion card from the front expansion card riser.....	163
Installing an expansion card into the front expansion card riser.....	165
Removing the rear expansion card risers.....	167
Installing the rear expansion card risers.....	170
Removing an expansion card from the expansion card riser.....	173
Installing an expansion card into the expansion card riser.....	178
Removing the rear expansion card riser blank.....	183
Installing the rear expansion card riser blank.....	185
M.2 SSD module.....	187
Removing the M.2 NVMe SSD module.....	187
Installing the M.2 NVMe SSD module.....	189
Removing the M.2 NVMe SSD module from the M.2 Interposer board.....	191

Installing the M.2 NVMe SSD module in the M.2 Interposer board.....	192
Optional M.2 Interposer board.....	197
Removing the M.2 Interposer board.....	197
Installing the M.2 Interposer board.....	198
Optional BOSS-N1 DC-MHS module.....	203
Removing the BOSS-N1 DC-MHS card carrier blank.....	203
Installing the BOSS-N1 DC-MHS card carrier blank.....	204
Removing the front BOSS-N1 DC-MHS module.....	204
Installing the front BOSS-N1 DC-MHS module.....	206
Removing the rear BOSS-N1 DC-MHS module.....	208
Installing the rear BOSS-N1 DC-MHS module.....	210
Optional OCP NIC card.....	211
Removing the front OCP NIC card.....	211
Installing the front OCP NIC card.....	213
Removing the rear OCP NIC card.....	215
Installing the rear OCP NIC card.....	216
Datacenter-Secure Control Module (DC-SCM).....	218
Removing the DC-SCM board.....	218
Installing the DC-SCM board.....	219
Restoring the system using Easy Restore.....	220
Manually update the Service Tag.....	221
Attic board.....	221
Removing the Attic board.....	222
Installing the Attic board.....	222
Internal USB.....	223
Removing the internal USB	223
Installing the Internal USB	224
System battery.....	225
Replacing the system battery.....	225
Intrusion switch.....	227
Removing the intrusion switch module.....	227
Installing the intrusion switch module.....	228
Power supply unit.....	229
Removing a power supply unit.....	229
Installing a power supply unit.....	229
Removing a power supply unit blank.....	230
Installing a power supply unit blank.....	231
Installing a power supply unit filler.....	231
Installing a power supply unit filler.....	232
Trusted Platform Module.....	233
Initializing TPM 2.0 for users.....	234
HPM board.....	234
Removing the HPM board.....	234
Installing the HPM board.....	235
Control panel.....	236
Removing the right control panel (RCP) - Primary.....	236
Installing the Right Control Panel (RCP) - Primary.....	237
Removing the KVM/Quick Sync Left Control Panel (LCP) - Secondary.....	238
Installing the KVM/Quick Sync Left Control Panel (LCP) - Secondary.....	239

Chapter 9: Upgrade Kits.....	242
Processor upgrade kit components.....	242
Processor upgrade guidelines.....	243
GPU upgrade kit.....	244
M.2 Interposer kit.....	245
BOSS-N1 DCHMS module kit.....	246
PERC module kit.....	246
 Chapter 10: System diagnostics and indicator codes.....	 250
Power button LED.....	250
System health and system ID indicator codes.....	251
iDRAC Direct LED indicator codes.....	251
iDRAC Quick Sync 2 indicator codes.....	252
NIC indicator codes.....	252
Power supply unit indicator codes.....	253
Drive indicator codes.....	254
Using system diagnostics.....	256
Dell Embedded System Diagnostics.....	256
 Chapter 11: Jumpers and connectors.....	 257
HPM board jumpers and connectors	257
HPM board jumper settings.....	259
Disabling a forgotten password.....	259
 Chapter 12: Getting Help.....	 261
Recycling or End-of-Life service information.....	261
Contact Dell Technologies.....	261
Accessing system information by using MyDell.....	261
QR code for PowerEdge R570 system resources.....	262
Receiving automated support with Secure Connect Gateway (SCG).....	262
 Chapter 13: Documentation resources.....	 263

About this document

This document provides an overview about the system, information about installing and replacing components, diagnostic tools, and guidelines to be followed while installing certain components.

PowerEdge R570 system configurations and features

The PowerEdge R570 system is a 2U server that supports:

- One Intel® Xeon® 6 E-core processor with up to 144 cores
- One Intel® Xeon® 6 P-core processor with up to 86 cores with R1S option
- 16 DIMM slots
- Two redundant AC or DC* power supply units
- Up to 12 x 3.5-inch SATA (HDD) RAID drives+ 4 x EDSFF E3.S Gen5 NVMe drives
- Up to 8 x 2.5-inch NVMe (SSD) RAID drives
- Up to 8 x 2.5-inch NVMe (SSD) drives
- Up to 8 x 2.5-inch SATA (HDD/SSD) drives
- Up to 8 x 2.5-inch SATA/Universal (HDD/SSD) drives
- Up to 16 x 2.5-inch SATA (HDD/SSD) RAID drives
- Up to 24 x 2.5-inch SATA (HDD/SSD) drives
- Up to 8 x EDSFF E3.S (hot-aisle) Gen5 NVMe drives
- Up to 8 x EDSFF E3.S (cold-aisle) Gen5 NVMe drives
- Up to 16 x EDSFF E3.S (cold-aisle) Gen5 NVMe drives
- Up to 16 x EDSFF E3.S (hot-aisle) Gen5 NVMe drives
- Up to 32 x EDSFF E3.S (hot-aisle) Gen5 NVMe drives

i **NOTE:** For more information about how to hot swap NVMe PCIe SSD device, see the *Dell Express Flash NVMe PCIe SSD User's Guide* at [Dell Support](#) page > **Browse all products > Infrastructure > Data Center Infrastructure > Storage Adapters & Controllers > Dell PowerEdge Express Flash NVMe PCIe SSD > Select This Product > Documentation > Manuals and Documents.**

i **NOTE:** All instances of SATA drives are referred to as drives in this document, unless specified otherwise.

i **NOTE:** The system board is known as the Host Processor Module (HPM) board in this document.

i **NOTE:** This document provides a comprehensive list of product features. However, features marked with an asterisk (*) may not be available at launch but introduced in future updates. Please note that this document does not confirm the availability or release timeline of any feature. For the most accurate and up-to-date information on feature availability, please refer to the product configurator page on [dell.com](#).

⚠ CAUTION: Do not install GPUs, network cards, or other PCIe devices on your system that are not validated and tested by Dell. Damage caused by unauthorized and invalidated hardware installation will null and void the system warranty.

Topics:

- [System configurations - front view for PowerEdge R570 system](#)
- [System configurations - rear view for PowerEdge R570 system](#)
- [System configurations - inside view for PowerEdge R570 system](#)
- [Locating the Express Service Code and Service Tag](#)
- [System information label](#)
- [Rail sizing and rack compatibility matrix](#)

System configurations - front view for PowerEdge R570 system

Front views of R570

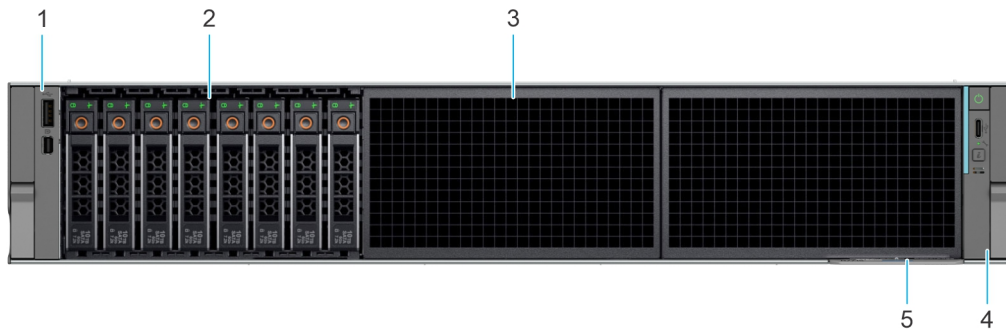

Figure 1. Front view of 8 x 2.5-inch drive system

Table 1. The table shows the list of components in front view of the system.

Item	Ports, panels, and slots	Icon	Description
1	Left control panel (LCP) - Secondary	N/A	<p>Contains the USB 2.0 Type-A port (optional LCP - Secondary KVM) and the Mini DisplayPort (optional LCP - Secondary KVM).</p> <ul style="list-style-type: none"> • USB 2.0 Type-A port (optional LCP - Secondary KVM): This port is USB 2.0-compliant with optional LCP - Secondary KVM functions. • Mini DisplayPort: Enables you to connect a display device to the system. <p>NOTE: Use a certified Mini DisplayPort to DisplayPort cable complying with VESA DisplayPort standards for video output with a monitor.</p> <p>NOTE: Mini DisplayPort to VGA or Mini DisplayPort to HDMI adapters are not recommended.</p>
2	2.5-inch drives	N/A	Enables you to install drives that are supported on your system.
3	Drive blank	Blank	Blank filler for the storage drive slot

Table 1. The table shows the list of components in front view of the system. (continued)

Item	Ports, panels, and slots	Icon	Description
4	Right control panel (RCP) - Primary	N/A	Contains the system health LED, system ID, power button, Type-C USB port, and the host status LED.
5	Express Service Tag	N/A	The Express service tag is a slide-out label panel that contains system information such as Service Tag, NIC, MAC address, and so on. If you have opted for the secure default access to iDRAC, the Express service tag also contains the iDRAC secure default password.

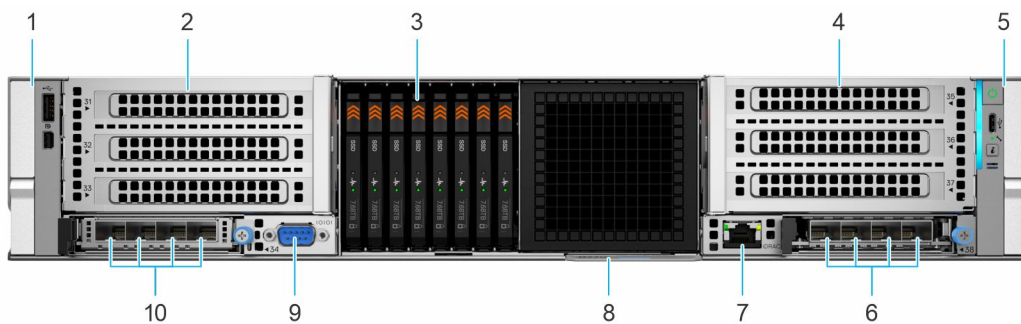

Figure 2. Front view of 8 x EDSFF E3.S NVMe (cold-aisle) drive system

Table 2. The table shows the list of components in front view of the system.

Item	Ports, panels, and slots	Icon	Description
1	Left control panel (LCP) - Secondary	N/A	<p>Contains the USB 2.0 Type-A port (optional LCP - Secondary KVM) and the Mini DisplayPort (optional LCP - Secondary KVM).</p> <ul style="list-style-type: none"> • USB 2.0 Type-A port (optional LCP - Secondary KVM): This port is USB 2.0-compliant with optional LCP - Secondary KVM functions. • Mini DisplayPort: Enables you to connect a display device to the system. <p>NOTE: Use a certified Mini DisplayPort to DisplayPort cable complying with VESA DisplayPort standards for video output with a monitor.</p> <p>NOTE: Mini DisplayPort to VGA or Mini DisplayPort to</p>

Table 2. The table shows the list of components in front view of the system. (continued)

Item	Ports, panels, and slots	Icon	Description
			HDMI adapters are not recommended.
2	PCIe front expansion card riser 1	Blank	The expansion card riser enables you to connect PCI Express expansion cards.
3	EDSFF E3.S drives	N/A	Enables you to install drives that are supported on your system.
4	PCIe front expansion card riser 3	Blank	The expansion card riser enables you to connect PCI Express expansion cards.
5	Right control panel (RCP) - Primary	N/A	Contains the system health LED, system ID, power button, Type-C USB port, and the host status LED.
6	OCP NIC (Primar/Secondary) i NOTE: Primary OCP is on slot 38 at the bottom.	N/A	Enables you to install Primary/secondary OCP based on riser configurations .
7	Dedicated iDRAC Ethernet port	N/A	Enables you to access iDRAC port.
8	Drive blank	Blank	Blank filler for the storage drive slot
9	Serial COM port		Enables you to connect a serial device to the system.
10	OCP NIC or BOSS-N1 DC-MHS (Slot 34)	N/A	Enables you to install a secondary OCP or BOSS-N1 DC-MHS controller based on riser configuration. i NOTE: Secondary OCP does not support the shared NIC feature.



Figure 3. Front view of 16 x EDSFF E3.S NVMe (cold-aisle) drive system

Table 3. The table shows the list of components in front view of the system.

Item	Ports, panels, and slots	Icon	Description
1	Left control panel (LCP) - Secondary	N/A	Contains the USB 2.0 Type-A port (optional LCP - Secondary KVM) and the Mini

Table 3. The table shows the list of components in front view of the system. (continued)

Item	Ports, panels, and slots	Icon	Description
			DisplayPort (optional LCP - Secondary KVM). <ul style="list-style-type: none"> • USB 2.0 Type-A port (optional LCP - Secondary KVM): This port is USB 2.0-compliant with optional LCP - Secondary KVM functions. • Mini DisplayPort: Enables you to connect a display device to the system. <p>NOTE: Use a certified Mini DisplayPort to DisplayPort cable complying with VESA DisplayPort standards for video output with a monitor.</p> <p>NOTE: Mini DisplayPort to VGA or Mini DisplayPort to HDMI adapters are not recommended.</p>
2	PCIe front expansion card riser 1	Blank	The expansion card riser enables you to connect PCI Express expansion cards.
3	EDSFF E3.S drives	N/A	Enables you to install drives that are supported on your system.
4	PCIe front expansion card riser 3	Blank	The expansion card riser enables you to connect PCI Express expansion cards.
5	Right control panel (RCP) - Primary	N/A	Contains the system health LED, system ID, power button, Type-C USB port, and the host status LED.
6	OCP NIC (Primary/Secondary) NOTE: Primary OCP is on slot 38 at the bottom.	N/A	Enables you to install Primary/secondary OCP based on riser configurations .
7	Dedicated iDRAC Ethernet port	N/A	Enables you to access iDRAC port.
8	EDSFF E3.S drives	N/A	Enables you to install drives that are supported on your system.
9	Serial COM port		Enables you to connect a serial device to the system.
10	OCP NIC or BOSS-N1 DC-MHS (Slot 34)	N/A	Enables you to install a secondary OCP or BOSS-N1 DC-MHS controller based on riser configuration.

Table 3. The table shows the list of components in front view of the system. (continued)

Item	Ports, panels, and slots	Icon	Description
			i NOTE: Secondary OCP does not support the shared NIC feature.

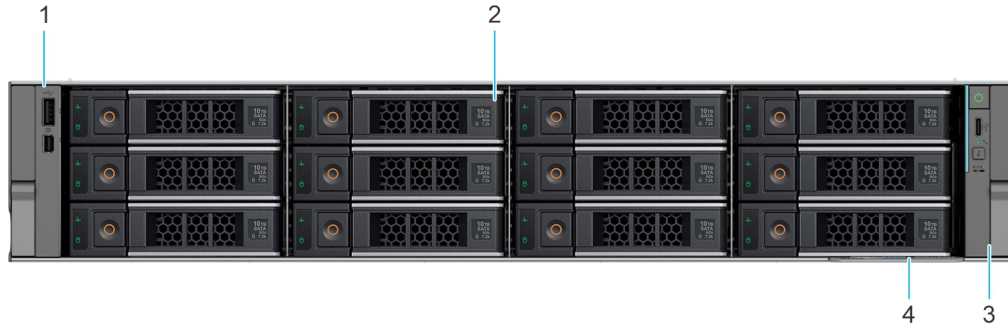

Figure 4. Front view of 12 x 3.5-inch drive system

Table 4. The table shows the list of components in front view of the system.

Item	Ports, panels, and slots	Icon	Description
1	Left control panel (LCP) - Secondary	N/A	<p>Contains the USB 2.0 Type-A port (optional LCP - Secondary KVM) and the Mini DisplayPort (optional LCP - Secondary KVM).</p> <ul style="list-style-type: none"> • USB 2.0 Type-A port (optional LCP - Secondary KVM): This port is USB 2.0-compliant with optional LCP - Secondary KVM functions. • Mini DisplayPort: Enables you to connect a display device to the system. <p>i NOTE: Use a certified Mini DisplayPort to DisplayPort cable complying with VESA DisplayPort standards for video output with a monitor.</p> <p>i NOTE: Mini DisplayPort to VGA or Mini DisplayPort to HDMI adapters are not recommended.</p>
2	3.5-inch drives	N/A	Enables you to install drives that are supported on your system.
3	Right control panel (RCP) - Primary	N/A	Contains the system health LED, system ID, power button, Type-C USB port, and the host status LED.

Table 4. The table shows the list of components in front view of the system. (continued)

Item	Ports, panels, and slots	Icon	Description
4	Express Service Tag	N/A	The Express service tag is a slide-out label panel that contains system information such as Service Tag, NIC, MAC address, and so on. If you have opted for the secure default access to iDRAC, the Express service tag also contains the iDRAC secure default password.

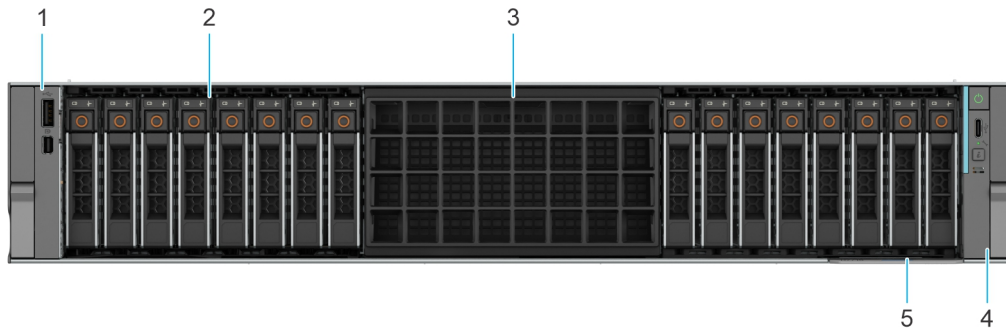

Figure 5. Front view of 16 x 2.5-inch drive system

Table 5. The table shows the list of components in front view of the system.

Item	Ports, panels, and slots	Icon	Description
1	Left control panel (LCP) - Secondary	N/A	<p>Contains the USB 2.0 Type-A port (optional LCP - Secondary KVM) and the Mini DisplayPort (optional LCP - Secondary KVM).</p> <ul style="list-style-type: none"> • USB 2.0 Type-A port (optional LCP - Secondary KVM): This port is USB 2.0-compliant with optional LCP - Secondary KVM functions. • Mini DisplayPort: Enables you to connect a display device to the system. <p>NOTE: Use a certified Mini DisplayPort to DisplayPort cable complying with VESA DisplayPort standards for video output with a monitor.</p> <p>NOTE: Mini DisplayPort to VGA or Mini DisplayPort to HDMI adapters are not recommended.</p>

Table 5. The table shows the list of components in front view of the system. (continued)

Item	Ports, panels, and slots	Icon	Description
2	2.5-inch drives	N/A	Enables you to install drives that are supported on your system.
3	Drive blank	Blank	Blank filler for the storage drive slot
4	Right control panel (RCP) - Primary	N/A	Contains the system health LED, system ID, power button, Type-C USB port, and the host status LED.
5	Express Service Tag	N/A	The Express service tag is a slide-out label panel that contains system information such as Service Tag, NIC, MAC address, and so on. If you have opted for the secure default access to iDRAC, the Express service tag also contains the iDRAC secure default password.

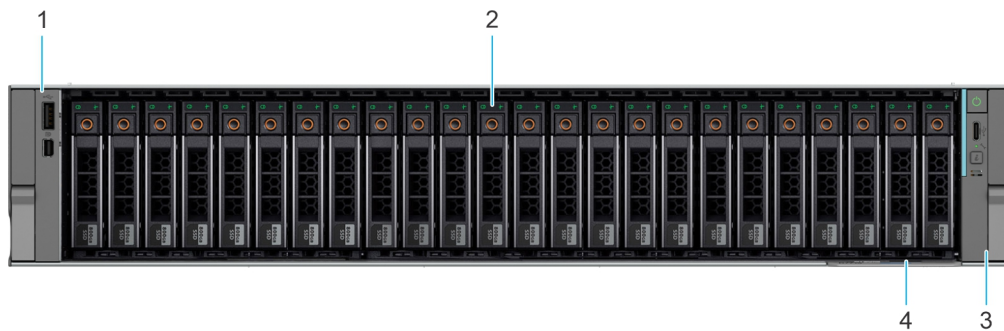

Figure 6. Front view of 24 x 2.5-inch drive system

Table 6. The table shows the list of components in front view of the system.

Item	Ports, panels, and slots	Icon	Description
1	Left control panel (LCP) - Secondary	N/A	<p>Contains the USB 2.0 Type-A port (optional LCP - Secondary KVM) and the Mini DisplayPort (optional LCP - Secondary KVM).</p> <ul style="list-style-type: none"> • USB 2.0 Type-A port (optional LCP - Secondary KVM): This port is USB 2.0-compliant with optional LCP - Secondary KVM functions. • Mini DisplayPort: Enables you to connect a display device to the system. <p>NOTE: Use a certified Mini DisplayPort to DisplayPort cable complying with VESA DisplayPort standards</p>

Table 6. The table shows the list of components in front view of the system. (continued)

Item	Ports, panels, and slots	Icon	Description
			<p>for video output with a monitor.</p> <p>NOTE: Mini DisplayPort to VGA or Mini DisplayPort to HDMI adapters are not recommended.</p>
2	2.5-inch drives	N/A	Enables you to install drives that are supported on your system.
3	Right control panel (RCP) - Primary	N/A	Contains the system health LED, system ID, power button, Type-C USB port, and the host status LED.
4	Express Service Tag	N/A	The Express service tag is a slide-out label panel that contains system information such as Service Tag, NIC, MAC address, and so on. If you have opted for the secure default access to iDRAC, the Express service tag also contains the iDRAC secure default password.

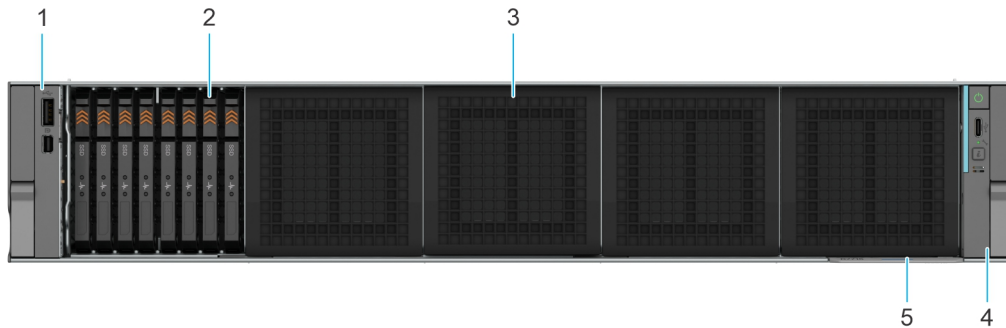

Figure 7. Front view of 8 x EDSFF E3.S NVMe (hot-aisle) drive system

Table 7. The table shows the list of components in front view of the system.

Item	Ports, panels, and slots	Icon	Description
1	Left control panel (LCP) - Secondary	N/A	<p>Contains the USB 2.0 Type-A port (optional LCP - Secondary KVM) and the Mini DisplayPort (optional LCP - Secondary KVM).</p> <ul style="list-style-type: none"> USB 2.0 Type-A port (optional LCP - Secondary KVM): This port is USB 2.0-compliant with optional LCP - Secondary KVM functions.

Table 7. The table shows the list of components in front view of the system. (continued)

Item	Ports, panels, and slots	Icon	Description
			<ul style="list-style-type: none"> Mini DisplayPort: Enables you to connect a display device to the system. <p>NOTE: Use a certified Mini DisplayPort to DisplayPort cable complying with VESA DisplayPort standards for video output with a monitor.</p> <p>NOTE: Mini DisplayPort to VGA or Mini DisplayPort to HDMI adapters are not recommended.</p>
2	EDSFF E3.S drives	N/A	Enables you to install drives that are supported on your system.
3	Drive blank	Blank	Blank filler for the storage drive slot
4	Right control panel (RCP) - Primary	N/A	Contains the system health LED, system ID, power button, Type-C USB port, and the host status LED.
5	Express Service Tag	N/A	The Express service tag is a slide-out label panel that contains system information such as Service Tag, NIC, MAC address, and so on. If you have opted for the secure default access to iDRAC, the Express service tag also contains the iDRAC secure default password.

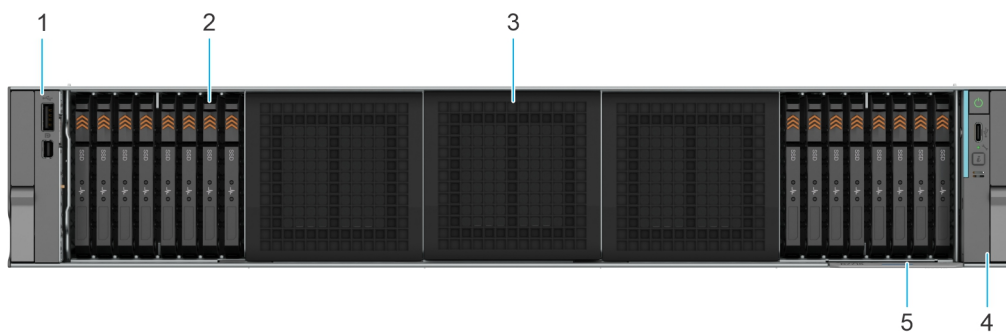

Figure 8. Front view of 16 x EDSFF E3.S NVMe (hot-aisle) drive system

Table 8. The table shows the list of components in front view of the system.

Item	Ports, panels, and slots	Icon	Description
1	Left control panel (LCP) - Secondary	N/A	<p>Contains the USB 2.0 Type-A port (optional LCP - Secondary KVM) and the Mini DisplayPort (optional LCP - Secondary KVM).</p> <ul style="list-style-type: none"> • USB 2.0 Type-A port (optional LCP - Secondary KVM): This port is USB 2.0-compliant with optional LCP - Secondary KVM functions. • Mini DisplayPort: Enables you to connect a display device to the system. <p>NOTE: Use a certified Mini DisplayPort to DisplayPort cable complying with VESA DisplayPort standards for video output with a monitor.</p> <p>NOTE: Mini DisplayPort to VGA or Mini DisplayPort to HDMI adapters are not recommended.</p>
2	EDSFF E3.S drives	N/A	Enables you to install drives that are supported on your system.
3	Drive blank	Blank	Blank filler for the storage drive slot
4	Right control panel (RCP) - Primary	N/A	Contains the system health LED, system ID, power button, Type-C USB port, and the host status LED.
5	Express Service Tag	N/A	The Express service tag is a slide-out label panel that contains system information such as Service Tag, NIC, MAC address, and so on. If you have opted for the secure default access to iDRAC, the Express service tag also contains the iDRAC secure default password.

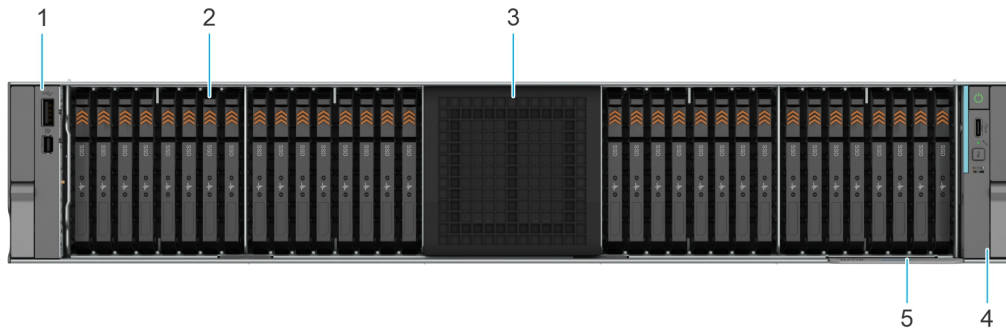

Figure 9. Front view of 32 x EDSFF E3.S NVMe (hot-aisle) drive system

Table 9. The table shows the list of components in front view of the system.

Item	Ports, panels, and slots	Icon	Description
1	Left control panel (LCP) - Secondary	N/A	<p>Contains the USB 2.0 Type-A port (optional LCP - Secondary KVM) and the Mini DisplayPort (optional LCP - Secondary KVM).</p> <ul style="list-style-type: none"> • USB 2.0 Type-A port (optional LCP - Secondary KVM): This port is USB 2.0-compliant with optional LCP - Secondary KVM functions. • Mini DisplayPort: Enables you to connect a display device to the system. <p>NOTE: Use a certified Mini DisplayPort to DisplayPort cable complying with VESA DisplayPort standards for video output with a monitor.</p> <p>NOTE: Mini DisplayPort to VGA or Mini DisplayPort to HDMI adapters are not recommended.</p>
2	EDSFF E3.S drives	N/A	Enables you to install drives that are supported on your system.
3	Drive blank	Blank	Blank filler for the storage drive slot
4	Right control panel (RCP) - Primary	N/A	Contains the system health LED, system ID, power button, Type-C USB port, and the host status LED.
5	Express Service Tag	N/A	The Express service tag is a slide-out label panel that contains system information such as Service Tag, NIC, MAC address, and so on. If

Table 9. The table shows the list of components in front view of the system. (continued)

Item	Ports, panels, and slots	Icon	Description
			you have opted for the secure default access to iDRAC, the Express service tag also contains the iDRAC secure default password.

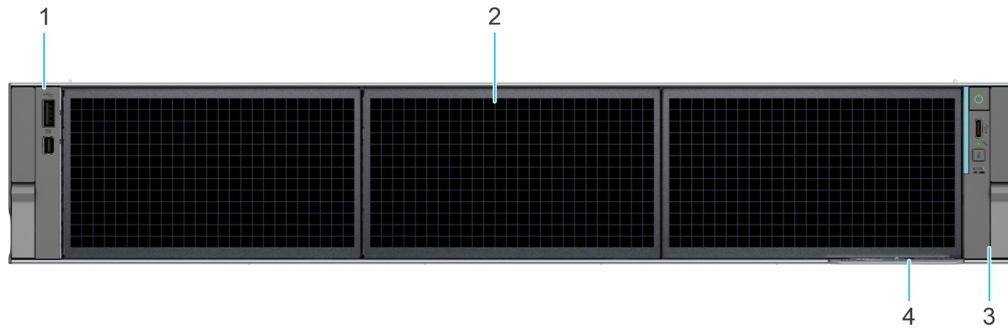

Figure 10. Front view of no backplane configuration system*

Table 10. The table shows the list of components in front view of the system.

Item	Ports, panels, and slots	Icon	Description
1	Left control panel (LCP) - Secondary	N/A	<p>Contains the USB 2.0 Type-A port (optional LCP - Secondary KVM) and the Mini DisplayPort (optional LCP - Secondary KVM).</p> <ul style="list-style-type: none"> • USB 2.0 Type-A port (optional LCP - Secondary KVM): This port is USB 2.0-compliant with optional LCP - Secondary KVM functions. • Mini DisplayPort: Enables you to connect a display device to the system. <p>NOTE: Use a certified Mini DisplayPort to DisplayPort cable complying with VESA DisplayPort standards for video output with a monitor.</p> <p>NOTE: Mini DisplayPort to VGA or Mini DisplayPort to HDMI adapters are not recommended.</p>
2	Drive blank	Blank	Blank filler for the storage drive slot
3	Right control panel (RCP) - Primary	N/A	Contains the system health LED, system ID, power

Table 10. The table shows the list of components in front view of the system. (continued)

Item	Ports, panels, and slots	Icon	Description
			button, Type-C USB port, and the host status LED.
4	Express Service Tag	N/A	The Express service tag is a slide-out label panel that contains system information such as Service Tag, NIC, MAC address, and so on. If you have opted for the secure default access to iDRAC, the Express service tag also contains the iDRAC secure default password.

NOTE: *Feature not available at product launch in September, 2025. Please refer to the product configurator page on Dell.com to confirm feature availability.

System configurations - rear view for PowerEdge R570 system

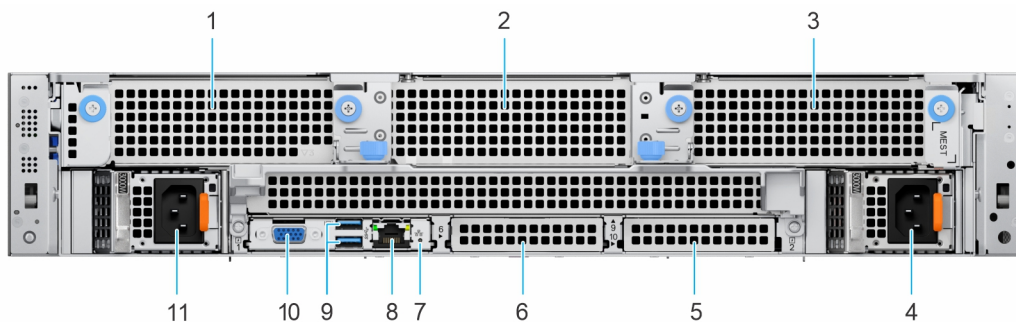

Figure 11. Rear view of the system with front I/O configuration

Table 11. Rear view of the system with front I/O configuration





Item	Ports, panels, or slots	Icon	Description
1	PCIe expansion card riser 1 blank	N/A	In front I/O configuration, the riser blank is installed in the expansion card riser bay.
2	PCIe expansion card riser 3 blank	N/A	
3	PCIe expansion card riser 5 blank	N/A	
4	Power supply unit (PSU2)	 2	PSU2 is the secondary PSU of the system.
5	OCP NIC card filler bracket	N/A	In the front I/O configuration, an OCP filler bracket is installed in the OCP NIC card bay.
6	BOSS filler bracket	N/A	In the front I/O configuration, the BOSS file bracket is installed in BOSS-N1 DC-MHS bay.
7	iDRAC dedicated port		Enables you to remotely access iDRAC. When the front iDRAC port is connected to the network, the rear iDRAC port is automatically disabled.

Table 11. Rear view of the system with front I/O configuration (continued)

Item	Ports, panels, or slots	Icon	Description
8	USB 3.0 port		The USB port is 9-pin and 3.0-compliant. This port enables you to connect USB devices to the system.
9	VGA port		Enables you to connect a display device to the system.
10	Power supply unit (PSU1)		PSU1 is the primary PSU of the system.

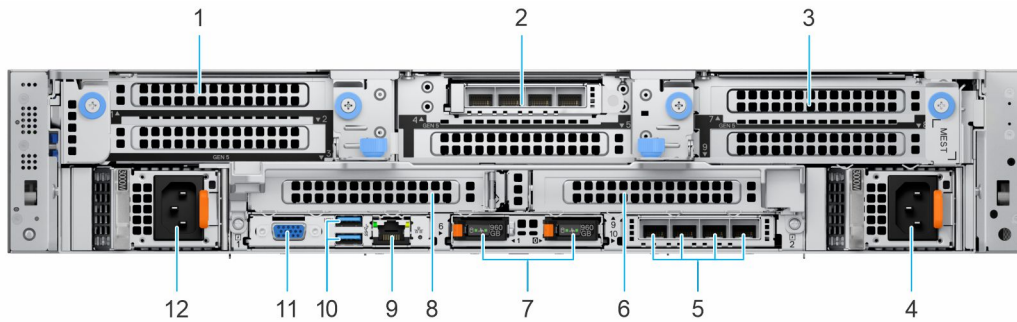

Figure 12. Rear View of the system with rear I/O configuration

Table 12. Rear view of the system with rear I/O configuration





items	Ports, panels, or slots	Icon	Description
1	PCIe expansion card riser 1	N/A	The expansion card riser enables you to connect PCI Express expansion cards.
2	PCIe expansion card riser 3	N/A	The expansion card riser enables you to connect PCI Express expansion cards.
3	PCIe expansion card riser 5	N/A	The expansion card riser enables you to connect PCI Express expansion cards.
4	Power supply unit (PSU2)		PSU2 is the secondary PSU of the system.
5	OCP NIC card	N/A	The OCP NIC card supports OCP 3.0. The NIC ports are integrated on the OCP card which is connected to the system board and also supports the iDRAC shared NIC feature.
6	PCIe expansion card riser 4	N/A	The expansion card riser enables you to connect PCI Express expansion cards.
7	BOSS-N1 DC-MHS module	N/A	BOSS module for internal system boot.
8	PCIe expansion card riser 2	N/A	The expansion card riser enables you to connect PCI Express expansion cards.
9	iDRAC dedicated port		Enables you to remotely access iDRAC. When the front iDRAC port is connected to the network, the rear

Table 12. Rear view of the system with rear I/O configuration (continued)

items	Ports, panels, or slots	Icon	Description
			iDRAC port is automatically disabled.
10	USB 3.0 port		The USB port is 9-pin and 3.0-compliant. This port enables you to connect USB devices to the system.
11	VGA port		Enables you to connect a display device to the system.
12	Power supply unit (PSU1)		PSU1 is the primary PSU of the system.

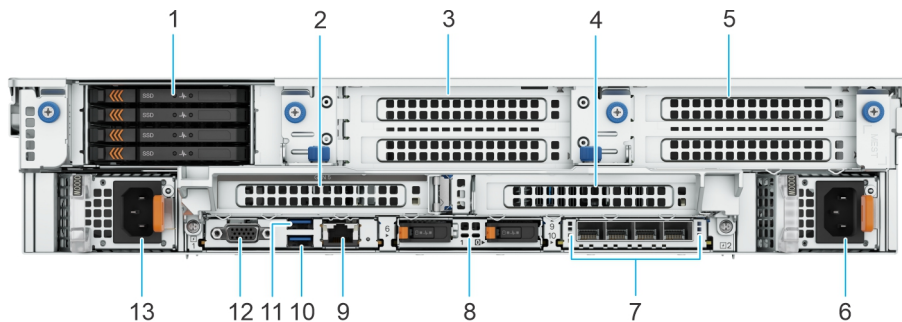

Figure 13. Rear view of the system with rear EDSFF E3.S NVMe drives

Table 13. Rear view of the system with rear EDSFF E3.S NVMe drives







items	Ports, panels, or slots	Icon	Description
1	EDSFF E3.S drives	N/A	Enables you to install drives that are supported on your system.
2	PCIe expansion card riser 2	N/A	The expansion card riser enables you to connect PCI Express expansion cards.
3	PCIe expansion card riser 3	N/A	The expansion card riser enables you to connect PCI Express expansion cards.
4	PCIe expansion card riser 4	N/A	The expansion card riser enables you to connect PCI Express expansion cards.
5	PCIe expansion card riser 5	N/A	The expansion card riser enables you to connect PCI Express expansion cards.
6	Power supply unit (PSU2)		PSU2 is the secondary PSU of the system.
7	OCP NIC card	N/A	The OCP NIC card supports OCP 3.0. The NIC ports are integrated on the OCP card which is connected to the system board and also supports the iDRAC shared NIC feature.
8	BOSS-N1 DC-MHS module	N/A	BOSS module for internal system boot.

Table 13. Rear view of the system with rear EDSFF E3.S NVMe drives (continued)

items	Ports, panels, or slots	Icon	Description
9	iDRAC dedicated port		Enables you to remotely access iDRAC. When the front iDRAC port is connected to the network, the rear iDRAC port is automatically disabled.
10	USB 3.0 port		The USB port is 9-pin and 3.0-compliant. This port enables you to connect USB devices to the system.
11	USB 3.0 port		The USB port is 9-pin and 3.0-compliant. This port enables you to connect USB devices to the system.
12	VGA port		Enables you to connect a display device to the system.
13	Power supply unit (PSU1)		PSU1 is the primary PSU of the system.

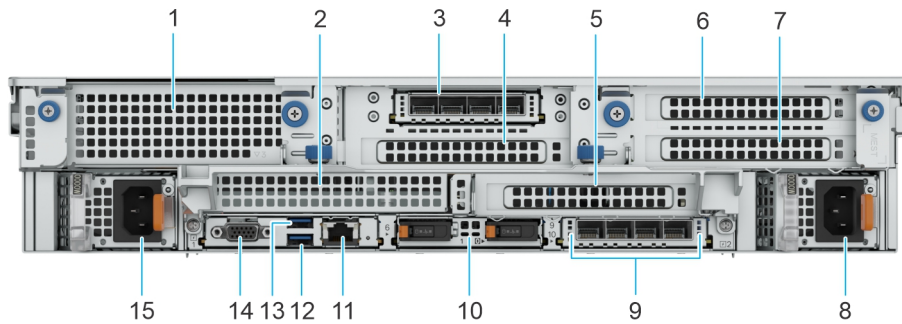









Figure 14. Rear view of the no backplane configuration system*

Table 14. Rear view of the no backplane configuration system*

items	Ports, panels, or slots	Icon	Description
1	PCIe expansion card riser 5 blank	N/A	Blank filler for the PCIe expansion riser slot.
2	PCIe expansion card riser 2 blank	N/A	Blank filler for the PCIe expansion riser slot.
3	PCIe expansion card riser OCP	N/A	PCIe expansion card riser OCP.
4	PCIe blank on expansion card riser	N/A	PCIe blank on expansion card riser
5	PCIe expansion card riser 4	N/A	The expansion card riser enables you to connect PCI Express expansion cards.
6	PCIe expansion card riser 5	N/A	The expansion card riser enables you to connect PCI Express expansion cards.
7	PCIe blank on expansion card riser	N/A	PCIe blank on expansion card riser

Table 14. Rear view of the no backplane configuration system* (continued)

items	Ports, panels, or slots	Icon	Description
8	Power supply unit (PSU2)		PSU2 is the secondary PSU of the system.
9	OCP NIC card	N/A	The OCP NIC card supports OCP 3.0. The NIC ports are integrated on the OCP card which is connected to the system board and also supports the iDRAC shared NIC feature.
10	BOSS-N1 DC-MHS module	N/A	BOSS module for internal system boot.
11	iDRAC dedicated port		Enables you to remotely access iDRAC. When the front iDRAC port is connected to the network, the rear iDRAC port is automatically disabled.
12	USB 3.0 port		The USB port is 9-pin and 3.0-compliant. This port enables you to connect USB devices to the system.
13	USB 3.0 port		The USB port is 9-pin and 3.0-compliant. This port enables you to connect USB devices to the system.
14	VGA port		Enables you to connect a display device to the system.
15	Power supply unit (PSU1)		PSU1 is the primary PSU of the system.

 **NOTE:** *Feature not available at product launch in September, 2025. Please refer to the product configurator page on [Dell.com](https://www.dell.com) to confirm feature availability.

System configurations - inside view for PowerEdge R570 system

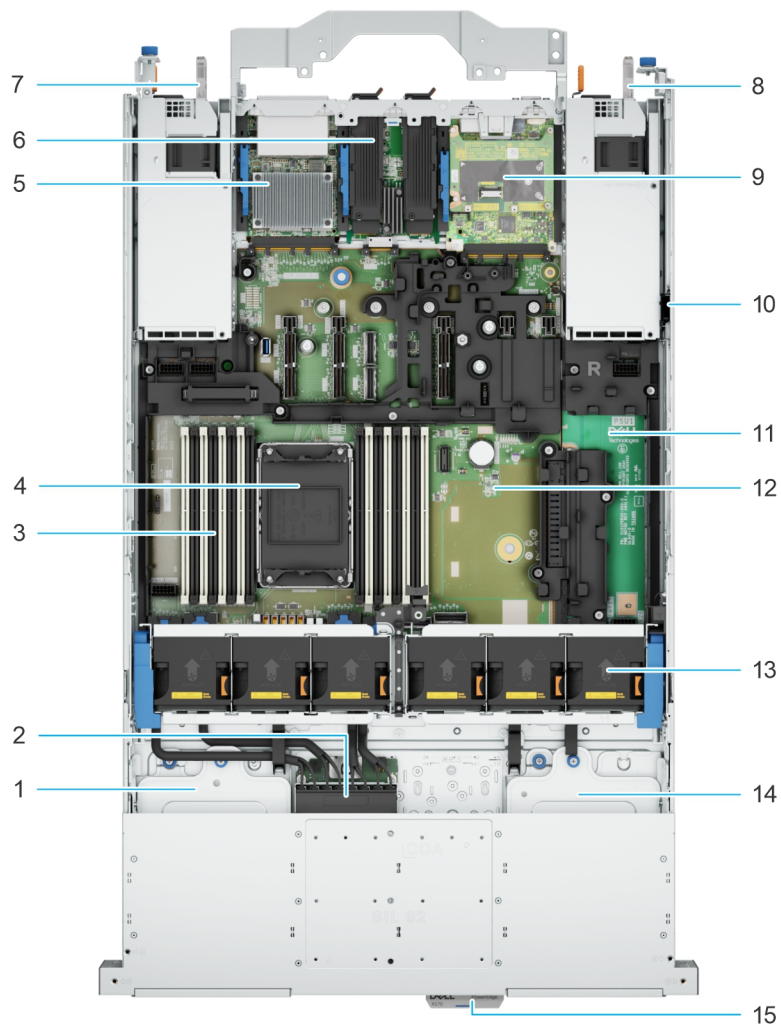

Figure 15. Inside the system

- | | |
|----------------------------------|---------------------------------|
| 1. Front OCP or Front BOSS-N1 | 2. Drive backplane |
| 3. DIMM slots | 4. Processor Heatsink Module |
| 5. OCP 3.0 NIC card | 6. BOSS-N1 DC-MHS module |
| 7. PSU 2 | 8. PSU 1 |
| 9. DC-SCM module | 10. Intrusion Switch |
| 11. Power interposer board (PIB) | 12. Host Processor Module (HPM) |
| 13. Cooling fans | 14. Front OCP |
| 15. Express Service Tag | |

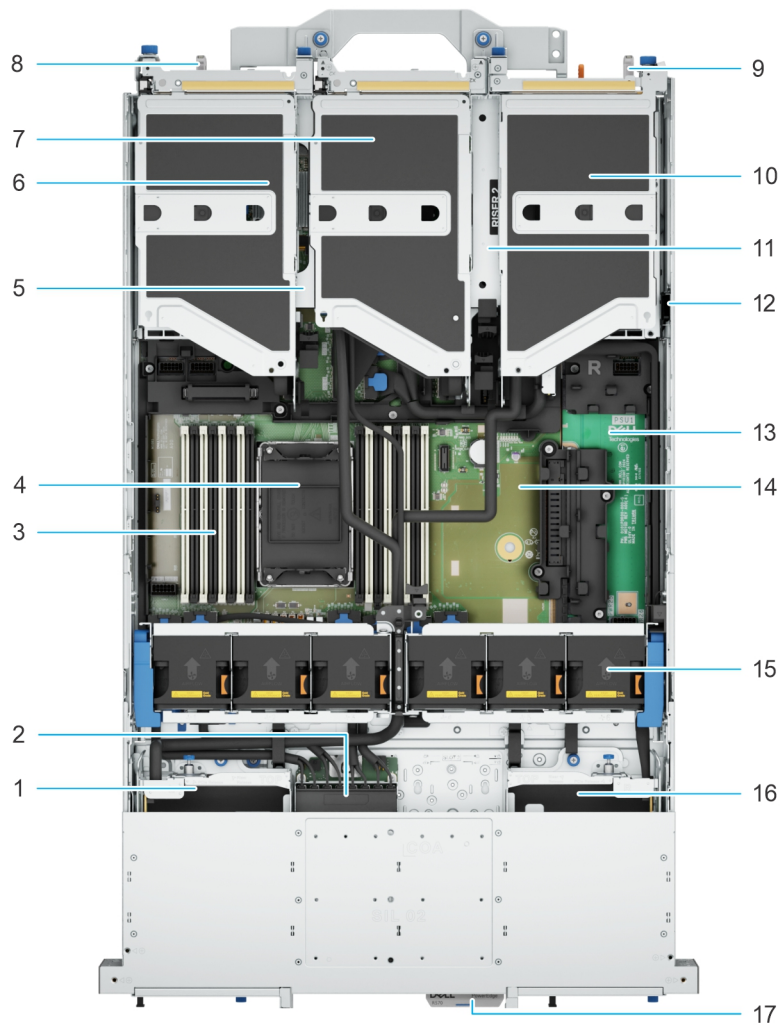

Figure 16. Inside the system with risers

- | | |
|----------------------------------|---------------------------------|
| 1. Front OCP or Front BOSS-N1 | 2. Drive backplane |
| 3. DIMM slots | 4. Processor Heatsink Module |
| 5. Riser 4 | 6. Riser 5 |
| 7. Riser 3 | 8. PSU 2 |
| 9. PSU 1 | 10. Riser 1 |
| 11. Riser 2 | 12. Intrusion Switch |
| 13. Power interposer board (PIB) | 14. Host Processor Module (HPM) |
| 15. Cooling fans | 16. Front OCP |
| 17. Express Service Tag | |

Locating the Express Service Code and Service Tag

The unique Express Service Code and Service Tag are used to identify the system.

The information tag is on the front of the system that includes system information such as the Service Tag, Express Service Code, Manufacture date, NIC, MAC address, QRL label, and so on.

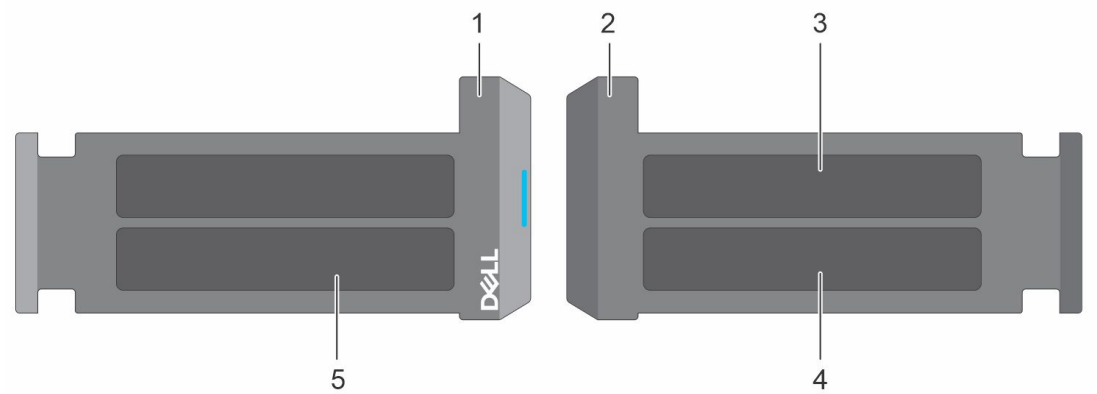

Figure 17. Locating the Express Service Code and Service tag

1. Express Service Tag (front view)
2. Express Service Tag (rear view)
3. OMM (not applicable)
4. Password MAC address
5. Service Tag, Express Service Code, My Dell QRL label

System information label

The system information label is located on the back of the system cover and/or on the top of the system.

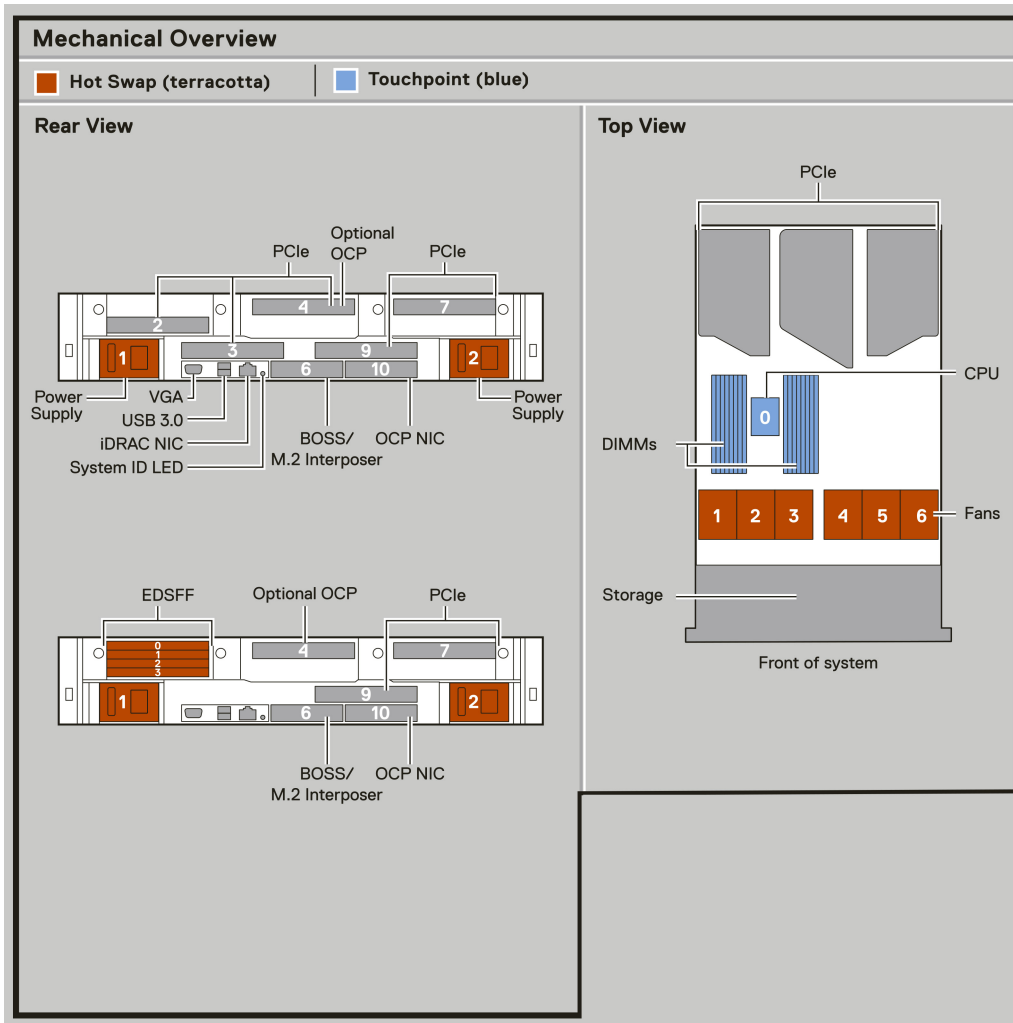

Figure 18. Mechanical overview

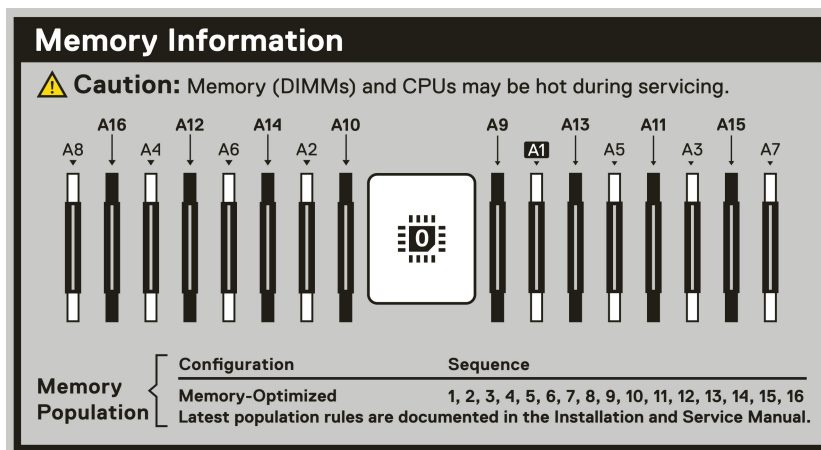

Figure 19. Memory information

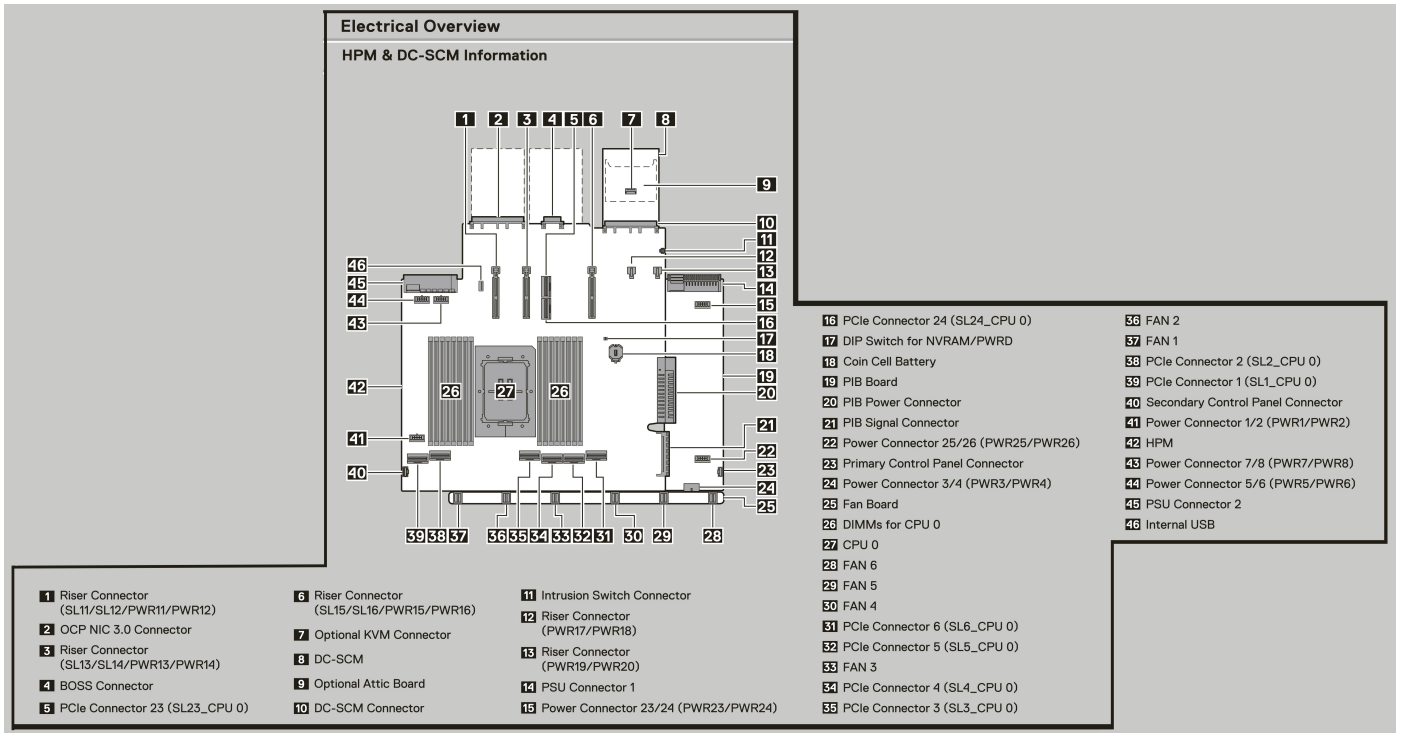

Figure 20. Electrical overview

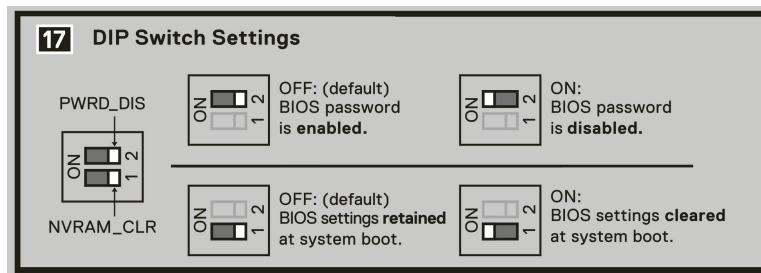

Figure 21. DIP Switch Settings

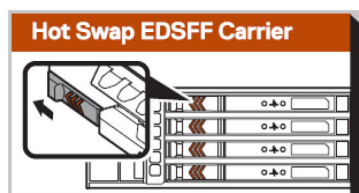

Figure 22. Hot swap EDSFF carrier

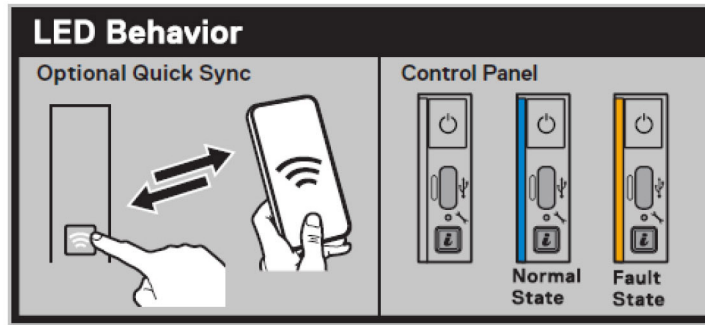

Figure 23. LED behavior 8 x 2.5 inch drives

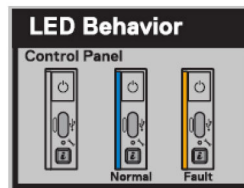

Figure 24. LED behavior E3.s drives

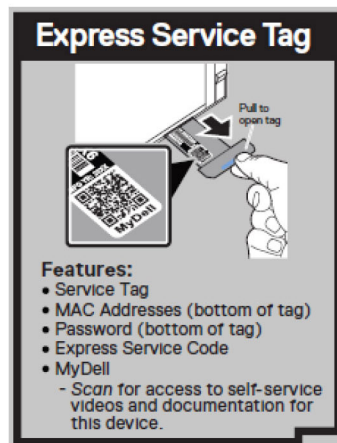

Figure 25. Express Service Tag



Figure 26. Caution

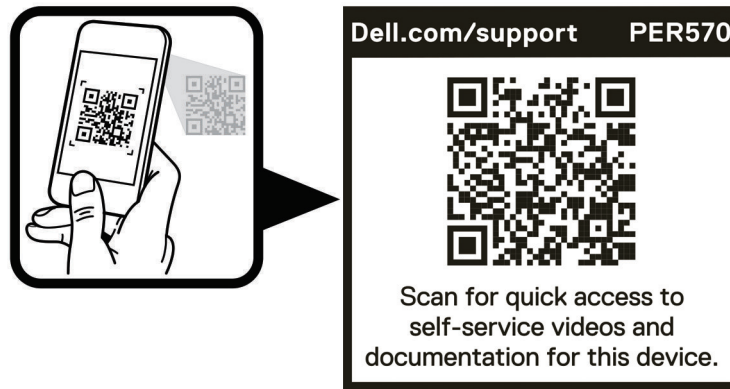

Figure 27. QRL

Rail sizing and rack compatibility matrix

For specific information about the rail solutions compatible with your system, see the *Dell Enterprise Systems Rail Sizing and Rack Compatibility Matrix* available at rail-rack-matrix.

The document provides the information that is listed below:

- Specific details about rail types and their functionalities.
- Rail adjustability range for various types of rack mounting flanges.
- Rail depth with and without cable management accessories.
- Types of racks that are supported for various types of rack mounting flanges.

Technical specifications

The technical and environmental specifications of your system are outlined in this chapter.

Topics:

- Chassis dimensions
- System weight
- Processor specifications
- PSU specifications
- Cooling fan specifications
- Supported operating systems
- System battery specifications
- Expansion card riser specifications
- Memory specifications
- Storage controller specifications
- Drives
- GPU Specifications
- Ports and connectors specifications
- Environmental specifications

Chassis dimensions

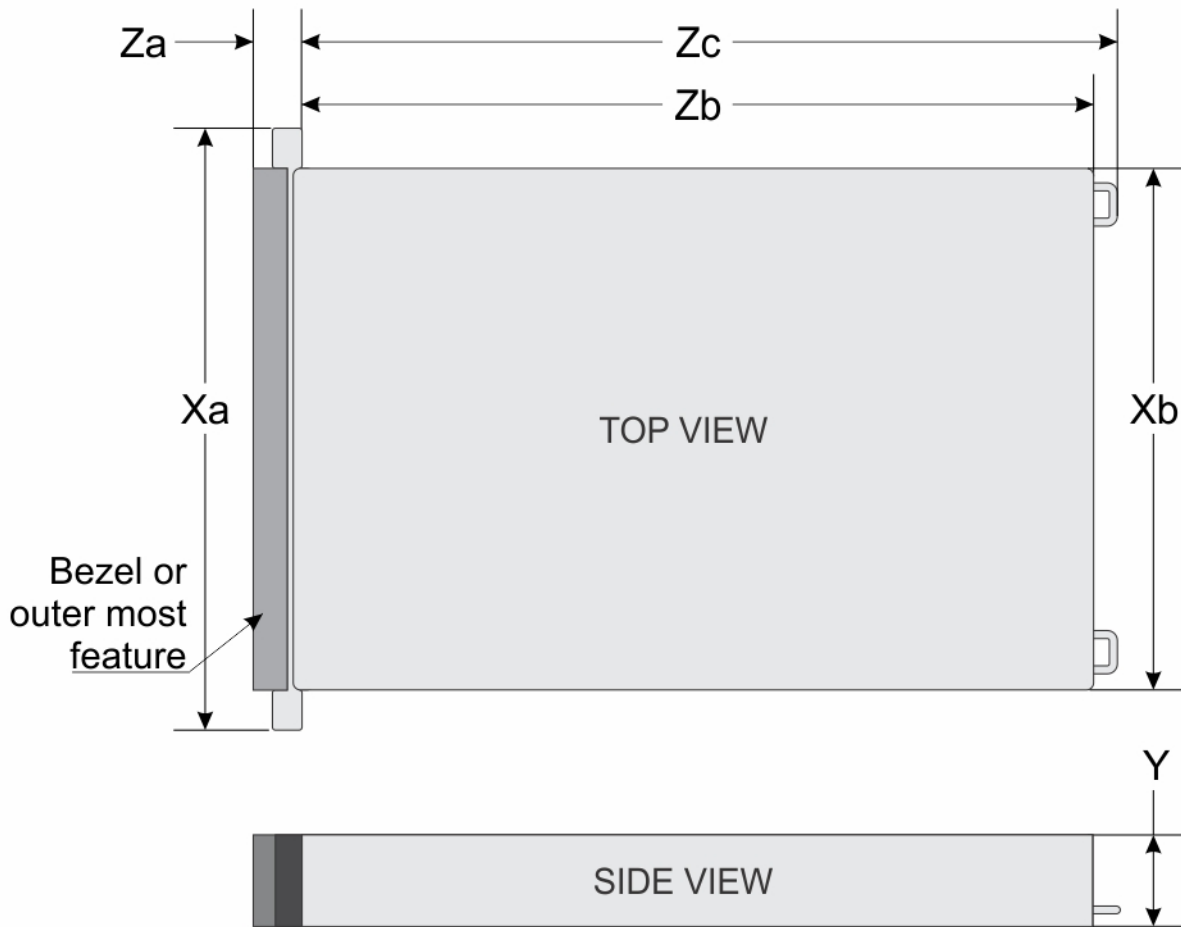

Figure 28. Chassis dimensions

Table 15. PowerEdge R570 chassis dimensions

Drives	Xa	Xb	Y	Za	Zb	Zc
8 x EDSFF E3.S drives 16 x EDSFF E3.S drives Cold aisle configurations	482 mm (19.0 inches)	434 mm (17.1 inches)	86.8 mm (3.42 inches)	42.9 mm (1.69 inches) without bezel i NOTE: Front bezel is not supported in a front I/O configuration.	700.7 mm (27.59 inches) Ear to rear wall	771.6 mm (30.4 inches)
12 x 3.5-inch drives 8 x 2.5-inch drives 16 x 2.5-inch drives 24 x 2.5-inch drives 32 x EDSFF E3.S drives	482 mm (19.0 inches)	434 mm (17.1 inches)	86.8 mm (3.42 inches)	30.78 mm (1.21 inches) with bezel 29.89 mm (1.18 inches) without bezel	700.7 mm (27.59 inches) Ear to rear wall	771.6 mm (30.4 inches)

i NOTE: Zb is the nominal rear wall external surface where the HPM board I/O connectors reside.

System weight

Table 16. PowerEdge R570 system weight

System configuration	Maximum weight (with all drives/SSDs)
8 x 2.5-inch SATA (HDD/SSD)	25.2 kg (55.5 lbs)
16 x 2.5-inch SATA (HDD/SSD)	27.1 kg (59.7 lbs)
24 x 2.5-inch SATA (HDD/SSD)	28.6 kg (63.05 lbs)
12 x 3.5-inch SATA (HDD/SDD)	31 kg (68.3 lbs)
8 x EDSFF E3.S Gen5 NVMe cold aisle configuration.	27.8 kg (61.28 lbs)
8 x EDSFF E3.S Gen5 NVMe cold aisle configuration	22.3 kg (49.16 lbs)
16 x EDSFF E3.S Gen5 NVMe cold aisle configuration	22.9 kg (50.48 lbs)
32 x EDSFF E3.S Gen5 NVMe hot aisle configuration	24.2 kg (53.35 lbs)

Table 17. PowerEdge R570 weight handling recommendations

Chassis weight	Description
40–70 lbs	Recommend two people to lift.
70–120 lbs	Recommend three people to lift.
≥ 121 lbs	Recommend to use a server-lift.

Processor specifications

Table 18. PowerEdge R570 processor specifications

Supported processor	Number of processors supported
Intel® Xeon® 6 E-core processor	One
Intel® Xeon® 6 P-core processor	One

Table 19. Minimum Firmware requirement for Intel® Xeon® 6 E-core processor and Intel® Xeon® 6 P-core processor

Processors	IDRAC	BIOS	FPGA
Intel® Xeon® 6 E-core processor	1.10.17.00	1.1.3	106.102.000
Intel® Xeon® 6 P-core processor	1.20.25.00	1.2.6	107.102.000

PSU specifications

The PowerEdge R570 system supports up to two AC or DC power supply units (PSUs).

Table 20. PSU specifications

PSU	Class	Heat dissipation (maximum) (BTU/hr)	Frequency (Hz)	AC Voltage			DC Voltage			Current (A)
				200—240 V	100—120 V	277 V	240 V	-(48—60) V	336 V	
800 W mixed mode	Platinum	3000	50/60	800 W	800 W	N/A	N/A	N/A	N/A	9.2—4.5 A
	Titanium	3000	50/60	800 W	800 W	N/A	N/A	N/A	N/A	9.2—4.5 A
	N/A	3000	N/A	N/A	N/A	N/A	800 W	N/A	N/A	3.7 A
1100 W	Titanium	4100	50/60	1100 W	1050 W	N/A	N/A	N/A	N/A	12—6.1 A
	Platinum	4100	50/60	1100 W	1050 W	N/A	N/A	N/A	N/A	12—6.1 A
	N/A	4100	N/A	N/A	N/A	N/A	1100 W	N/A	N/A	5.1 A
1400 W -48 VDC	Titanium	5310	N/A	N/A	N/A	N/A	N/A	1400 W	N/A	33 A
1500 W 227 VAC*	Titanium	5625	50/60	N/A	N/A	N/A	1500 W	N/A	N/A	6.1 A
	N/A	5625	N/A	N/A	N/A	N/A	N/A	N/A	1500 W	4.91 A
1500 W mixed mode	Titanium	5625	50/60	1500 W	1050 W	N/A	N/A	N/A	N/A	12—8.2 A
	N/A	5625	N/A	N/A	N/A	N/A	1500 W	N/A	N/A	6.8 A
1800 W mixed mode*	Titanium	6750	50/60	1800 W	1050 W	N/A	N/A	N/A	N/A	9.8—8.2 A
	N/A	6750	N/A	N/A	N/A	N/A	1800 W	N/A	N/A	8.2 A

- NOTE:** Heat dissipation is calculated using the PSU wattage rating.
- NOTE:** When selecting or upgrading the system configuration, to ensure optimum power utilization, verify the system power consumption with the Enterprise Infrastructure Planning Tool available at [calc](#).
- NOTE:** If a system with AC 1500 W PSUs operates at low line 100-120 Vac, then the power rating per PSU is degraded to 1050 W.



Figure 29. PSU power cables

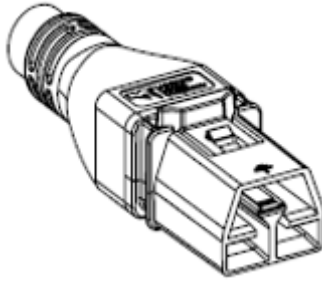

Figure 30. APP 2006G1 power cable



Figure 31. LOTES APOWA048 power cable

Table 21. PSU power cables

Form factor	Output	Power cable
Redundant 60 mm	800 W mixed mode	C13
	1100w mixed mode	C13
	1400w -48v DC	LOTES APOWA048
	1500 W mixed mode	C13
	1500w 277v*	APP2006G1/2006G3
	1800 W mixed mode*	C13

NOTE: *Feature not available at product launch in September, 2025. Please refer to the product configurator page on Dell.com to confirm feature availability.

Cooling fan specifications

The PowerEdge R570 system supports up to six cooling fans.

Table 22. Cooling fan specifications

Fan type	Abbreviation	Also known as	Label color	Label image
High Performance Silver (HPR Silver) fans	HPR SLVR	Silver	Silver	

Table 22. Cooling fan specifications (continued)

Fan type	Abbreviation	Also known as	Label color	Label image
High Performance Gold (HPR Gold) fans	HPR GOLD	Gold	Gold	

NOTE: Cooling fans rotate at a slower speed, even while the system is in standby mode, and the fan speed varies in response to changes in the ambient temperature.

Supported operating systems

The PowerEdge R570 system supports the following operating systems:

- Canonical Ubuntu Server LTS
- RedHat Enterprise Linux
- SUSE Linux Enterprise Server
- VMware ESXi
- Windows Server
- Windows Server Datacenter

For specifications and interoperability details, see [OS support](#).

System battery specifications

The PowerEdge R570 system uses one CR 2032 3.0-V lithium coin cell battery.

Expansion card riser specifications

The PowerEdge R570 system supports up to four PCI express (PCIe) slots (Gen5 slots), dual OCP NIC, and BOSS on the HPM board.

Table 23. Expansion card slots supported on the HPM board

PCIe slot	Expansion card riser	Processor connection	Height	Length	Slot width
Slot 2	R1x	Processor 0	Full Height	Half Length	x16
Slot 3	R2t	Processor 0	Full Height	Half Length	x16
Slot 4	R3e (Flop OCP) R3f (Flop OCP)	Processor 0	N/A	N/A	x16
Slot 6	BOSS (optional)	Processor 0	N/A	N/A	x4
Slot 7	R5b	Processor 0	Full Height	Half Length	x16
Slot 9	R4b	Processor 0	Full Height	Half Length	x16
Slot 10	Onboard OCP (optional)	Processor 0	N/A	N/A	x16
Slot 31	RF1a	Processor 0	Full Height	Half Length	x16

Table 23. Expansion card slots supported on the HPM board (continued)

PCIe slot	Expansion card riser	Processor connection	Height	Length	Slot width
Slot 34	RF2a (Flop OCP) BOSS (optional)	Processor 0	N/A	N/A	x16/x4
Slot 36	RF3c	Processor 0	Full Height	Half Length	x16
Slot 38	RF4b (Flop OCP)	Processor 0	N/A	N/A	x16

Memory specifications

The PowerEdge R570 system supports the following memory specifications for optimized operation.

Table 24. Memory specifications

DIMM type	Rank	Capacity	Single Processor			
			Intel® Xeon 6 E- core processor		Intel® Xeon 6 P- core processor	
			Minimum system capacity	Maximum system capacity	Minimum system capacity	Maximum system capacity
RDIMM	1 R	16 GB	N/A	N/A	16 GB	128 GB
	2 R	32 GB	32 GB	256 GB	32 GB	512 GB
		64 GB	512 GB	1 TB	256 GB	1 TB
		96 GB	N/A	N/A	768 GB	1.5 TB
		128 GB	N/A	N/A	1 TB	2 TB
	8 R	256 GB	N/A	N/A	4 TB	4 TB

NOTE: The RDIMM configuration depends on the DIMM capacity and the processor combination. Refer the [System memory guidelines](#) for more information.

Table 25. Memory module sockets

Memory module sockets	Speed
16 DDR5 DIMM slots	6400 MT/s (1DPC) 5200 MT/s (2DPC)

NOTE: Memory DIMM slots are not hot pluggable.

NOTE: The processor may reduce the performance of the rated DIMM speed.

Storage controller specifications

The PowerEdge R570 system supports the following controller cards:

Table 26. Storage controller cards

Supported storage controller cards
Internal controllers <ul style="list-style-type: none"> PERC H365i DC-MHS Front

Table 26. Storage controller cards (continued)

Supported storage controller cards
<ul style="list-style-type: none">• PERC H965i DC-MHS Front• PERC H365i adapter• PERC H965i adapter
External controllers <ul style="list-style-type: none">• PERC H965e• HBA 465e
Internal boot <ul style="list-style-type: none">• Boot Optimized Storage Subsystem (BOSS-N1 DC-MHS)• M.2 interposer with up to 2 x M.2 NVMe SSDs• USB
Software RAID <ul style="list-style-type: none">• N/A

Drives

The PowerEdge R570 system supports:

- Up to 12 x 3.5-inch SATA (HDD) RAID hot-swappable drives + 4 x EDSFF E3.S Gen5 NVMe hot-swappable drives
- 8 x 2.5-inch NVMe (SSD) RAID hot-swappable drives
- 8 x 2.5-inch NVMe (SSD) hot-swappable drives
- 8 x 2.5-inch SATA (HDD/SSD) hot-swappable drives
- 8 x 2.5-inch SATA/Universal (HDD/SSD) hot-swappable drives
- 16 x 2.5-inch SATA (HDD/SSD) RAID hot-swappable drives
- 24 x 2.5-inch SATA (HDD/SSD) hot-swappable drives
- 8 x EDSFF E3.S (hot-aisle) Gen5 NVMe hot-swappable drives
- 8 x EDSFF E3.S (cold-aisle) Gen5 NVMe hot-swappable drives
- 16 x EDSFF E3.S (cold-aisle) Gen5 NVMe hot-swappable drives
- 16 x EDSFF E3.S (hot-aisle) Gen5 NVMe hot-swappable drives
- 32 x EDSFF E3.S (hot-aisle) Gen5 NVMe hot-swappable drives

i **NOTE:** For more information about how to hot swap NVMe PCIe SSD device, see the *Dell Express Flash NVMe PCIe SSD User's Guide* at [Dell Support](#) page > **Browse all products** > **Infrastructure** > **Data Center Infrastructure** > **Storage Adapters & Controllers** > **Dell PowerEdge Express Flash NVMe PCIe SSD** > **Select This Product** > **Documentation** > **Manuals and Documents**.

GPU Specifications

The PowerEdge R570 system supports

- Up to four NVIDIA L4 24 GB 72 W single-width GPUs
- Up to three NVIDIA L40S 48 GB 350 W double-width GPUs
- Up to three NVIDIA H100 NVL 94 GB 400 W double-width GPUs

Ports and connectors specifications

NIC port specifications

The PowerEdge R570 system supports one 10/100/1000 Mbps BMC Ethernet and two optional Open Compute Project (OCP) cards.

Table 27. NIC port specification for the system

Feature	Specifications
Datacenter-Secure Control Module (DC-SCM)	1 GbE x 1
OCP NIC 3.0 card	100 GbE x 2, 25 GbE x 2, 25 GbE x 4, 10 GbE x 2, 10 GbE x 4, 1 GbE x 4

USB ports specifications

Table 28. PowerEdge R570 USB specifications

Front		Rear		Internal (Optional)	
USB port type	No. of ports	USB port type	No. of ports	USB port type	No. of ports
USB 2.0-compliant port (optional)	One	USB 3.1-compliant port	Two	Internal USB 3.1-compliant port	One
USB type C dual-mode host/BMC Direct port	One				

Serial connector specifications

The PowerEdge R570 system supports one optional card type connector, which is a 9 - pin connector, Data Terminal Equipment (DTE), 16550-compliant.

The optional serial connector card is available only in front I/O configuration.

Top USB port on DC-SCM supports external DB9 Dongle.

Video ports specifications

The PowerEdge R570 system supports one DB-15 VGA port (optional) on the rear I/O board and one Mini Display (mDP) port (optional) on the Left Control Panel (LCP) .

 **NOTE:** Both ports cannot be used together. The mDP port overrides the VGA port.

Video specifications

Table 29. Supported video resolution options

Resolution	Refresh Rate	Color depth (bits)
1024 x 768	60	8, 16, 32
1280 x 800	60	8, 16, 32
1280 x 1024	60	8, 16, 32
1360 x 768	60	8, 16, 32
1440 x 900	60	8, 16, 32
1600 x 900	60	8, 16, 32
1600 x 1200	60	8, 16, 32
1680 x 1050	60	8, 16, 32
1920 x 1080	60	8, 16, 32

Table 29. Supported video resolution options (continued)

Resolution	Refresh Rate	Color depth (bits)
1920 x 1200	60	8, 16, 32

Environmental specifications

NOTE: For additional information about environmental certifications, refer to the *Product Environmental Datasheet* located with the **Manuals & Documents** on [Dell Support](#).

Table 30. Continuous Operation Specifications for ASHRAE A2

Parameters	Allowable continuous operations
Temperature range for altitudes <= 900 m (<= 2953 ft)	10–35°C (50–95°F) with no direct sunlight on the equipment
Humidity percent range (non-condensing at all times)	8% RH with -12°C minimum dew point to 80% RH with 21°C (69.8°F) maximum dew point
Operational altitude de-rating	Maximum temperature is reduced by 1°C/300 m (1.8°F/984 ft) above 900 m (2953 ft)

Table 31. Continuous Operation Specifications for ASHRAE A3

Parameters	Allowable continuous operations
Temperature range for altitudes <= 900 m (<= 2953 ft)	5–40°C (41–104°F) with no direct sunlight on the equipment
Humidity percent range (non-condensing at all times)	8% RH with -12°C minimum dew point to 85% RH with 24°C (75.2°F) maximum dew point
Operational altitude de-rating	Maximum temperature is reduced by 1°C/175 m (1.8°F/574 Ft) above 900 m (2953 Ft)

Table 32. Continuous Operation Specifications for ASHRAE A4

Parameters	Allowable continuous operations
Temperature range for altitudes <= 900 m (<= 2953 ft)	5–45°C (41–113°F) with no direct sunlight on the equipment
Humidity percent range (non-condensing at all times)	8% RH with -12°C minimum dew point to 90% RH with 24°C (75.2°F) maximum dew point
Operational altitude de-rating	Maximum temperature is reduced by 1°C/125 m (1.8°F/410 Ft) above 900 m (2953 Ft)

Table 33. Continuous Operation Specifications for Rugged Environment

Parameters	Allowable continuous operations
Temperature range for altitudes <= 900 m (<= 2953 ft)	5–55°C (41–131°F) with no direct sunlight on the equipment
Humidity percent range (non-condensing at all times)	8% RH with -12°C minimum dew point to 90% RH with 24°C (75.2°F) maximum dew point
Operational altitude de-rating	Maximum temperature is reduced by 1°C/125 m (1.8°F/410 Ft) above 900 m (2953 Ft)

Table 34. Common Environmental Specifications for ASHRAE A2, A3, A4, and Rugged

Parameters	Allowable continuous operations
Maximum temperature gradient (applies to both operation and non-operation)	20°C in an hour* (36°F in an hour) and 5°C in 15 minutes (41°F in 15 minutes), 5°C in an hour* (41°F in an hour) for tape <i>i</i> NOTE: * - Per ASHRAE thermal guidelines for tape hardware, these are not instantaneous rates of temperature change.
Non-operational temperature limits	-40°C to 65°C (-40°F to 149°F)
Non-operational humidity limits	5% to 95% RH with 27°C (80.6°F) maximum dew point
Maximum non-operational altitude	12,000 meters (39,370 ft)
Maximum operational altitude	3,048 meters (10,000 ft)

Table 35. Maximum vibration specifications

Maximum vibration	Specifications
Operating	0.21 G _{rms} at 5 Hz to 500 Hz for 10 min (all x, y, and z axes)
Storage	1.38 G _{rms} at 7 Hz to 250 Hz for 15 minutes (all six sides tested)

Table 36. Maximum shock pulse specifications

Maximum shock pulse	Specifications
Operating	Six consecutively performed shock pulses in the positive and negative x, y, and z axis of 6 G for up to 11 ms.
Storage	Six consecutively performed shock pulses in the positive and negative x, y, and z axis (one pulse on each side of the system) of 71 G for up to 2 ms.

Particulate and gaseous contamination specifications

The following table defines the limitations that help avoid any equipment damage or failure from particulates and gaseous contamination. If the levels of particulates or gaseous pollution exceed the specified limitations and result in equipment damage or failure, you must rectify the environmental conditions. Remediation of environmental conditions is the responsibility of the customer.

Table 37. Particulate contamination specifications

Particulate contamination	Specifications
Air filtration: Conventional Data Center only	Data center air filtration as defined by ISO Class 8 per ISO 14644-1 with a 95% upper confidence limit <i>i</i> NOTE: Filtering room air with a MERV8 filter, as specified in ANSI/ASHRAE Standard 127, is a recommended method for achieving the necessary environmental conditions. <i>i</i> NOTE: Air entering the data center must have MERV11 or MERV13 filtration. <i>i</i> NOTE: This condition applies to data center environments only. Air filtration requirements do not apply to IT equipment designed to be used outside a data center, in environments such as an office or factory floor.
Walk-Up Edge Data Center or Cabinet (sealed, closed loop environment)	Filtration is not required for cabinets that are anticipated to be opened six times or less per year. Class 8 per ISO 1466-1 filtration as defined above is required otherwise. <i>i</i> NOTE: In environments commonly above ISA-71 Class G1 or that may have known challenges, special filters may be required.

Table 37. Particulate contamination specifications (continued)

Particulate contamination	Specifications
Conductive dust: data center and non-data center environments	<p>Air must be free of conductive dust, zinc whiskers, or other conductive particles.</p> <p>i NOTE: Conductive dust, which can interfere with equipment operation, can originate from various sources, including manufacturing processes and zinc whiskers that may develop on the plating of raised floor tiles.</p> <p>i NOTE: This condition applies to data center and non-data center environments.</p>
Corrosive dust: data center and non-data center environments	<ul style="list-style-type: none"> • Air must be free of corrosive dust. • Residual dust present in the air must have a deliquescent point less than 60% relative humidity. <p>i NOTE: This condition applies to data center and non-data center environments.</p>

Table 38. Gaseous contamination specifications

Gaseous contamination	Specifications	Notes
Copper coupon corrosion rate	ISA-71 Class G1: <300 Å/month	Per ANSI/ISA71.04
Silver coupon corrosion rate	ISA-71 Class G1: <200 Å/month	Per ANSI/ISA71.04

Thermal restriction matrix

Table 39. Label reference

Label	Description
STD	Standard
HPR	High performance
HPR Silver	High performance (HPR) Silver fan
HPR Gold	High Performance (HPR) Gold fan
HSK	Heat sink
LP	Low profile
FH	Full height
EXT	Extended

Table 40. Processor and heat sink matrix

Heat sink	Processor TDP
2U STD HSK	<ul style="list-style-type: none"> • Require a regular shroud • CPU TDP ≤150 W in Non 12x3.5" configuration
HPR HSK	<ul style="list-style-type: none"> • Require a regular shroud • CPU TDP > 150 W or all CPUs in 12x3.5" configuration

i **NOTE:** The configuration's ambient temperature is dictated by its critical component. For example, if the processor's ambient temperature is 35°C, the DIMM is 35°C, and the GPU is 30°C, the configuration's ambient temperature can only be 30°C.

Table 41. Thermal restriction matrix for air cooling (non - GPU)

Configuration		Cold Aisle 8 x E3.S 16 x E3.S	8 x 2.5- inch NVMe	12 x 3.5- inch SAS/ SATA	12 x 3.5- inch SAS/ SATA	16 x 2.5- inch drives 24 x 2.5- inch drives	Hot Aisle 8 x E3.S 16 x E3.S	Hot Aisle 32 x E3.S	Ambient tempera ture
Rear storage		No rear drives	No rear drives	Rear 4 x E3.S	No rear drives	No rear drives	No rear drives	No rear drives	
Shroud		Regular Shroud							
Process or	TDP/ cTDP	Fan/HSK							
6710E	205 W	HPR Silver fan HPR HSK	HPR Silver fan HPR HSK	HPR Gold fan HPR HSK	HPR Gold fan HPR HSK	HPR Silver fan HPR HSK	HPR Silver fan HPR HSK	HPR Gold fan HPR HSK	35°C
6756E	225 W	HPR Silver fan HPR HSK	HPR Silver fan HPR HSK	HPR Gold fan HPR HSK	HPR Gold fan HPR HSK	HPR Silver fan HPR HSK	HPR Silver fan HPR HSK	HPR Gold fan HPR HSK	35°C
6740E/ 6766E/ 6731E/ 6746E	250 W	HPR Silver fan HPR HSK	HPR Silver fan HPR HSK	HPR Gold fan HPR HSK	HPR Gold fan HPR HSK	HPR Silver fan HPR HSK	HPR Silver fan HPR HSK	HPR Gold fan HPR HSK	35°C
6780E	330 W	HPR Silver fan HPR HSK	HPR Silver fan HPR HSK	HPR Gold fan HPR HSK	HPR Gold fan HPR HSK	HPR Silver fan HPR HSK	HPR Silver fan HPR HSK	HPR Gold fan HPR HSK	35°C
6507P/ 6505P/ 6511P	150 W	HPR Silver fan STD HSK	HPR Silver fan STD HSK	HPR Gold fan HPR HSK	HPR Gold fan HPR HSK	HPR Silver fan STD HSK	HPR Silver fan STD HSK	HPR Gold fan STD HSK	35°C
6517P	190 W	HPR Silver fan HPR HSK	HPR Silver fan HPR HSK	HPR Gold fan HPR HSK	HPR Gold fan HPR HSK	HPR Silver fan HPR HSK	HPR Silver fan HPR HSK	HPR Gold fan HPR HSK	35°C
6724P	210 W	HPR Silver fan HPR HSK	HPR Silver fan HPR HSK	HPR Gold fan HPR HSK	HPR Gold fan HPR HSK	HPR Silver fan HPR HSK	HPR Silver fan HPR HSK	HPR Gold fan HPR HSK	35°C
6521P	225 W	HPR Silver fan HPR HSK	HPR Silver fan HPR HSK	HPR Gold fan HPR HSK	HPR Gold fan HPR HSK	HPR Silver fan HPR HSK	HPR Silver fan HPR HSK	HPR Gold fan HPR HSK	35°C
6731P	245 W	HPR Silver fan HPR HSK	HPR Silver fan HPR HSK	HPR Gold fan HPR HSK	HPR Gold fan HPR HSK	HPR Silver fan HPR HSK	HPR Silver fan HPR HSK	HPR Gold fan HPR HSK	35°C
6527P	255 W	HPR Silver fan HPR HSK	HPR Silver fan	HPR Gold fan	HPR Gold fan	HPR Silver fan	HPR Silver fan	HPR Gold fan	35°C

Table 41. Thermal restriction matrix for air cooling (non - GPU) (continued)

Configuration		Cold Aisle 8 x E3.S 16 x E3.S	8 x 2.5-inch NVMe	12 x 3.5-inch SAS/ SATA	12 x 3.5-inch SAS/ SATA	16 x 2.5-inch drives 24 x 2.5-inch drives	Hot Aisle 8 x E3.S 16 x E3.S	Hot Aisle 32 x E3.S	Ambient tempera ture
Rear storage		No rear drives	No rear drives	Rear 4 x E3.S	No rear drives	No rear drives	No rear drives	No rear drives	
Shroud		Regular Shroud							
Process or	TDP/ cTDP	Fan/HSK							
			HPR HSK	HPR HSK	HPR HSK	HPR HSK	HPR HSK	HPR HSK	
6737P	270 W	HPR Silver fan HPR HSK	HPR Silver fan HPR HSK	HPR Gold fan HPR HSK	HPR Gold fan HPR HSK	HPR Silver fan HPR HSK	HPR Silver fan HPR HSK	HPR Gold fan HPR HSK	35°C
6730P	250 W	HPR Silver fan HPR HSK	HPR Silver fan HPR HSK	HPR Gold fan HPR HSK	HPR Gold fan HPR HSK	HPR Silver fan HPR HSK	HPR Silver fan HPR HSK	HPR Gold fan HPR HSK	35°C
6741P	300 W	HPR Silver fan HPR HSK	HPR Silver fan HPR HSK	HPR Gold fan HPR HSK	HPR Gold fan HPR HSK	HPR Silver fan HPR HSK	HPR Silver fan HPR HSK	HPR Gold fan HPR HSK	35°C
6747P	330 W	HPR Silver fan HPR HSK	HPR Silver fan HPR HSK	HPR Gold fan HPR HSK	HPR Gold fan HPR HSK	HPR Silver fan HPR HSK	HPR Silver fan HPR HSK	HPR Gold fan HPR HSK	35°C
6787P/ 6767P/ 6781P/ 6761P	350 W	HPR Silver fan HPR HSK	HPR Silver fan HPR HSK	HPR Gold fan HPR HSK	HPR Gold fan HPR HSK	HPR Silver fan HPR HSK	HPR Silver fan HPR HSK	HPR Gold fan HPR HSK	35°C
Memory		Ambient Temperature							
16 GB RDIMM		35°C	35°C	35°C	35°C	35°C	35°C	35°C	35°C
32 GB RDIMM		35°C	35°C	35°C	35°C	35°C	35°C	35°C	35°C
64 GB RDIMM		35°C	35°C	35°C	35°C	35°C	35°C	35°C	35°C
96 GB RDIMM		35°C	35°C	35°C	35°C	35°C	35°C	35°C	35°C
128 GB RDIMM		35°C	35°C	35°C	35°C	35°C	35°C	35°C	35°C

Table 42. Thermal restriction matrix for air cooling (GPU)

Configuration		Cold Aisle 8 x E3.S 16 x E3.S	Ambient temperature
Rear storage		No rear drives	
Shroud		GPU Shroud	
Processor	TDP/cTDP	Fan/HSK	
6710E	205 W	HPR Gold fan 1U EXT HSK	35°C
6756E	225 W	HPR Gold fan 1U EXT HSK	35°C
6740E/6766E/6731E/ 6746E	250 W	HPR Gold fan 1U EXT HSK	35°C
6780E	330 W	HPR Gold fan 1U EXT HSK	35°C
6507P/6505P/6511P	150 W	HPR Gold fan 1U EXT HSK	35°C
6517P	190 W	HPR Gold fan 1U EXT HSK	35°C
6724P	210 W	HPR Gold fan 1U EXT HSK	35°C
6521P	225 W	HPR Gold fan 1U EXT HSK	35°C
6731P	245 W	HPR Gold fan 1U EXT HSK	35°C
6527P	255 W	HPR Gold fan 1U EXT HSK	35°C
6737P	270 W	HPR Gold fan 1U EXT HSK	35°C
6730P	250 W	HPR Gold fan 1U EXT HSK	35°C
6741P	300 W	HPR Gold fan 1U EXT HSK	35°C

Table 42. Thermal restriction matrix for air cooling (GPU) (continued)

Configuration		Cold Aisle 8 x E3.S 16 x E3.S	Ambient temperature
Rear storage		No rear drives	
Shroud		GPU Shroud	
Processor	TDP/cTDP	Fan/HSK	
6747P	330 W	HPR Gold fan 1U EXT HSK	35°C
6787P/6767P/6781P/ 6761P	350 W	HPR Gold fan 1U EXT HSK	30°C
Memory		Ambient Temperature	
16 GB RDIMM		35°C	35°C
32 GB RDIMM		35°C	35°C
64 GB RDIMM		35°C	35°C
96 GB RDIMM		35°C	35°C
128 GB RDIMM		35°C	35°C

Thermal air restrictions

ASHRAE A3/A4

- Two PSUs are required in redundant mode, however a single PSU failure is not supported.
- NVMe drive including U.2 and E3.S is not supported.
- 128 GB or greater capacity DIMMs are not supported.
- GPU and FPGA are not supported.
- CPU TDP \geq 190 W is not supported.
- Rear drives are not supported.
- Non-Dell qualified peripheral cards and/or peripheral cards greater than 25 W are not supported.
- 12 x 3.5-inch SAS/SATA drive configuration is not supported.
- M.2 module is not supported.
- OCP card with a transmission rate higher than 25G is not supported.
- NIC/OCP transceiver specification \leq 75°C is not supported.
- PERC adapter card with battery is not supported.

NVIDIA L4 GPU

- In 24 x 2.5-inch drive and 32 x E3.S drive configurations, L4 with \geq 270W CPU , it is limited at max ambient 30°C support and with \leq 250W CPU can support max ambient 35°C.
- L4 cannot be supported in a 12 x 3.5-inch drive configurations.
- L4 can be supported at max ambient 35°C. However, with \geq 300 W CPU SKUs, it is limited at max ambient 30°C support.

NVIDIA H100 NVL GPU

- H100 NVL is dedicated to cold aisle 8 x E3.S drive configuration.

- H100 NVL cannot be supported in a 12 x 3.5-inch, 24 x 2.5- Inch and 32 x E3.S drive configurations.
- H100 NVL can be supported at max ambient 35°C. However, with ≥ 300 W CPU SKUs, it is limited at max ambient 30°C support.

PCIe card Restrictions

- 12x3.5-inch, 24 x 2.5-inch and 32 x E3.S drive configuration requires the optical transceiver with higher temperature spec ≥ 85C support.
- DPU, 100 Gb network adapter, or 100 Gb OCP is not supported in 12x3.5” drive configuration.
- NVIDIA B3220 200G DPU requires a passive copper cable transceiver – MCP1650-H0XXXXXX .
- 200G Broadcom network adaptor or OCP (250P7 / T635T) requires the optical transceiver with higher temperature spec (≥ 85C) support .

Table 43. Air cooling configuration thermal restriction for AHSRAE A3 and A4

ASHRAE	A3/40°C (104°F)	A4/45°C (113°F)
PSU	Two PSUs are required in redundant mode. Single PSU failure is not supported.	
PCIe card	Non-Dell qualified peripheral cards and peripheral cards greater than 25 W are not supported.	
GPU/FPGA	Not supported	
DIMM	128 GB, or greater capacity DIMMs are not supported.	
Front storage	12 x 3.5-inch SAS/SATA configuration is not supported.	
E3.S drive	E3.S drive configuration is not supported.	
U.2 NVMe drive	U.2 NVMe drive configuration is not supported.	
M.2 Module	M.2 module is not supported.	
Rear storage	Not supported	
Processor	CPU TDP ≥ 190 W is not supported.	
PERC	PERC adapter card with battery is not supported.	
NIC/OCP	transceiver spec ≤ 75 W is not supported.	

Initial system setup and configuration

This section describes the tasks for initial setup and configuration of the Dell system. The section also provides general steps to set up the system and the reference guides for detailed information.

Topics:

- [Setting up the system](#)
- [iDRAC configuration](#)
- [Resources to install operating system](#)

Setting up the system

Perform the following steps to set up the system:

Steps

1. Unpack the system.
2. Install the system into the rack. For more information, see the rail installation and cable management accessory guides relevant to your rail and cable management solution at [PowerEdge Manuals](#).
3. Connect the peripherals to the system and the system to the electrical outlet.
4. Power on the system.

For more information about setting up the system, see the *Getting Started Guide* that is shipped with your system.

 **NOTE:** For information about managing the basic settings and features of the system, see the [Pre-operating system management applications](#) chapter.

iDRAC configuration

The Integrated Dell Remote Access Controller (iDRAC) is designed to make you more productive as a system administrator and improve the overall availability of Dell servers. iDRAC alerts you to system issues, helps you to perform remote management, and reduces the need for physical access to the system.

Options to set up iDRAC IP address

To enable communication between your system and iDRAC, you must first configure the network settings based on your network infrastructure. The network settings option is set to **DHCP**, by default.



 **NOTE:** For static IP configuration, you must request for the settings at the time of purchase.

You can set up the iDRAC IP address using one of the interfaces in the table below. For information about setting up iDRAC IP address, see the documentation links provided in the table below.

Table 44. Interfaces to set up iDRAC IP address

Interface	Documentation links
iDRAC Settings utility	Integrated Dell Remote Access Controller User's Guide at iDRAC Manuals or for system-specific Integrated Dell Remote Access Controller User's Guide, go to PowerEdge Manuals > Product Support page of your system > Documentation .

Table 44. Interfaces to set up iDRAC IP address (continued)

Interface	Documentation links
	<p> NOTE: To determine the most recent iDRAC release for your platform and for the latest documentation version, see KB article KB305325.</p>
iDRAC Direct	<p>Integrated Dell Remote Access Controller User's Guide at iDRAC Manuals or for system-specific Integrated Dell Remote Access Controller User's Guide, go to PowerEdge Manuals > Product Support page of your system > Documentation.</p> <p> NOTE: To determine the most recent iDRAC release for your platform and for the latest documentation version, see KB article KB305325.</p>

 **NOTE:** To access iDRAC, ensure that you connect the USB 2.0 Type-C cable to the iDRAC dedicated port on the front of the system.

Options to log in to iDRAC

To log in to the iDRAC Web User Interface, open a browser and enter the IP address.

You can log in to iDRAC as:

- iDRAC user
- Microsoft Active Directory user
- Lightweight Directory Access Protocol (LDAP) user

In the login screen displayed, if you have opted for secure default access to iDRAC, the default username is `root` and enter the iDRAC secure default password available on back of the Information Tag. If you opted for legacy password, use the iDRAC legacy username and password - `root` and `calvin`, the iDRAC default password will be blank on the information tag. Then you will be prompted and required to create a password of your choice before proceeding. You can also log in by using your Single Sign-On or Smart Card.

 **NOTE:** Ensure that you change the default username and password after setting up the iDRAC IP address.

For more information about logging in to the iDRAC and iDRAC licenses, see the latest [Integrated Dell Remote Access Controller User's Guide](#)

 **NOTE:** To determine the most recent iDRAC release for your platform and for latest documentation version, see KB article [KB78115](#).

You can also access iDRAC using command-line protocol - RACADM. For more information, see the [Integrated Dell Remote Access Controller RACADM CLI Guide](#).

You can also access iDRAC using automation tool - Redfish API. For more information, see the [Integrated Dell Remote Access Controller User's Guide Redfish API Guide](#).

Resources to install operating system

If the system is shipped without an operating system, you can install a supported operating system by using one of the resources that are provided in the table below. For information about how to install the operating system, see the documentation links provided in the table below.

Table 45. Resources to install the operating system

Resource	Documentation links
iDRAC	<p>Integrated Dell Remote Access Controller User's Guide or for system-specific Integrated Dell Remote Access Controller User's Guide, go to PowerEdge Manuals > Product Support page of your system > Documentation.</p>

Table 45. Resources to install the operating system (continued)

Resource	Documentation links
	<p>i NOTE: To determine the most recent iDRAC release for your platform and for the latest documentation version, see KB article at KB78115.</p>
Lifecycle Controller	<p>Dell Lifecycle Controller User's Guide at iDRAC Manuals or for system-specific Dell Lifecycle Controller User's Guide , go to PowerEdge Manuals > Product Support page of your system > Documentation. Dell Technologies recommends using Lifecycle Controller to install the OS, since all required drivers are installed on the system.</p> <p>i NOTE: To determine the most recent iDRAC release for your platform and for the latest documentation version, see KB article at KB78115.</p>

i **NOTE:** For more information about installation and how-to videos for operating systems that are supported on PowerEdge systems, see [Supported Operating Systems for Dell PowerEdge systems](#).

Options to download drivers and firmware

You can download the firmware from the Dell support site. For information about downloading firmware, see the [Downloading drivers and firmware](#) section.

You can also choose any one of the following options to download the firmware. For information about how to download the firmware, see the documentation links provided in the table below.

Table 46. Options to download firmware

Option	Documentation link
Using Integrated Dell Remote Access Controller Lifecycle Controller (iDRAC with LC)	idrac manuals
Using iDRAC virtual media	idrac manuals

Options to download and install OS drivers

You can choose any one of the following options to download and install OS drivers. For information about how to download or install OS drivers, see the documentation links provided in the table below.

Table 47. Options to download and install OS drivers

Option	Documentation
Dell support site	Downloading drivers and firmware section.
iDRAC virtual media	<p>Integrated Dell Remote Access Controller User's Guide or for system specific, go to Integrated Dell Remote Access Controller User's Guide > Product Support page of your system > Documentation .</p> <p>i NOTE: To determine the most recent iDRAC release for your platform and for latest documentation version, see iDRAC versions and release notes.</p>

Downloading drivers and firmware

It is recommended that you download and install the latest BIOS, drivers, and systems management firmware on the system.

Prerequisites

Ensure that you clear the web browser cache before downloading the drivers and firmware.

Steps

1. Go to [Drivers](#).
2. Enter the Service Tag of the system in the **Enter a Dell Service Tag, Dell Product ID or Model** field, and then press Enter.

 **NOTE:** If you do not have the Service Tag, click **Browse all products**, and navigate to your product.

3. On the displayed product page, click **Drivers & Downloads**.
On the **Drivers & Downloads** page, all drivers that are applicable to the system are displayed.
4. Download the drivers to a USB drive, CD, or DVD.

Pre-operating system management applications

You can manage basic settings and features of a system without booting to the operating system by using the system firmware.

Options to manage the pre-operating system applications

You can use any one of the following options to manage the pre-operating system applications:

- System Setup
- Boot Manager
- Preboot Execution Environment (PXE)

Topics:

- [System Setup](#)
- [Boot Manager](#)
- [PXE boot](#)

System Setup

Using the **System Setup** option, you can configure the BIOS settings, iDRAC settings, and device settings of the system.

You can access system setup by using any one of the following interfaces:

- Graphical User interface — To access go to iDRAC Dashboard, click **Configurations > BIOS Settings**.
- Text browser — To enable the text browser, use the Console Redirection.

To view

System Setup, power on the system, press F2, and click **System Setup Main Menu**.

NOTE: If the operating system begins to load before you press F2, wait for the system to finish booting, and then restart the system and try again.

The options on the

System Setup Main Menu screen are described in the following table:

Table 48. System Setup Main Menu

Option	Description
System BIOS	Enables you to configure the BIOS settings.
iDRAC Settings	Enables you to configure the iDRAC settings. The iDRAC utility is an interface to set up and configure the iDRAC parameters . You can enable or disable various iDRAC parameters by using the iDRAC utility. For more information about this utility, <i>Integrated Dell Remote Access Controller User's Guide</i> at PowerEdge Manuals .
Device Settings	Enables you to configure device settings for devices such as storage controllers or network cards.
Service Tag Settings	Enables you to configure the System Service Tag.

System BIOS

See the common options of the System BIOS here: [Support for General Solution Resources | Documentation | Dell US > Manuals and Documents > Set up BIOS on 17th Generation Dell PowerEdge Servers.](#)

iDRAC Settings

The iDRAC settings is an interface to set up and configure the iDRAC parameters by using UEFI. You can enable or disable various iDRAC parameters by using the iDRAC settings.

 **NOTE:** Accessing some of the features on the iDRAC settings needs the iDRAC Enterprise License upgrade.

For more information about using iDRAC, see *Dell Integrated Dell Remote Access Controller User's Guide* at [iDRAC Manuals](#).

Device Settings

Device Settings enables you to configure device parameters such as storage controllers or network cards.

Boot Manager

The **Boot Manager** option enables you to select boot options and diagnostic utilities.

To enter **Boot Manager**, power on the system and press F11.

Table 49. Boot Manager details

Option	Description
Continue Normal Boot	The system attempts to boot to devices starting with the first item in the boot order. If the boot attempt fails, the system continues with the next item in the boot order until the boot is successful or no more boot options are found.
One-shot UEFI Boot Menu	Enables you to access the boot menu, where you can select a one-time boot device to boot from.
Launch System Setup	Enables you to access System Setup.
System Utilities	Enables you to launch the System Utilities menu such as Launch Diagnostics, BIOS update File Explorer, Reboot System.

PXE boot

You can use the Preboot Execution Environment (PXE) option to boot and configure the networked systems remotely.

To access the **PXE boot** option, boot the system and then press F12 during POST instead of using standard Boot Sequence from BIOS Setup. It does not pull any menu or allows managing of network devices.

Minimum to POST and system management configuration validation

This section describes the minimum to POST system requirement and system management configuration validation of the Dell system.

Topics:

- [Minimum configuration to POST](#)

Minimum configuration to POST

The components listed below are the minimum configuration to POST:

- One processor
- One memory modules (DIMM) in slot A1
 1. Only 32 GB allowed for 1DIMM per one Intel® Xeon® 6 processor E- core processor, with limited features.
 2. Only 16 GB or 32 GB allowed for 1DIMM per one Intel® Xeon® 6 processor P- core processor, with limited features.
- One power supply unit
- Host Processor Module (HPM)
- Fan board
- Power Interposer board (PIB)
- DC-SCM
- Intrusion cable kit

 **NOTE:** The HPM was formerly called as system board.

Configuration validation

The new generation of Dell systems have added interconnect flexibility and advanced iDRAC management features to collect precise system configuration information and report configuration errors.

When the system is powered on, information about installed cables, risers, backplanes, power supplies, floating card (fPERC, adapter PERC, BOSS), and processor is obtained from the CPLD and backplane memory maps are analyzed. This information forms a unique configuration, which is compared with one of the qualified configurations that are stored in a table maintained by iDRAC.

One or more sensors are assigned to each of the configuration elements. During POST, any configuration validation error is logged in the System Event Log (SEL) log. The reported events are categorized in the configuration validation error table.

Table 50. Configuration validation error





Error	Description	Possible cause and recommendations	Example
Config Error	A configuration element within the closest match contains something that is unexpected and does not match any Dell qualified configuration.	Wrong configuration	Config Error: Backplane cable CTRS_SRC_SA1 and BP-DST_SA1
		The element reported in HWC8010 errors are assembled incorrectly. Verify element (cable, risers, etc) placement in the system.	Config Error : SL Cable PLANAR_SL2 and CTRL_DST_PA1
Config Missing	iDRAC found a configuration element missing within the closest match detected.	Missing or damaged cable, device, or part	Config Missing: Float card front PERC/HBA, adapter PERC/HBA
		Missing element or cable is reported in HWC8010 error logs. Install the missing element (cable, risers, etc).	Config Missing : SL cable PLANAR_SL8 and CTRL_DST_PA1
Comm Error	A configuration element is not responding to iDRAC using the management interface while running an inventory check.	System management sideband communication	Comm Error: Backplane 2
		Unplug AC Power, reseal the element and replace the element if the problem persists.	

Disassembly and reassembly

Topics:

- Safety instructions
- Before working inside your system
- After working inside your system
- Recommended tools
- Optional front bezel
- System cover
- Air shroud
- Cooling fans
- Drive backplane cover
- Drives
- Rear Drives
- Drive backplane
- Side wall brackets
- Cable routings
- System memory
- Processor and heat sink
- PERC cards
- Expansion cards and expansion card risers
- M.2 SSD module
- Optional M.2 Interposer board
- Optional BOSS-N1 DC-MHS module
- Optional OCP NIC card
- Datacenter-Secure Control Module (DC-SCM)
- Attic board
- Internal USB
- System battery
- Intrusion switch
- Power supply unit
- Trusted Platform Module
- HPM board
- Control panel

Safety instructions

-  **CAUTION:** Whenever you need to lift the system, get others to assist you. To avoid injury, do not attempt to lift the system by yourself.
-  **CAUTION:** Ensure that two or more people lift the system horizontally from the box and place it on a flat surface, rack lift, or into the rails.
-  **WARNING:** Opening or removing the system cover while the system is powered on may expose you to a risk of electric shock.
-  **WARNING:** Do not operate the system without the cover for a duration exceeding five minutes. Operating the system without the system cover can result in component damage.
-  **CAUTION:** Many repairs may only be done by a certified service technician. You should only perform troubleshooting and simple repairs as authorized in your product documentation, or as directed by the online or

telephone service and support team. Damage due to servicing that is not authorized by Dell is not covered by your warranty. Read and follow the safety instructions that are shipped with your product.

NOTE: It is recommended that you always use an antistatic mat and antistatic strap while working on components inside the system.

CAUTION: To ensure proper operation and cooling, all system bays and fans must always be populated with a component or a blank.

NOTE: Only use certified Optical Fiber Transceiver Class I Laser Products.

CAUTION: Do not install GPUs, network cards, or other PCIe devices on your system that are not validated and tested by Dell. Damage caused by unauthorized and invalidated hardware installation will null and void the system warranty.

Before working inside your system

Prerequisites

Follow the safety guidelines listed in the [Safety instructions](#).

Steps

1. Power off the system and all attached peripherals.
2. Disconnect the system from the electrical outlet and disconnect the peripherals.
3. If applicable, remove the system from the rack.

For more information, see the *Rail Installation Guide* relevant to your rail solutions at [PowerEdge manuals](#).

4. Remove the system cover.

NOTE: While removing the hot-swappable components from the front or rear of the system, do not remove the system cover.

After working inside your system

Prerequisites

Follow the safety guidelines listed in [Safety instructions](#).

Steps

1. Replace the system covers.
2. If applicable, install the system into the rack.
For more information, see the *Rail Installation Guide* relevant to your system at [PowerEdge manuals](#).
3. Reconnect the peripherals and connect the to the electrical outlet, and then power on the system.

Recommended tools

You may need some or all of the following tools to perform the removal and installation procedures:

- Key to the bezel lock. The key is required only if your system includes a bezel.
- Phillips 1 screwdriver
- Phillips 2 screwdriver
- Torx T6 screwdriver
- Torx T30 screwdriver
- Plastic scribe
- 1/4-inch flat blade screwdriver

- Wrist grounding strap connected to the ground
- ESD mat
- Needle-nose pliers

Optional front bezel

Removing the front bezel

Prerequisites

1. Follow the safety guidelines listed in the [Safety instructions](#).
2. Keep the bezel key handy.

NOTE: The bezel key is part of the bezel package.

Steps

1. Rotate the key clockwise to unlock the bezel.
2. Press the release button, and disengage the left end of the bezel.
3. Unhook the right end, and remove the bezel.

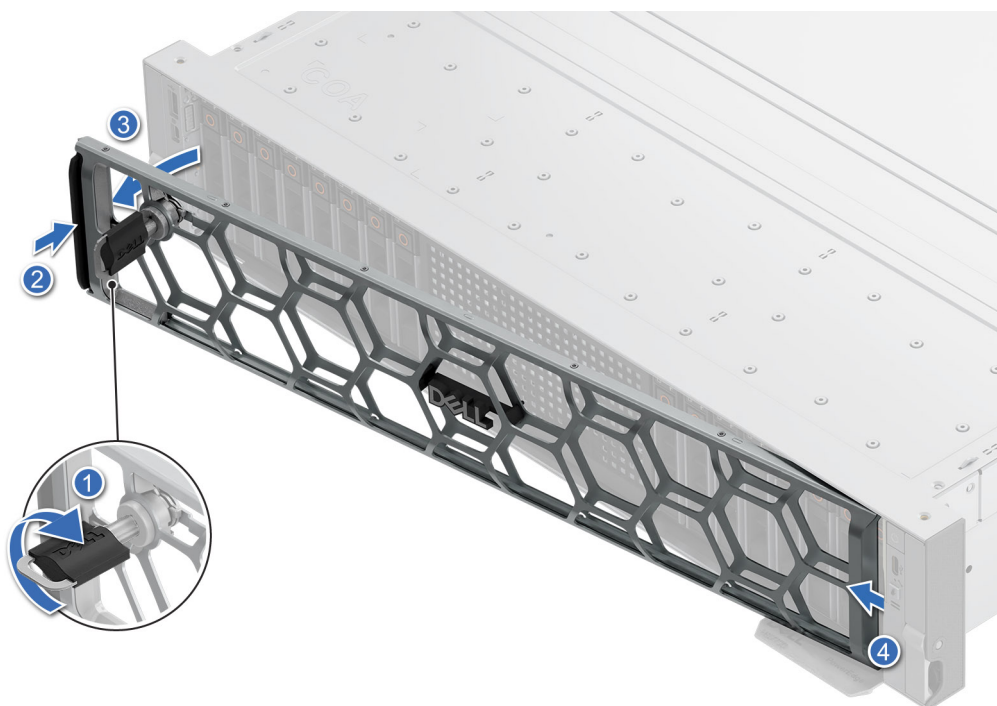

Figure 32. Removing the front bezel

NOTE: The front bezel is not available on a front I/O configuration system.

Next steps

[Replace front bezel.](#)

Installing the front bezel

Prerequisites

1. Follow the safety guidelines listed in the [Safety instructions](#).
2. Locate and remove the bezel key.

NOTE: The bezel key is part of the bezel package.

Steps

1. Align and insert the tabs on the bezel into the slots on the system.
2. Press the bezel until the release button clicks in place.
3. Rotate the key anti-clockwise to lock the bezel.

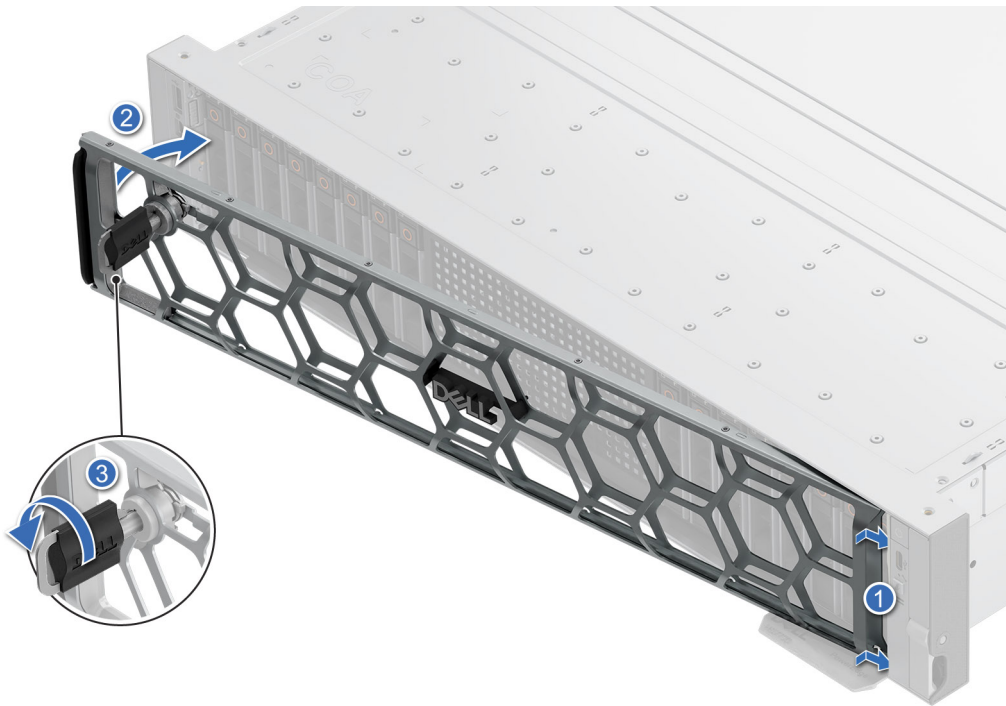

Figure 33. Installing the front bezel

System cover

Removing the system cover

Prerequisites

1. Follow the safety guidelines listed in the [Safety instructions](#).
2. Power off the system, and any attached peripherals.
3. Disconnect the system from the electrical outlet and peripherals.

Steps

1. Using a 1/4-inch flat head or a Phillips 2 screwdriver, rotate the lock counterclockwise to the unlock position.
2. Lift the release latch until the system cover slides back.
3. Lift the cover from the system.



Figure 34. Removing the system cover

Next steps

Replace the system cover.

Installing the system cover

Prerequisites

1. Follow the safety guidelines listed in the [Safety instructions](#).
2. Follow the procedure listed in [Before working inside your system](#).
3. Ensure that all internal cables are connected and routed properly, and no tools or extra parts are left inside the system.

Steps

1. Align the tabs on the system cover with the guide slots on the system and slide the system cover.
2. Close the system cover release latch.
3. Using a 1/4-inch flat head or Phillips 2 screwdriver, rotate the lock clockwise to the lock position.



Figure 35. Installing the system cover

Next steps

Follow the procedure listed in [After working inside your system](#).

Air shroud

Removing the air shroud

Prerequisites

1. Follow the safety guidelines listed in the [Safety instructions](#).
2. Follow the procedure listed in [Before working inside your system](#).
3. [Remove the system cover](#)

Steps

Holding the sides lift the air shroud out of the system.

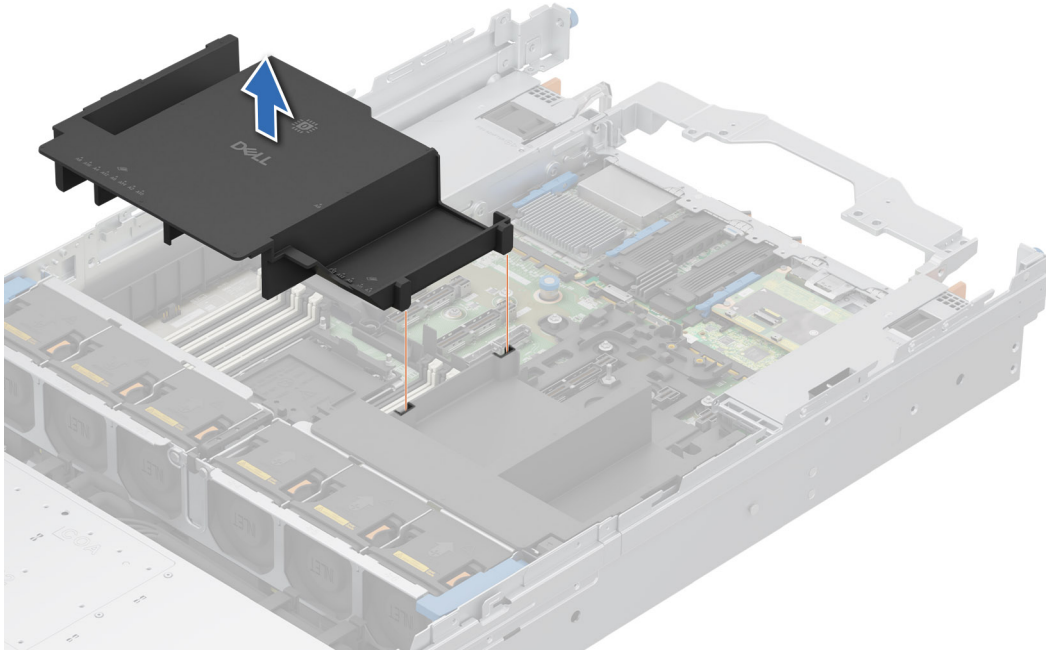

Figure 36. Removing the left air shroud

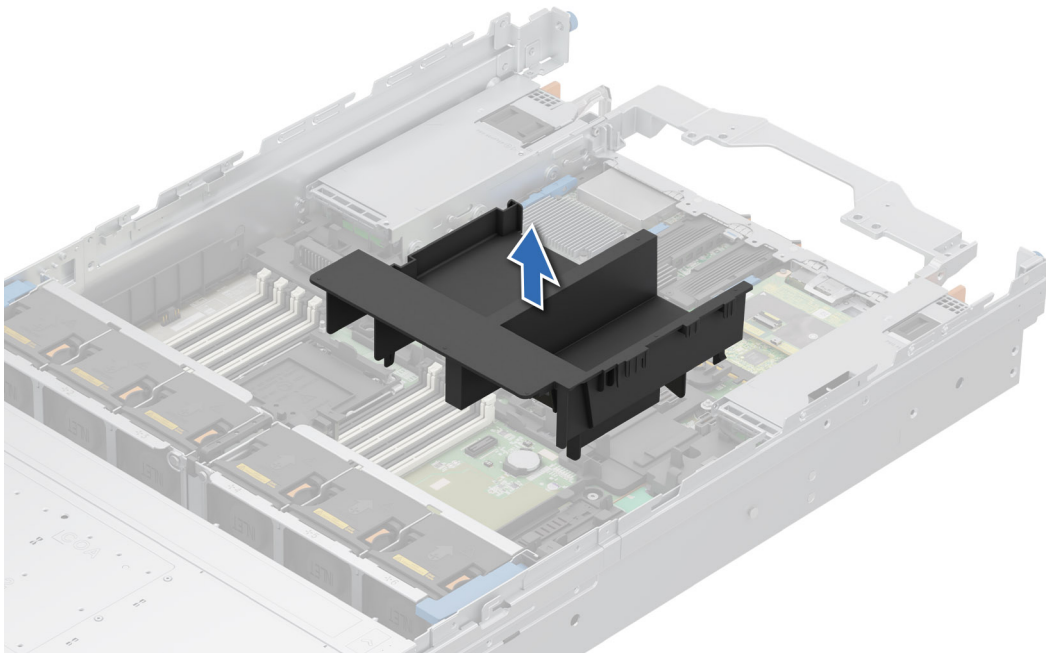

Figure 37. Removing the right air shroud

Next steps

Replace the air shroud.

Installing the air shroud

Prerequisites

1. Follow the safety guidelines listed in the [Safety instructions](#).

2. Follow the procedure listed in [Before working inside your system](#).

Steps

Align and lower the air shroud till it is firmly seated in the system .

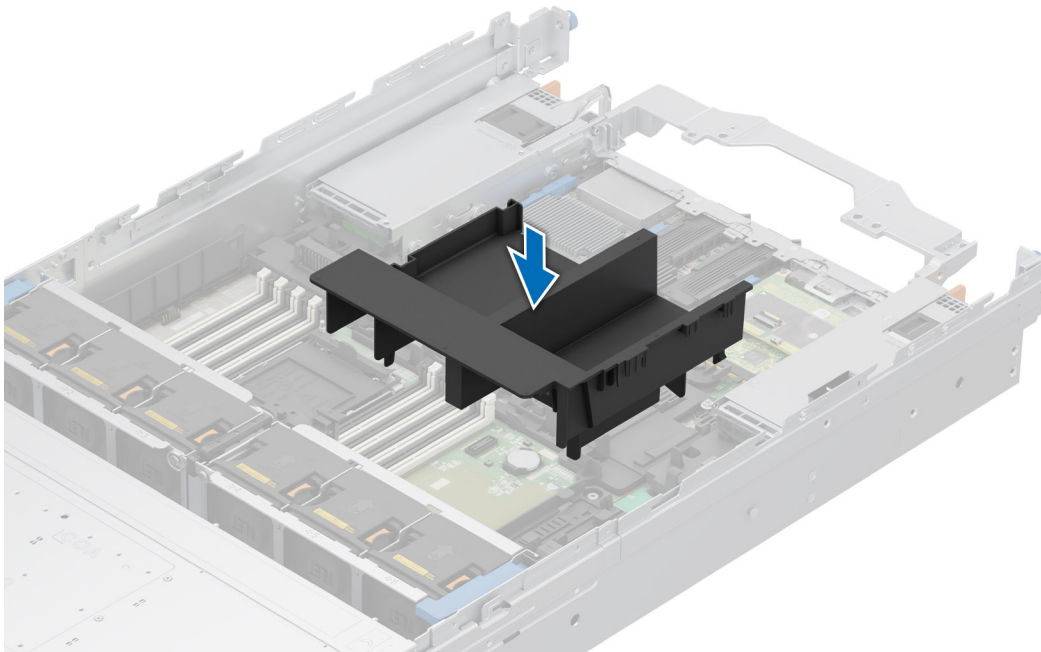

Figure 38. Installing the right air shroud

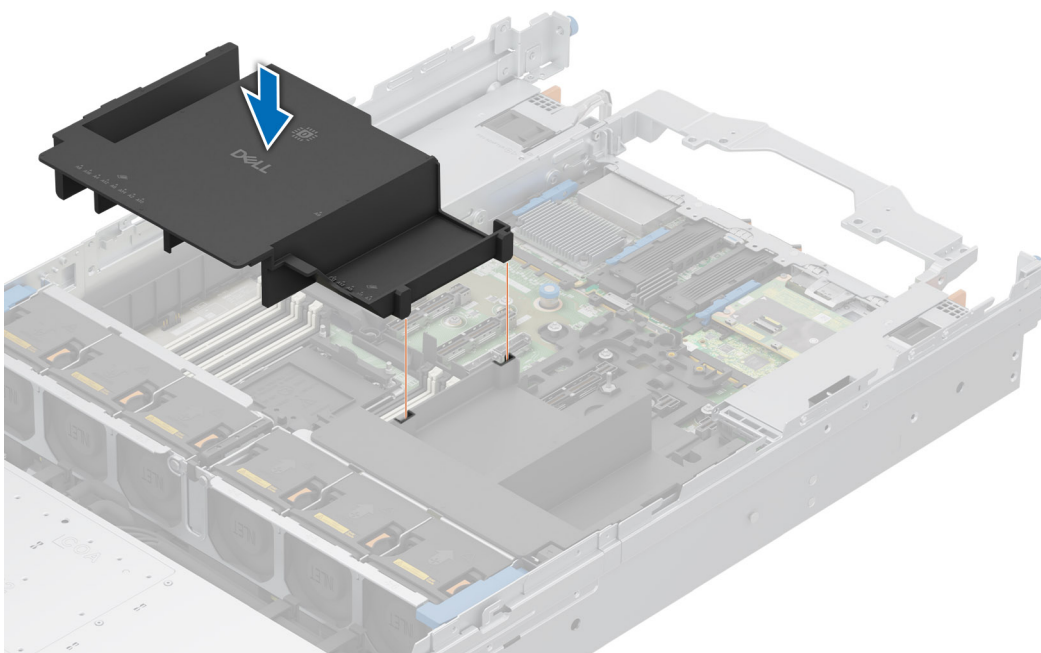

Figure 39. Installing the left air shroud

Next steps

Follow the procedure listed in [After working inside your system](#).

Cooling fans

Removing a cooling fan

Prerequisites

1. Follow the safety guidelines listed in the [Safety instructions](#).
2. Follow the procedure listed in [Before working inside your system](#).
3. [Remove the system cover](#)

Steps

Holding the orange and black edges on the fan module, lift the cooling fan module to disconnect from the connector on the fan board.

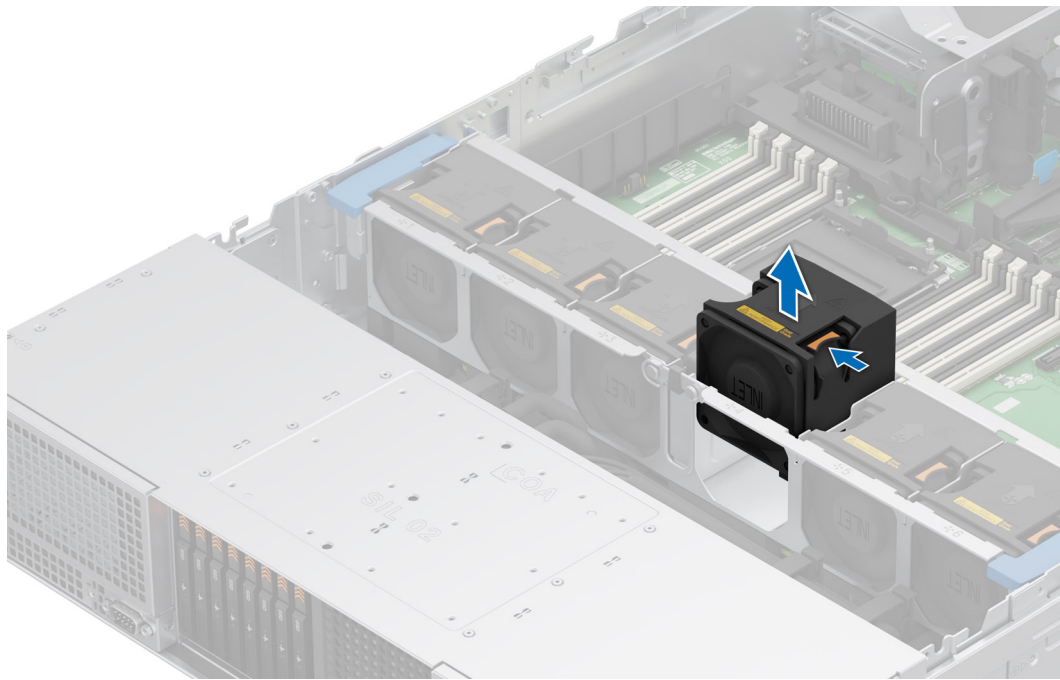

Figure 40. Removing a cooling fan

Next steps

[Replace a cooling fan.](#)

Installing a cooling fan

Prerequisites

1. Follow the safety guidelines listed in the [Safety instructions](#).
2. Follow the procedure listed in [Before working inside your system](#).

Steps

1. Align and lower the cooling fan onto the connector on the fan board.
2. Press the orange touch point on the cooling fan module until it is firmly connected.

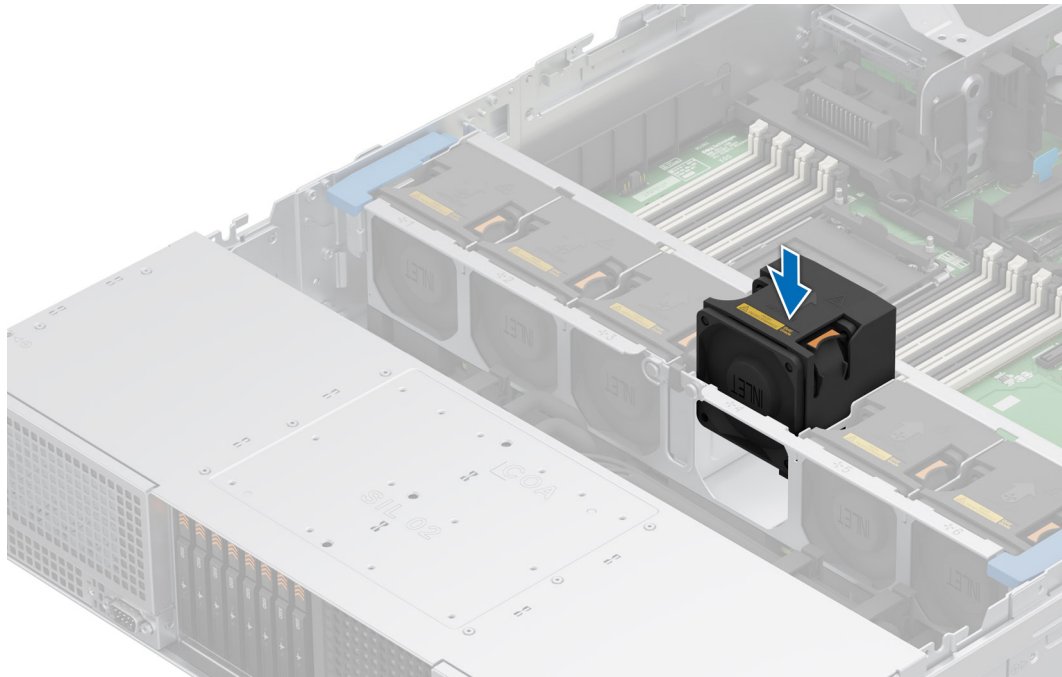

Figure 41. Installing a cooling fan

Next steps

Follow the procedure listed in [After working inside your system](#).

Removing the cooling fan cage assembly

Prerequisites

1. Follow the safety guidelines listed in the [Safety instructions](#).
2. Follow the procedure listed in the [Before working inside your system](#).
3. If required, remove the cables that pass through the cooling fan cage assembly.
4. If required, [remove the air shroud](#).

Steps

1. Lift the blue release levers to unlock the cooling fan cage assembly from the system.
2. Hold the release levers, and lift the cooling fan cage assembly away from the system.

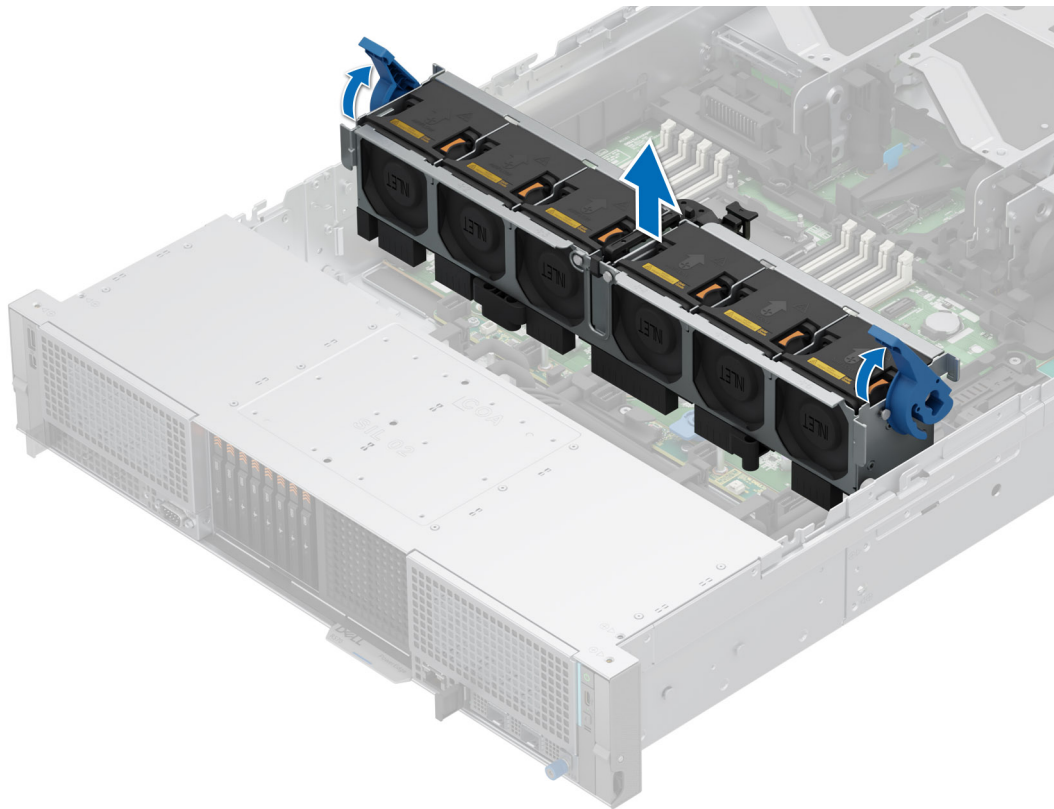

Figure 42. Removing the cooling fan cage assembly

Next steps

1. [Replace the cooling fan cage assembly.](#)

Installing the cooling fan cage assembly

Prerequisites

1. Follow the safety guidelines listed in the [Safety instructions](#).

CAUTION: Before installing the cooling fan cage assembly, ensure that the cables inside the system are properly installed and retained by the cable retention brackets. Cables that are not properly installed may be damaged.

2. Follow the procedure listed in [Before working inside your system](#).
3. If required, remove the cables that pass through the cooling fan cage assembly.
4. If installed, [remove the air shroud](#).

Steps

1. Holding the blue release lever of the cooling fan cage, align the guide rails with the guides on the system.
2. Lower the cooling fan cage assembly into the system until seated firmly.
3. Lower the blue release lever and press to lock the cooling fan cage assembly into the system.

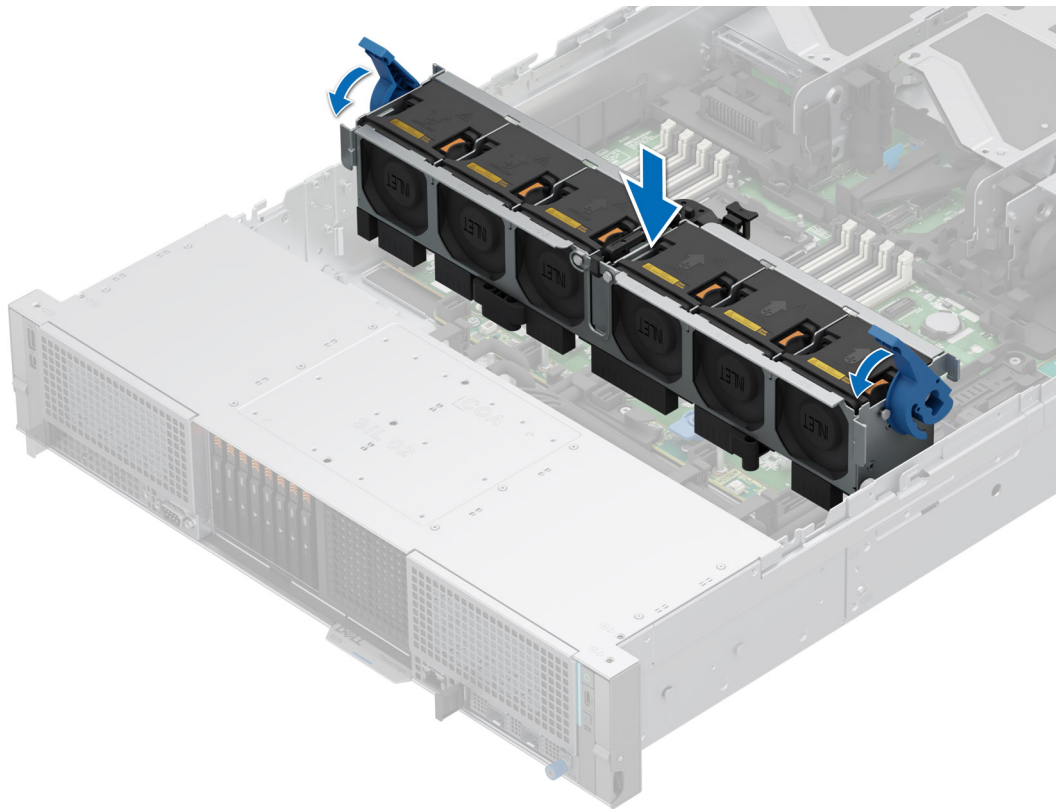

Figure 43. Installing the cooling fan cage assembly

Next steps

1. If removed, [install the air shroud](#).
2. Follow the procedure listed in [After working inside your system](#).

Removing the rear E3.S module cooling fan

Prerequisites

1. Follow the safety guidelines listed in the [Safety instructions](#).
2. Follow the procedure listed in the [Before working inside your system](#).
3. [Remove the system cover](#).
4. [Remove the air shroud](#).

Steps

1. Disconnect the fan power cable from the rear E3.S module.
2. Holding the blue and black edges on the fan module, lift the cooling fan module to remove it from the rear E3.S module.

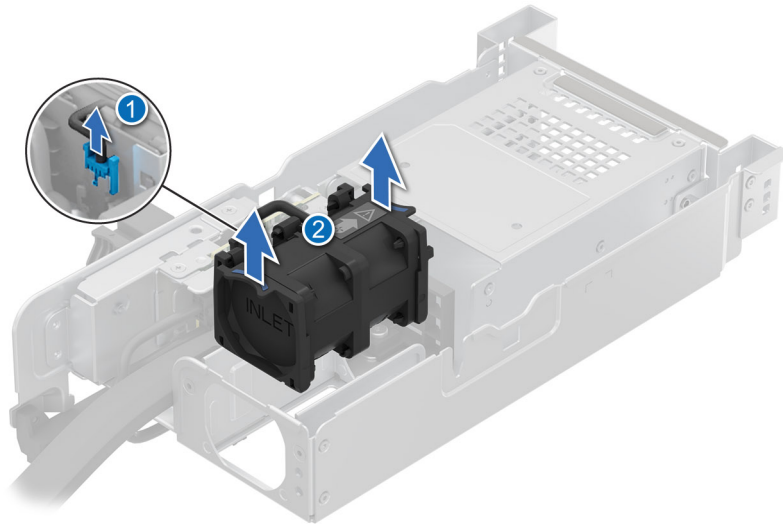

Figure 44. Removing the rear E3.S module cooling fan

Next steps

Replace the rear E3.S module cooling fan.

Installing the rear E3.S module cooling fan

Prerequisites

1. Follow the safety guidelines listed in the [Safety instructions](#).
2. Follow the procedure listed in the [Before working inside your system](#).
3. [Remove the system cover](#).
4. [Remove the air shroud](#).

Steps

1. Align and lower the cooling fan into the rear E3.S module.
2. Press the blue touch point on the cooling fan module until it is firmly connected.
3. Connect the fan power cable to the rear E3.S module.

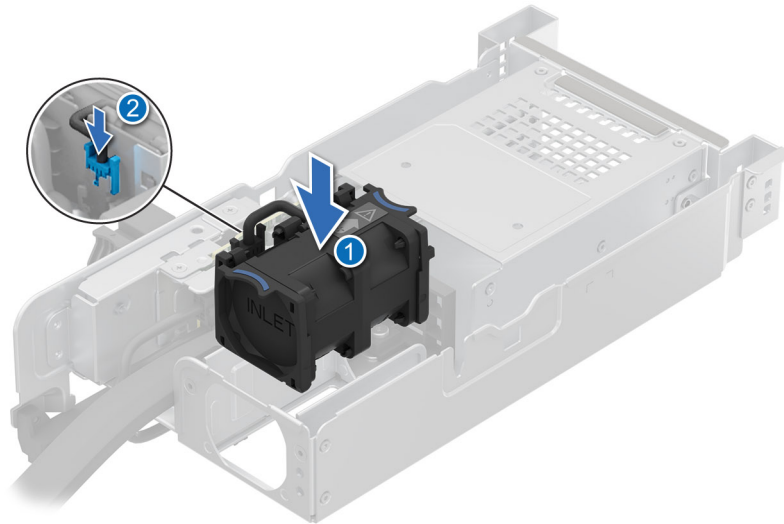

Figure 45. Installing the rear E3.S module cooling fan

Next steps

1. [Install the air shroud.](#)
2. [Install the system cover.](#)
3. Follow the procedure listed in [After working inside your system.](#)

Drive backplane cover

Removing the drive backplane cover

Prerequisites

1. Follow the safety guidelines listed in the [Safety instructions.](#)
2. Follow the procedure listed in [Before working inside your system.](#)
3. [Remove the system cover.](#)

Steps

1. Slide the drive backplane cover in the direction of the arrows marked on the drive backplane cover.
2. Lift the drive backplane cover from the system.

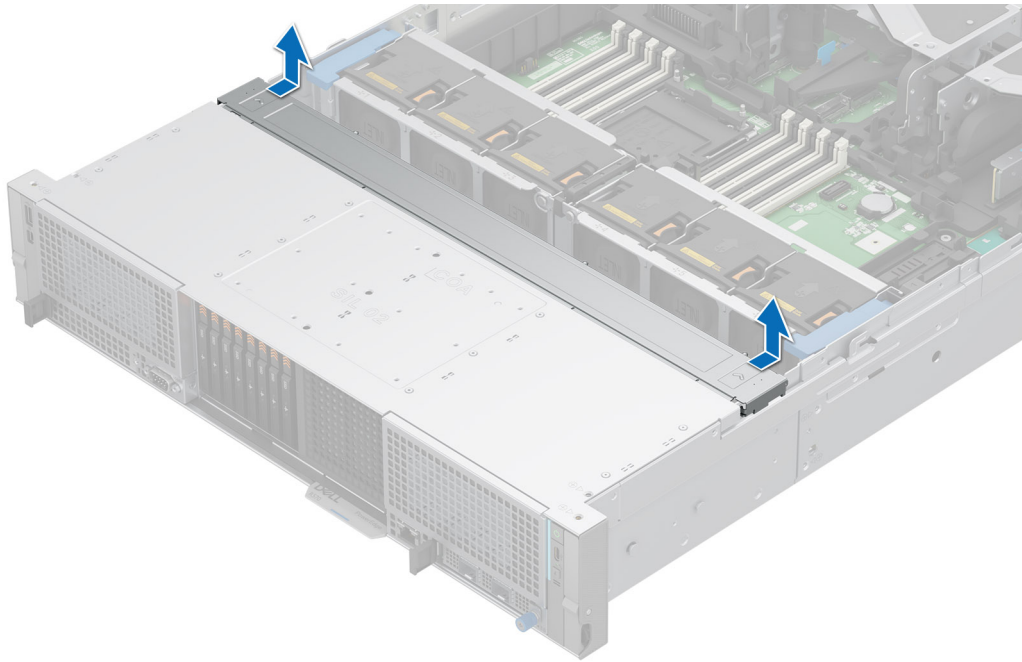

Figure 46. Removing the drive backplane cover

Next steps

1. [Replace the drive backplane cover.](#)

Installing the drive backplane cover

Prerequisites

1. Follow the safety guidelines listed in the [Safety instructions](#).
2. Follow the procedure listed in [Before working inside your system](#).
3. [Remove the system cover.](#)

Steps

1. Align the drive backplane cover with the guide slots on the system.
2. Slide the drive backplane cover to the front of the system until the drive backplane cover fits into place.

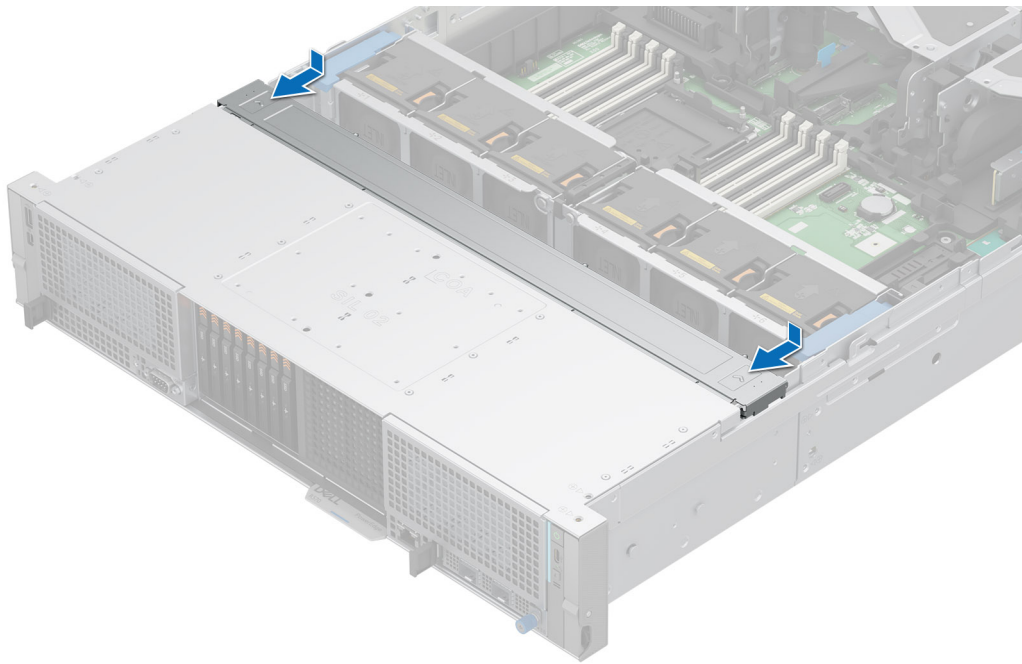

Figure 47. Installing the drive backplane cover

Next steps

1. Follow the procedure listed in [After working inside your system](#).
2. [Replace the system cover](#).

Drives

Removing an EDSFF E3.S drive blank

Prerequisites

1. Follow the safety guidelines listed in the [Safety instructions](#).
2. If installed, [remove the front bezel](#).

CAUTION: To maintain proper system cooling, drive blanks must be installed in all empty drive slots.

Steps

Lift the release button, and slide the drive blank out of the drive slot.



Figure 48. Removing an EDSFF E3.S drive blank

Next steps

1. [Replace the EDSFF E3.S drive blank.](#)

Installing an EDSFF E3.S drive blank

Prerequisites

1. Follow the safety guidelines listed in the [Safety instructions](#).
2. If installed, [remove the front bezel](#).

Steps

Slide the drive blank into the drive slot until the release button clicks into place.



Figure 49. Installing an EDSFF E3.S drive blank

Next steps

1. If removed, [install the front bezel](#).

Removing an EDSFF E3.S drive carrier

Prerequisites

1. Follow the safety guidelines listed in [Safety instructions](#).
2. [remove the front bezel](#).
3. Using the management software, prepare the drive for removal. If the drive is online, the green activity or fault indicator flashes while the drive is turning off. When the drive indicators are off, the drive is ready for removal. For more information, see the storage controller documentation.

CAUTION: Before attempting to remove or install a drive while the system is running, see the documentation for the storage controller card to ensure that the host adapter is configured correctly to support drive removal and insertion.

CAUTION: To prevent data loss, ensure that your operating system supports drive installation. See the documentation supplied with your operating system.

Steps

1. Lift the release button to open the drive carrier release handle.
2. Holding the drive carrier release handle, slide the drive carrier out of the drive slot.

NOTE: If you are not replacing the drive immediately, install an EDSFF E3.S drive blank in the empty drive slot to maintain proper system cooling.

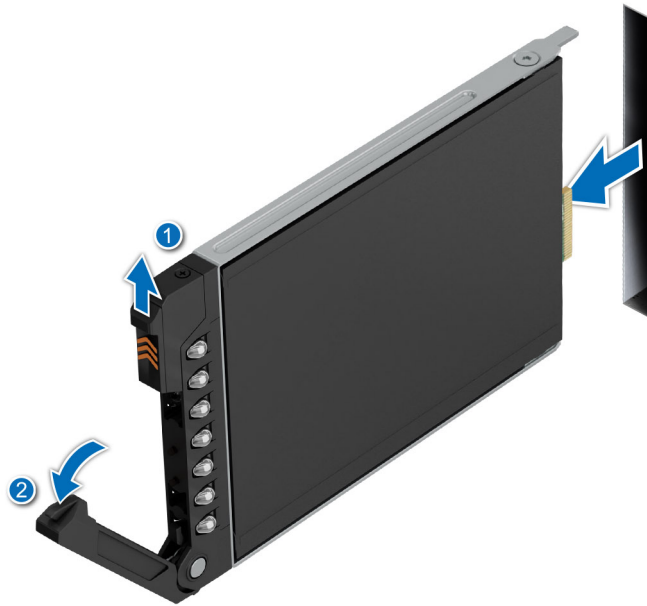

Figure 50. Removing an EDSFF E3.S drive carrier

Next steps

Replace the EDSFF E3.S drive or install the EDSFF E3.S drive blank.

Removing an EDSFF E3.S drive from the drive carrier

Prerequisites

1. Follow the safety guidelines listed in the [Safety instructions](#).
2. [Remove an EDSFF E3.S drive carrier](#).

Steps

1. Using a Torx 6 screwdriver, remove the screws from the slide rails on the drive carrier.



2. Lift the drive out of the drive carrier.

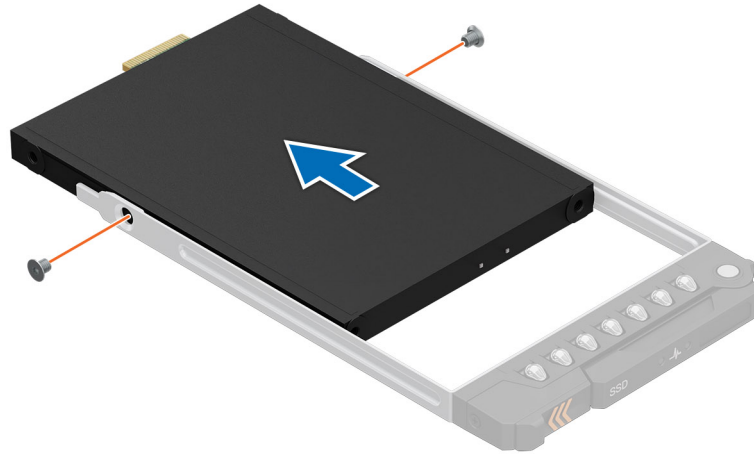

Figure 51. Removing an EDSFF E3.S drive from the drive carrier

Next steps

Install an EDSFF E3.S drive into the drive carrier.

Installing an EDSFF E3.S drive into the drive carrier

Prerequisites

1. Follow the safety guidelines listed in the [Safety instructions](#).
2. [Remove an EDSFF E3.S drive carrier](#).

Steps

1. Insert the drive into the drive carrier with the drive connector facing towards the rear of the carrier.
2. Align the screw holes on the drive with the screw holes on the drive carrier.
3. Using a Torx 6 screwdriver, secure the drive to the drive carrier with the screws.

 **NOTE:** When installing a drive into the drive carrier, ensure that the screws are torqued to 4 in-lbf.



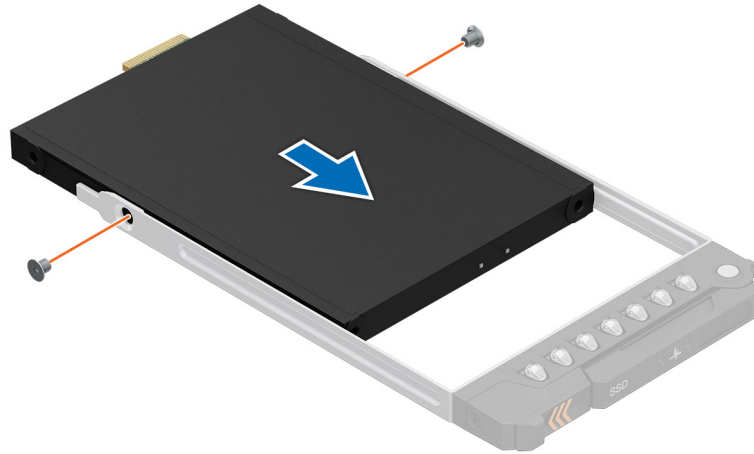

Figure 52. Installing an EDSFF E3.S drive into the drive carrier

Next steps

1. [Install the drive carrier.](#)

Installing an EDSFF E3.S drive carrier

Prerequisites

- ⚠ **CAUTION:** Before removing or installing a drive while the system is running, see the [Storage Controller Manuals](#) documentation for the storage controller card to ensure that the host adapter is configured correctly to support drive removal and insertion.
- ⚠ **CAUTION:** Combining SAS and SATA drives in the same RAID volume is not supported.
- ⚠ **CAUTION:** When installing a drive, ensure that the adjacent drives are fully installed. Inserting a drive carrier and attempting to lock its handle next to a partially installed carrier can damage the partially installed carrier's shield spring and make it unusable.
- ℹ **NOTE:** Ensure that the drive carrier's release handle is in the open position before inserting the carrier into the slot.
- ⚠ **CAUTION:** To prevent data loss, ensure that your operating system supports hot-swap drive installation. See the documentation supplied with your operating system.
- ⚠ **CAUTION:** When a replacement hot swappable drive is installed and the system is powered on, the drive automatically begins to rebuild. Ensure that the replacement drive is blank or contains data that you wish to overwrite. Any data on the replacement drive is immediately lost after the drive is installed.

1. Follow the safety guidelines listed in [Safety instructions](#).
2. [remove the front bezel](#).
3. Remove the drive carrier or remove the drive blank when you want to assemble the drive into the system.

Steps

1. Slide the drive carrier into the drive slot and push until the drive connects with the backplane.
2. Close the drive carrier release handle to lock the drive in place.

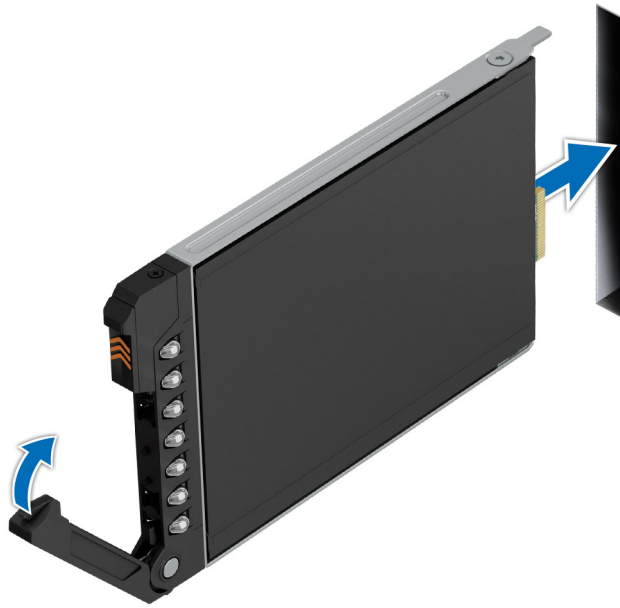

Figure 53. Installing an EDSFF E3.S drive carrier

Next steps

Install the front bezel.

Removing a 2.5-inch drive blank

Prerequisites

1. Follow the safety guidelines listed in the [Safety instructions](#).
2. If installed, [remove the front bezel](#).

CAUTION: To maintain proper system cooling, drive blanks must be installed in all empty drive slots.

Steps

Press the release button, and slide the drive blank out of the drive slot.

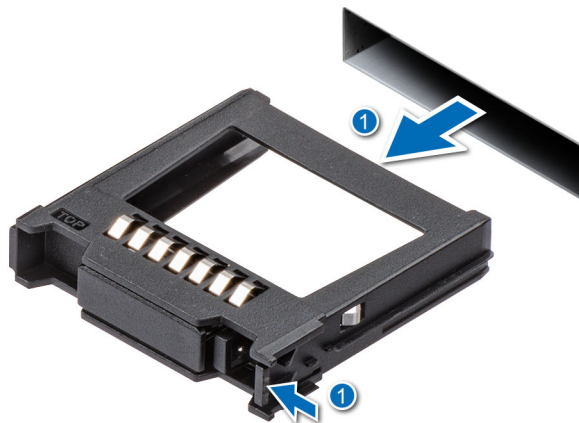

Figure 54. Removing a 2.5-inch drive blank

Next steps

1. [Replace the 2.5-inch drive blank](#).

Installing a 2.5-inch drive blank

Prerequisites

1. Follow the safety guidelines listed in the [Safety instructions](#).
2. If installed, [remove the front bezel](#).

Steps

Insert the drive blank into the drive slot, and push the blank until the release button clicks into place.

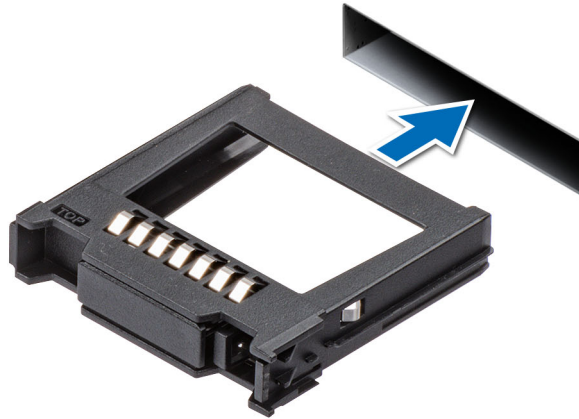

Figure 55. Installing a 2.5-inch drive blank

Next steps

1. If removed, [install the front bezel](#).

Removing a 2.5-inch drive carrier

Prerequisites

1. Follow the safety guidelines listed in [Safety instructions](#).
2. [remove the front bezel](#).
3. Using the management software, prepare the drive for removal. If the drive is online, the green activity or fault indicator flashes while the drive is turning off. When the drive indicators are off, the drive is ready for removal. For more information, see the storage controller documentation.

CAUTION: Before attempting to remove or install a drive while the system is running, see the documentation for the storage controller card to ensure that the host adapter is configured correctly to support drive removal and insertion.

CAUTION: To prevent data loss, ensure that your operating system supports drive installation. See the documentation supplied with your operating system.

Steps

1. Press the release button to open the drive carrier release handle.
2. Holding the handle, slide the drive carrier out of the drive slot.

NOTE: The numbers on the image do not depict the exact steps. The numbers are for representation of sequence.



Figure 56. Removing a 2.5-inch drive carrier

Next steps

Replace the 2.5-inch drive or install the 2.5-inch drive blank.

Removing a 2.5-inch drive from the drive carrier

Prerequisites

1. Follow the safety guidelines listed in the [Safety instructions](#).
2. [Remove the drive carrier](#).

Steps

1. Using a Phillips #1 screwdriver, remove the screws from the slide rails on the drive carrier.

NOTE: If the hard drive or SSD carrier has a Torx screw, use Torx 6 (for 2.5-inch drive) screwdriver to remove the drive.

2. Lift the drive out of the drive carrier.

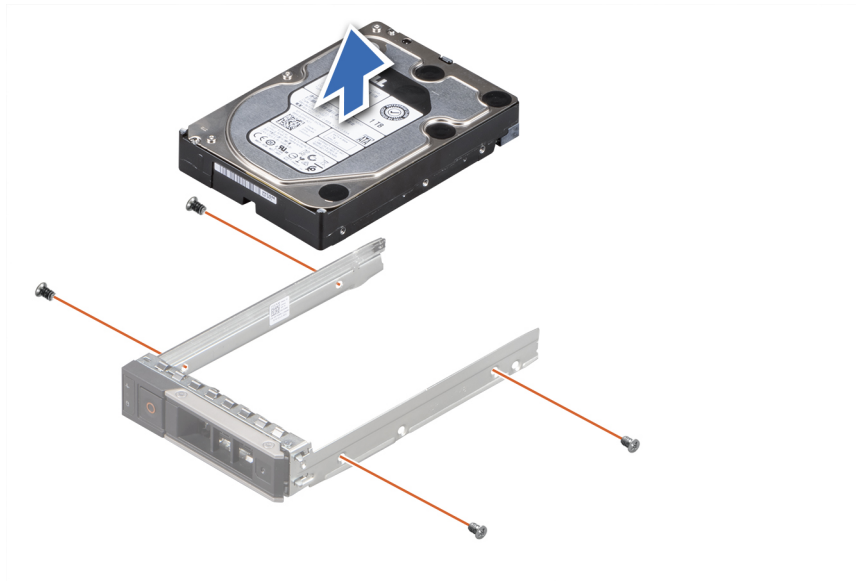

Figure 57. Removing the 2.5-inch drive from the drive carrier

Next steps

Install a 2.5-inch drive into the drive carrier.



Installing a 2.5-inch drive into the drive carrier

Prerequisites

1. Follow the safety guidelines listed in the [Safety instructions](#).
2. [Remove the drive carrier](#).

Steps

1. Insert the drive into the drive carrier with the connector end of the drive towards the back of the carrier.
2. Align the screw holes on the drive with the screw holes on the drive carrier.
3. Using a Phillips #1 screwdriver, replace the screws to secure the drive to the drive carrier.

 **NOTE:** If the hard drive or SSD carrier has a Torx screw, use Torx 6 (for 2.5-inch drive) screwdriver to install the drive. 

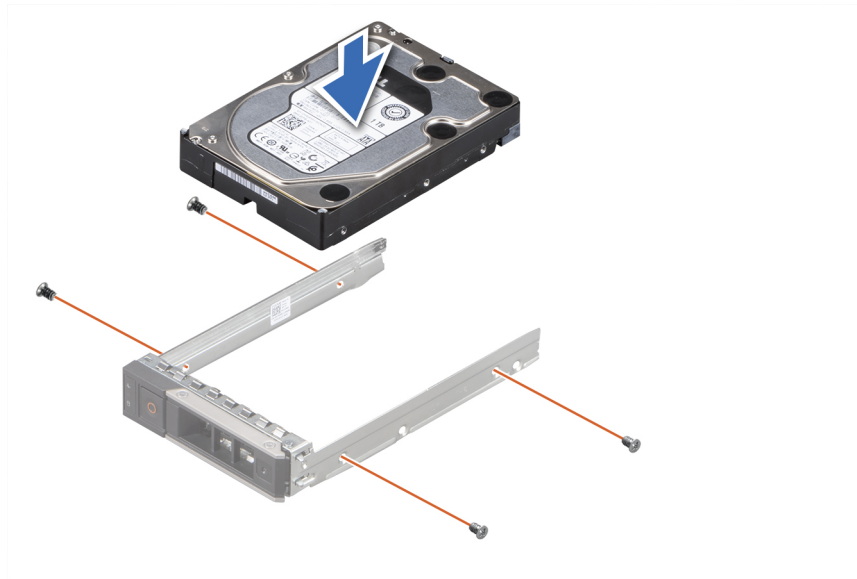

Figure 58. Installing a drive into the drive carrier

Next steps

1. [Install the drive carrier.](#)

Installing a 2.5-inch drive carrier

Prerequisites

CAUTION: Before removing or installing a drive while the system is running, see the [Storage Controller Manuals](#) documentation for the storage controller card to ensure that the host adapter is configured correctly to support drive removal and insertion.

CAUTION: Combining SAS and SATA drives in the same RAID volume is not supported.

CAUTION: When installing a drive, ensure that the adjacent drives are fully installed. Inserting a drive carrier and attempting to lock its handle next to a partially installed carrier can damage the partially installed carrier's shield spring and make it unusable.

NOTE: Ensure that the drive carrier's release handle is in the open position before inserting the carrier into the slot.

CAUTION: To prevent data loss, ensure that your operating system supports hot-swap drive installation. See the documentation supplied with your operating system.

CAUTION: When a replacement hot swappable drive is installed and the system is powered on, the drive automatically begins to rebuild. Ensure that the replacement drive is blank or contains data that you wish to overwrite. Any data on the replacement drive is immediately lost after the drive is installed.

1. Follow the safety guidelines listed in [Safety instructions](#).
2. [remove the front bezel.](#)
3. Remove the drive carrier or remove the drive blank when you want to assemble the drive into the system.

Steps

1. Press the release button on the front of the drive carrier to open the release handle.
2. Insert and slide the drive carrier into the drive slot.
3. Close the drive carrier release handle until it clicks in place.

NOTE: The numbers on the image do not depict the exact steps. The numbers are for representation of sequence.

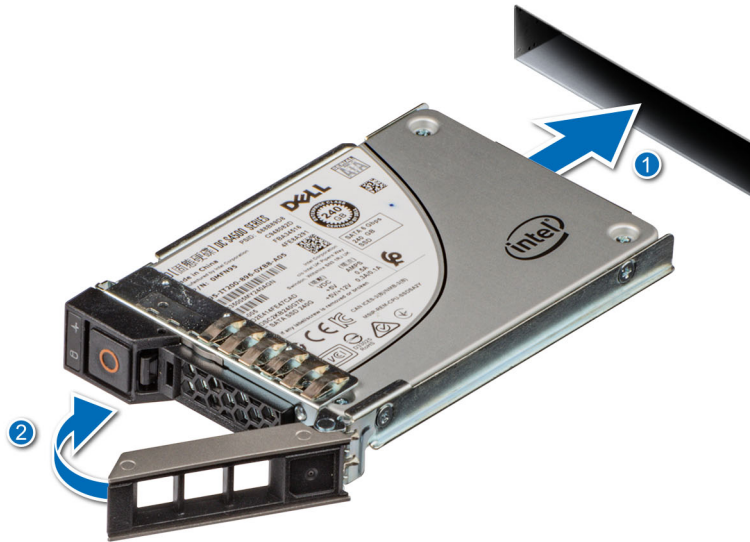

Figure 59. Installing a 2.5-inch drive carrier

Next steps

install the front bezel.

Removing a 3.5-inch drive blank

Prerequisites

1. Follow the safety guidelines listed in the [Safety instructions](#).
2. If installed, [remove the front bezel](#).

CAUTION: To maintain proper system cooling, drive blanks must be installed in all empty drive slots.

Steps

Press the release button, and slide the drive blank out of the drive slot.

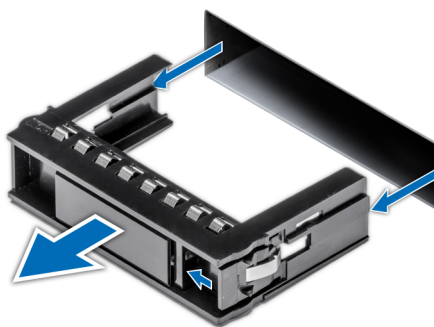

Figure 60. Removing a 3.5-inch drive blank

Next steps

1. [Replace the 3.5-inch drive blank](#).

Installing a 3.5-inch drive blank

Prerequisites

1. Follow the safety guidelines listed in the [Safety instructions](#).
2. If installed, [remove the front bezel](#).

Steps

Insert the drive blank into the drive slot, and push the blank until the release button clicks into place.

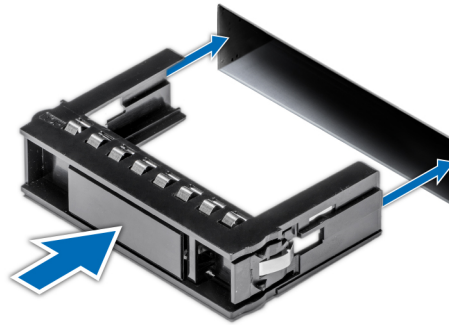

Figure 61. Installing a 3.5-inch drive blank

Next steps

1. If removed, [install the front bezel](#).

Removing a 3.5-inch drive carrier

Prerequisites

1. Follow the safety guidelines listed in [Safety instructions](#).
2. [remove the front bezel](#).
3. Using the management software, prepare the drive for removal. If the drive is online, the green activity or fault indicator flashes while the drive is turning off. When the drive indicators are off, the drive is ready for removal. For more information, see the storage controller documentation.

CAUTION: Before attempting to remove or install a drive while the system is running, see the documentation for the storage controller card to ensure that the host adapter is configured correctly to support drive removal and insertion.

CAUTION: To prevent data loss, ensure that your operating system supports drive installation. See the documentation supplied with your operating system.

Steps

1. Press the release button to open the drive carrier release handle.
2. Holding the handle, slide the drive carrier out of the drive slot.

NOTE: The numbers on the image do not depict the exact steps. The numbers are for representation of sequence.



Figure 62. Removing a 3.5-inch drive carrier

Next steps

Replace the 3.5-inch drive or install the 3.5-inch drive blank.

Removing a 3.5-inch drive from the drive carrier

Prerequisites

1. Follow the safety guidelines listed in the [Safety instructions](#).
2. [Remove the drive carrier](#).

Steps

1. Using a Phillips #1 screwdriver, remove the screws from the slide rails on the drive carrier.

NOTE: If the hard drive or SSD carrier has a Torx screw, use Torx 6 (for 3.5-inch drive) screwdriver to remove the drive.

2. Lift the drive out of the drive carrier.



Figure 63. Removing the 3.5-inch drive from the drive carrier

Next steps

Install a 3.5-inch drive into the drive carrier.

Installing a 3.5-inch drive into the drive carrier

Prerequisites

1. Follow the safety guidelines listed in the [Safety instructions](#).
2. [Remove the drive carrier](#).

Steps

1. Insert the drive into the drive carrier with the connector end of the drive towards the back of the carrier.
2. Align the screw holes on the drive with the screw holes on the drive carrier.
3. Using a Phillips #1 screwdriver, replace the screws to secure the drive to the drive carrier.

NOTE: If the hard drive or SSD carrier has a Torx screw, use Torx 6 (for 3.5-inch drive) screwdriver to install the drive.



Figure 64. Installing a drive into the drive carrier

Next steps

1. [Install the drive carrier.](#)

Installing a 3.5-inch drive carrier

Prerequisites

CAUTION: Before removing or installing a drive while the system is running, see the [Storage Controller Manuals](#) documentation for the storage controller card to ensure that the host adapter is configured correctly to support drive removal and insertion.

CAUTION: Combining SAS and SATA drives in the same RAID volume is not supported.

CAUTION: When installing a drive, ensure that the adjacent drives are fully installed. Inserting a drive carrier and attempting to lock its handle next to a partially installed carrier can damage the partially installed carrier's shield spring and make it unusable.

NOTE: Ensure that the drive carrier's release handle is in the open position before inserting the carrier into the slot.

CAUTION: To prevent data loss, ensure that your operating system supports hot-swap drive installation. See the documentation supplied with your operating system.

CAUTION: When a replacement hot swappable drive is installed and the system is powered on, the drive automatically begins to rebuild. Ensure that the replacement drive is blank or contains data that you wish to overwrite. Any data on the replacement drive is immediately lost after the drive is installed.

1. Follow the safety guidelines listed in [Safety instructions](#).
2. [remove the front bezel.](#)
3. Remove the drive carrier or remove the drive blank when you want to assemble the drive into the system.

Steps

1. Press the release button on the front of the drive carrier to open the release handle.
2. Insert and slide the drive carrier into the drive slot.
3. Close the drive carrier release handle until it clicks in place.

NOTE: The numbers on the image do not depict the exact steps. The numbers are for representation of sequence.



Figure 65. Installing a 3.5-inch drive carrier

Next steps

install the front bezel.

Rear Drives

Removing the rear 4 x EDSFF E3.S module

Prerequisites

1. Follow the safety guidelines listed in the [Safety instructions](#).
2. Follow the procedure listed in the [Before working inside your system](#).
3. [Remove the system cover](#).
4. [Remove the air shroud](#).
5. [Remove the rear EDSFF E3.S drives](#).
6. Disconnect the power cable and other required cables, observe the cable routing.

i **NOTE:** See [cable routing](#) section.

Steps

1. Using a Phillips #2 screwdriver, loosen the captive screws that secure the rear drive module to the system.
2. Press the blue release tab and holding the edges lift the rear drive module away from the system

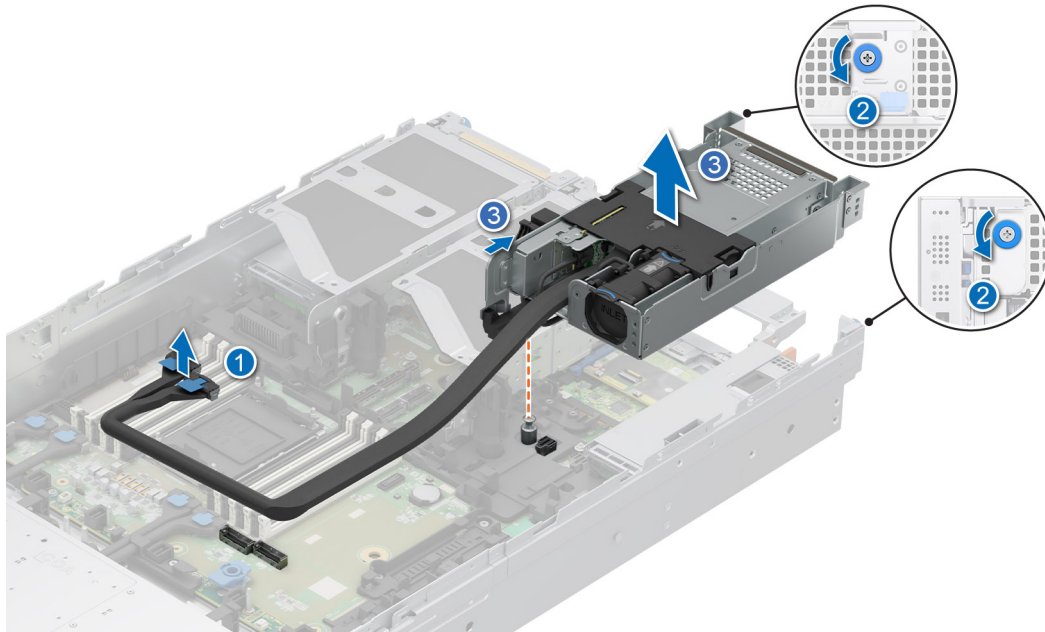

Figure 66. Removing the rear 4 x EDSFF E3.S module

Next steps

1. [Replace the rear 4 x EDSFF E3.S module.](#)

Installing the rear EDSFF E3.S module

Prerequisites

1. Follow the safety guidelines listed in the [Safety instructions](#).
2. Follow the procedure listed in the [Before working inside your system](#).
3. [Remove the system cover.](#)
4. [Remove the air shroud.](#)
5. [Remove the rear EDSFF E3.S drives.](#)
6. Disconnect the power cable and other required cables, observe the cable routing.

i **NOTE:** See [cable routing](#) section.

Steps

1. Align the slot on the rear drive module with the guide on the system.
2. Lower and press the rear drive module on top of the riser until firmly seated.
3. Using a Phillips #2 screwdriver, tighten the captive screws that secure the rear drive module into the system.

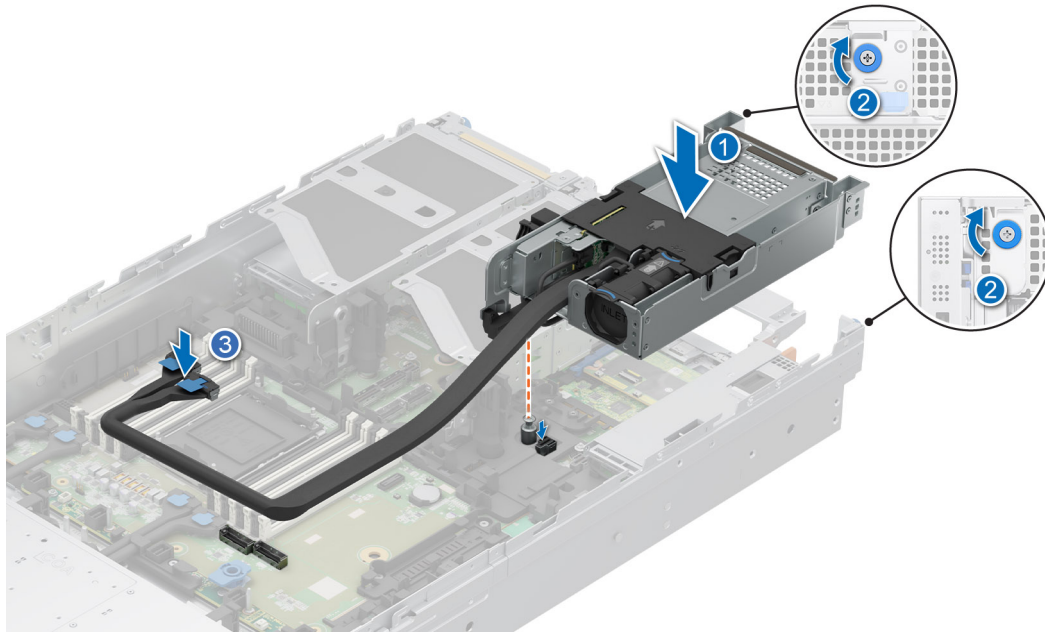

Figure 67. Installing the rear EDSFF E3.S module

Next steps

1. Connect all the cables, and ensure that all the cables are routed through the respective cable clip.

NOTE: See [cable routing](#) section.

2. [install the rear EDSFF E3.S drives.](#)
3. [Install the air shroud.](#)
4. [Install the system cover.](#)
5. Follow the procedure listed in [After working inside your system.](#)

Drive backplane

This is a service technician replaceable part only.

Drive backplane

Depending on your system configuration, the drive backplanes that are supported are listed here:

Table 51. Supported backplane options

System	Supported drive backplanes
PowerEdge R570	2U 8 x E3.S Gen5x4/x2 ortho backplane
	2U 8 x 2.5 Uni backplane
	2U 12 x 3.5 SAS3/SATA backplane
	2U 16 x 2.5 SAS3/SATA backplane
	2U 24 x 2.5 SAS3/SATA backplane
	2U 4 x E3.S Gen5x4 ortho (Rear) backplane

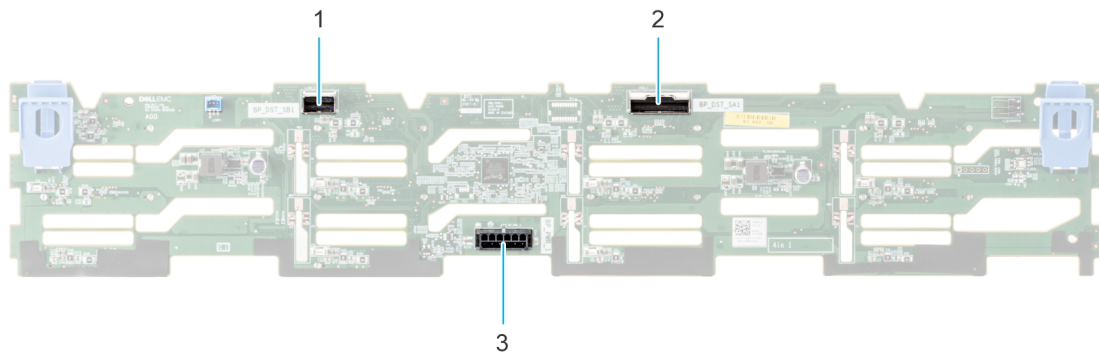

Figure 68. 12 x 3.5-inch drive backplane

1. BP_DST_SB1
2. BP_DST_SA1
3. BP_PWR_1 (backplane power cable to HPM board)

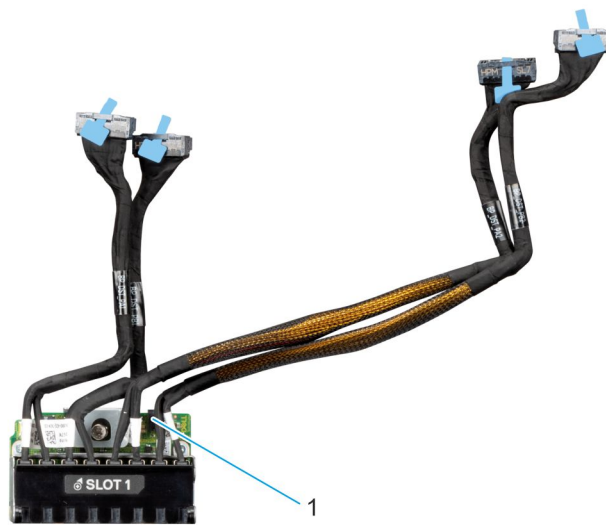

Figure 69. EDSFF E3.S NVMe drive backplane

1. BP_PWR_1 (backplane power cable to system board)

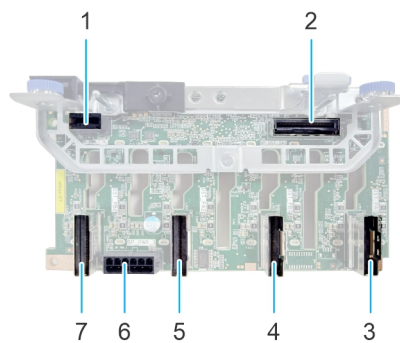

Figure 70. 8 x 2.5-inch Universal drive backplane

- | | |
|-------------------------------------|--|
| 1. BP_PWR_CTRL | 2. BP_DST_SA1 (PERC to backplane) |
| 3. BP_DST_PA1 (PCIe/NVMe connector) | 4. BP_DST_PB1 (PCIe/NVMe connector) |
| 5. BP_DST_PA2 (PCIe/NVMe connector) | 6. BP_PWR_1 (backplane power cable to HPM board) |
| 7. BP_DST_PB2 (PCIe/NVMe connector) | |

NOTE: For more information about cable routing, see the [Cable routings](#) topic.

Removing the 2.5-inch drive backplane module

Prerequisites

1. Follow the safety guidelines listed in the [Safety instructions](#).
2. Follow the procedure listed in the [Before working inside your system](#).
3. [Remove the system cover](#).
4. If installed [Remove the front bezel](#).
5. [Remove the air shroud](#).
6. [Remove the drive backplane cover](#).
7. [Remove the 2.5-inch drives](#).
8. Disconnect the power cable and other required cables, observe the cable routing.

 **NOTE:** See [cable routing](#) section.

Steps

1. Pinch and press the release clips on the backplane to disengage it from the system.
2. Lift it towards the rear of the system to remove the backplane.

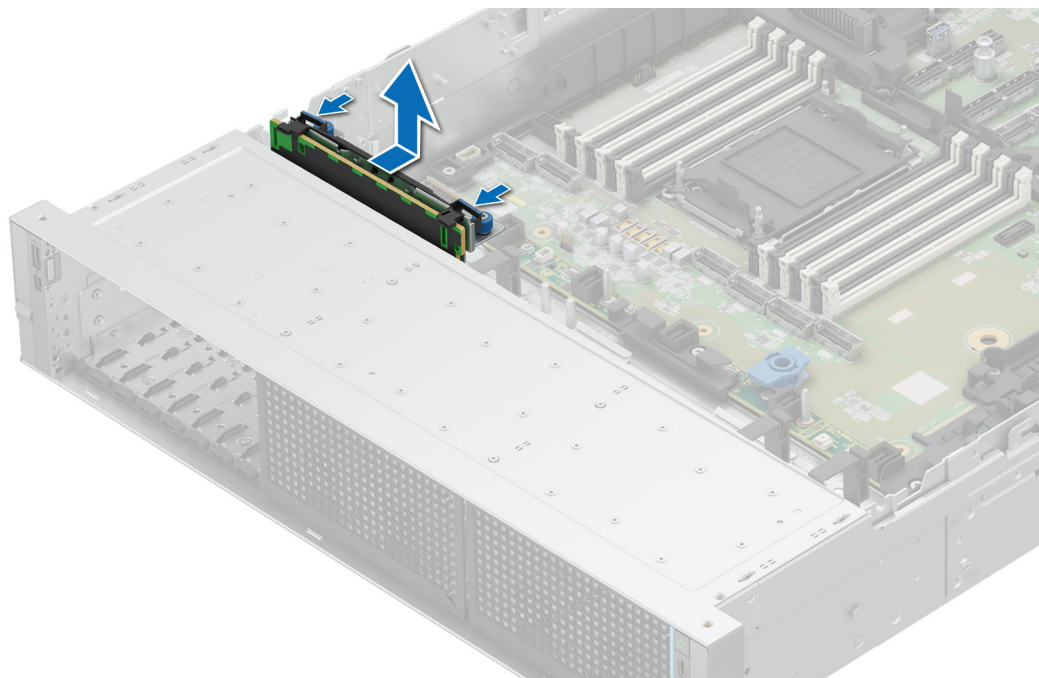

Figure 71. Removing the 2.5 inch drive backplane module

Next steps

1. [Replace the 2.5-inch drive backplane module](#).

Installing the 2.5-inch drive backplane module

Prerequisites

1. Follow the safety guidelines listed in the [Safety instructions](#).
2. Follow the procedure listed in the [Before working inside your system](#).
3. [Remove the system cover](#).
4. If installed [Remove the front bezel](#).
5. [Remove the air shroud](#).

6. Remove the drive backplane cover.
7. Remove the 2.5-inch drives.
8. Disconnect the power cable and other required cables, observe the cable routing.

NOTE: See [cable routing](#) section.

Steps

1. Align the 2.5-inch drive backplane module with the notches on the system.
2. Pinch and press the release clips on the backplane.
3. Lower the backplane into the system till firmly seated.

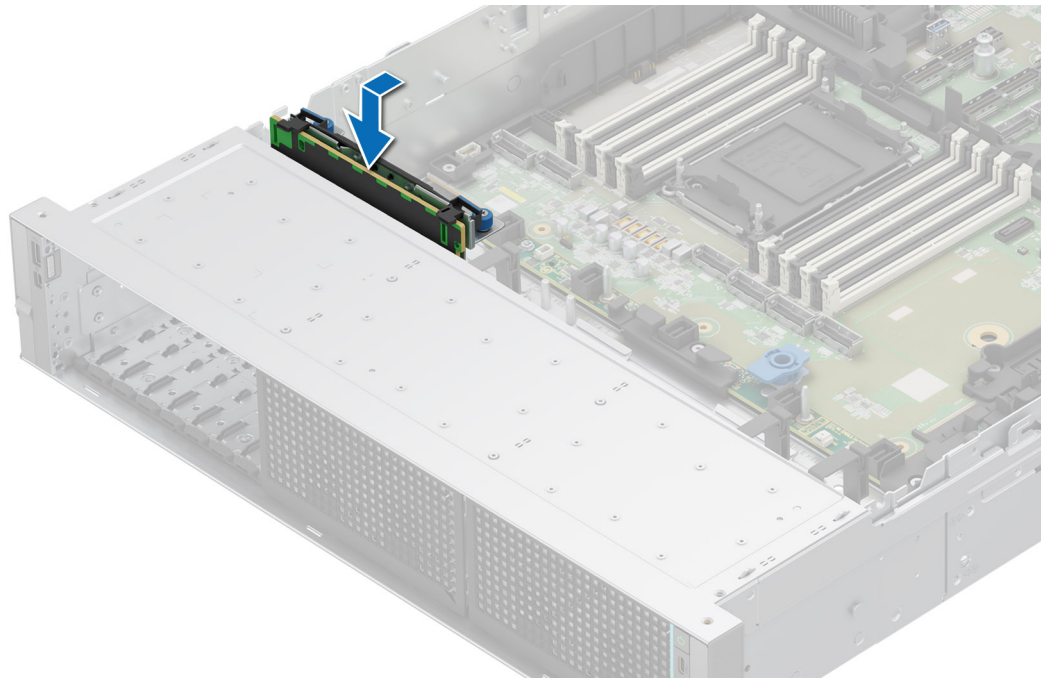

Figure 72. Installing the 2.5-inch drive backplane module

Next steps

1. Connect all the cables, and ensure that all the cables are routed through the respective cable clip.

NOTE: See [cable routing](#) section.

2. [install the 2.5-inch drives.](#)
3. If removed [Install the front bezel.](#)
4. [Install the drive backplane cover.](#)
5. [Install the air shroud.](#)
6. [Install the system cover](#)
7. Follow the procedure listed in [After working inside your system.](#)

Removing the 3.5-inch drive backplane module

Prerequisites

1. Follow the safety guidelines listed in the [Safety instructions.](#)
2. Follow the procedure listed in the [Before working inside your system.](#)
3. [Remove the system cover.](#)
4. If installed [Remove the front bezel.](#)

5. Remove the air shroud.
6. Remove the drive backplane cover.
7. Remove the 3.5-inch drives.
8. Disconnect the power cable and other required cables, observe the cable routing.

NOTE: See [cable routing](#) section.

Steps

1. Pinch and press the release clips on the backplane to disengage it from the system.
2. Lift it towards the rear of the system to remove the backplane.

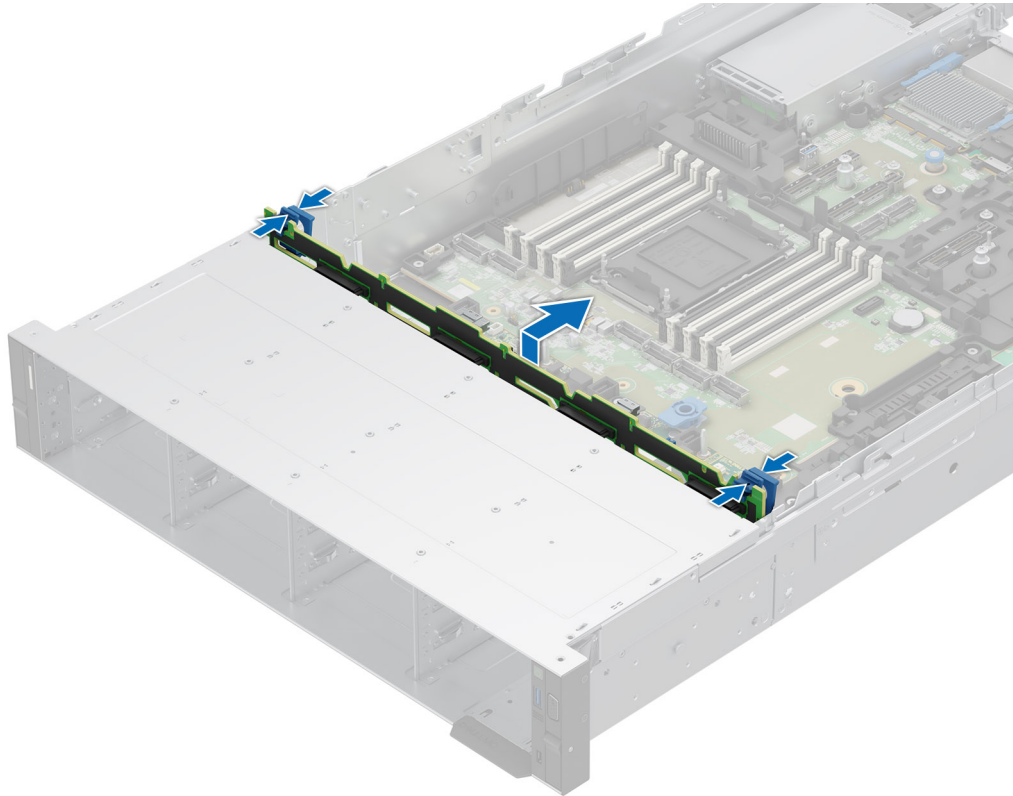

Figure 73. Removing the 3.5-inch drive backplane module

Next steps

1. [Replace the 3.5-inch drive backplane module.](#)

Installing the 3.5-inch drive backplane module

Prerequisites

1. Follow the safety guidelines listed in the [Safety instructions](#).
2. Follow the procedure listed in the [Before working inside your system](#).
3. [Remove the system cover.](#)
4. If installed [Remove the front bezel.](#)
5. [Remove the air shroud.](#)
6. [Remove the drive backplane cover.](#)
7. [Remove the 3.5-inch drives.](#)
8. Disconnect the power cable and other required cables, observe the cable routing.

NOTE: See [cable routing](#) section.

Steps

1. Align the 3.5-inch drive backplane module with the notches on the system.
2. Pinch and press the release clips on the backplane.
3. Lower the backplane into the system till firmly seated.

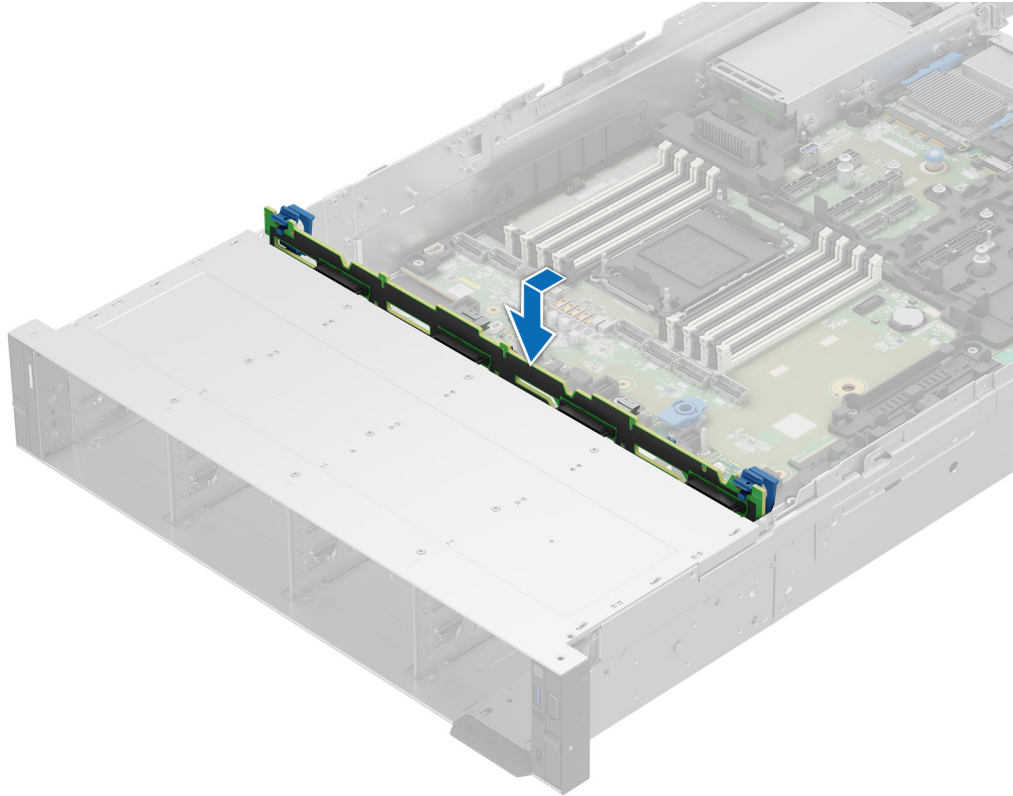

Figure 74. Installing the 3.5-inch drive backplane module

Next steps

1. Connect all the cables, and ensure that all the cables are routed through the respective cable clip.

NOTE: See [cable routing](#) section.

2. [install the 3.5-inch drives.](#)
3. If removed [Install the front bezel.](#)
4. [Install the drive backplane cover.](#)
5. [Install the air shroud.](#)
6. [Install the system cover.](#)
7. Follow the procedure listed in [After working inside your system.](#)

Removing the EDSFF E3.S backplane module

Prerequisites

1. Follow the safety guidelines listed in the [Safety instructions.](#)
2. Follow the procedure listed in the [Before working inside your system.](#)
3. [Remove the system cover.](#)
4. If installed [Remove the front bezel.](#)

5. Remove the air shroud.
6. Remove the drive backplane cover.
7. Remove the EDSFF E3.S drives.
8. Disconnect the power cable and other required cables, observe the cable routing.

NOTE: See [cable routing](#) section.

Steps

1. Using a Phillips 2 screwdriver, loosen the captive screws on the EDSFF E3.S backplane module.
2. Slide the EDSFF E3.S backplane module towards the front of the server and lift it to remove from the system.

NOTE: The numbers on the image do not depict the exact steps. The numbers are for representation of sequence.

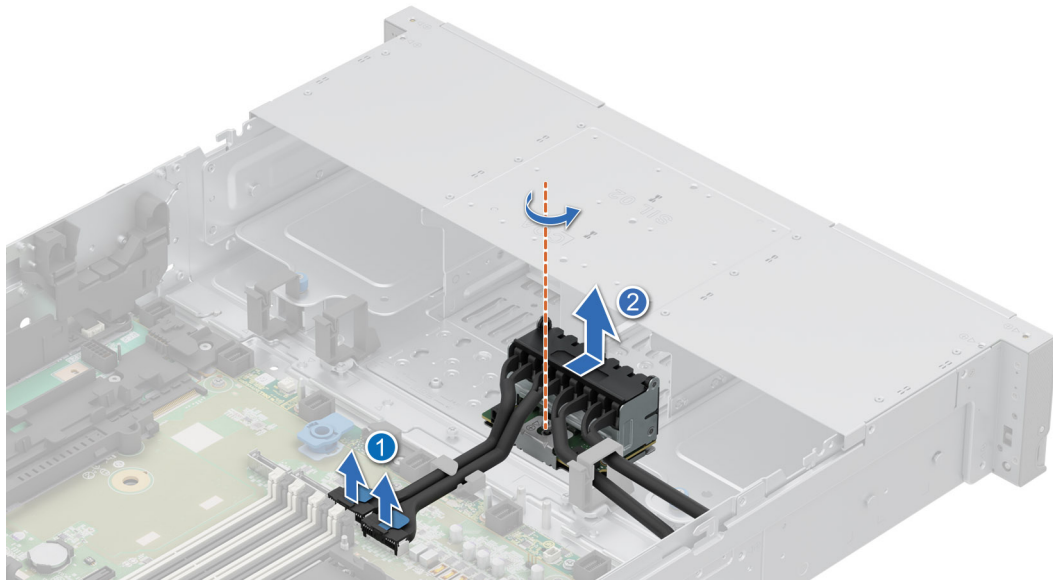

Figure 75. Removing the EDSFF E3.S backplane module

Next steps

1. [Replace the EDSFF E3.S backplane module.](#)

Installing the EDSFF E3.S backplane module

Prerequisites

1. Follow the safety guidelines listed in the [Safety instructions](#).
2. Follow the procedure listed in the [Before working inside your system](#).
3. [Remove the system cover.](#)
4. If installed [Remove the front bezel.](#)
5. [Remove the air shroud.](#)
6. [Remove the drive backplane cover.](#)
7. [Remove the EDSFF E3.S drives.](#)
8. Disconnect the power cable and other required cables, observe the cable routing.

NOTE: See [cable routing](#) section.

Steps

1. Align the EDSFF E3.S backplane module with the guide pin on the backplane bracket and position it from the top down, ensuring proper alignment.

NOTE: Locate and place the EDSFF E3.S backplane module on the unlocked position line.

2. Push the module towards the rear of the server until it is secured in place.
3. Using a Phillips 2 screwdriver, tighten the captive screws to secure the module.

NOTE: The numbers on the image do not depict the exact steps. The numbers are for representation of sequence.

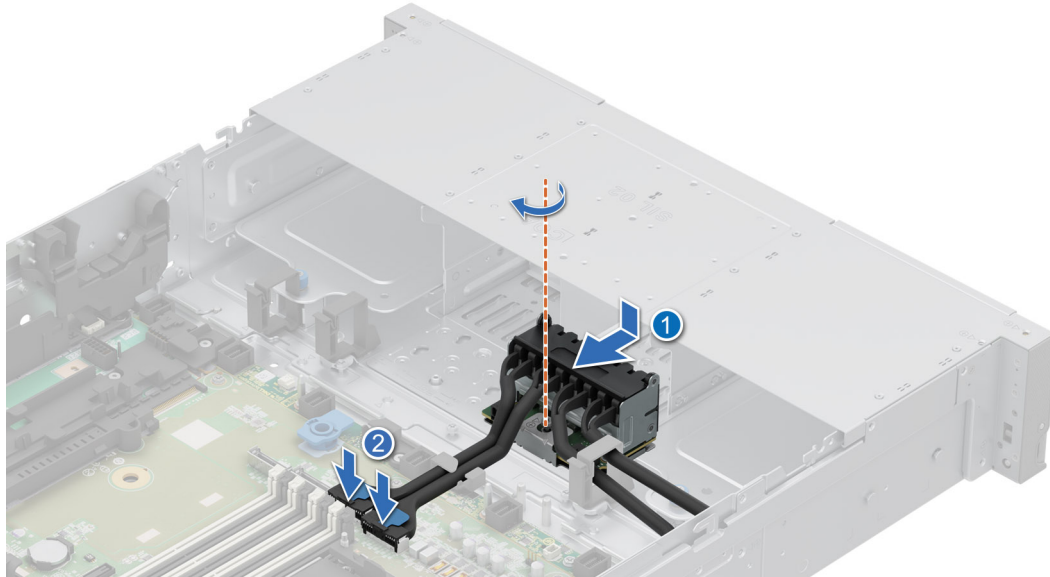

Figure 76. Installing the EDSFF E3.S backplane module

Next steps

1. Connect all the cables, and ensure that all the cables are routed through the respective cable clip.

NOTE: See [cable routing](#) section.

2. [install the EDSFF E3.S drives](#) .
3. If removed [Install the front bezel](#).
4. [Install the drive backplane cover](#).
5. [Install the air shroud](#).
6. [Install the system cover](#)
7. Follow the procedure listed in [After working inside your system](#).

Side wall brackets

Removing the side wall bracket

There are two side wall brackets on either side of the system. The procedure to remove is similar.

Prerequisites

1. Follow the safety guidelines listed in the [Safety instructions](#).
2. Follow the procedure listed in the [Before working inside your system](#).

3. [Remove the system cover.](#)

i **NOTE:** Ensure that you note the routing of the cables as you remove them from the system board. Route the cables properly when you replace them to prevent the cables from being pinched or crimped.

Steps

1. Press the side tabs to release the side wall cable holder.

i **NOTE:** Move the cables out of the side wall cable holder.

2. Press the center tab to release the bracket from the chassis, and lift it away from the system.

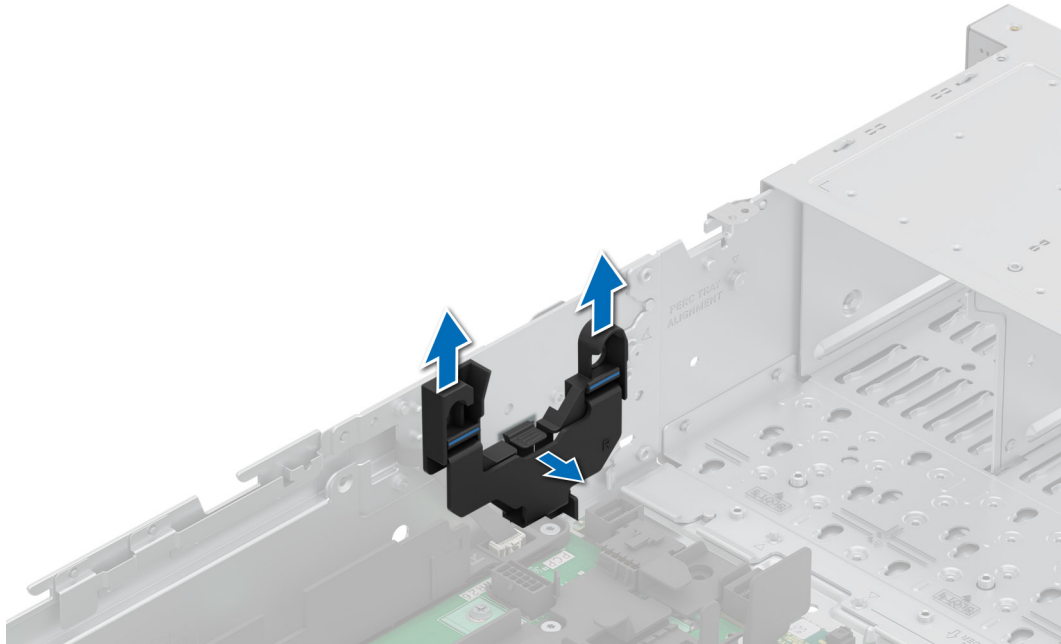

Figure 77. Removing the side wall bracket

Next steps

1. [Replace the side wall bracket.](#)

Installing the side wall bracket

There are two side wall brackets on either side of the system. The procedure to install is similar.

Prerequisites

1. Follow the safety guidelines listed in the [Safety instructions](#).
2. Follow the procedure listed in the [Before working inside your system](#).
3. [Remove the system cover.](#)

i **NOTE:** Ensure that you note the routing of the cables as you remove them from the system board. Route the cables properly when you replace them to prevent the cables from being pinched or crimped.

Steps

1. Align the guide slots on the side wall bracket with the guides on the system and slide until the cover is seated firmly.

i **NOTE:** Route the cables through the side wall cable holder.

2. Close the side wall cable holder until the holder clicks into place.

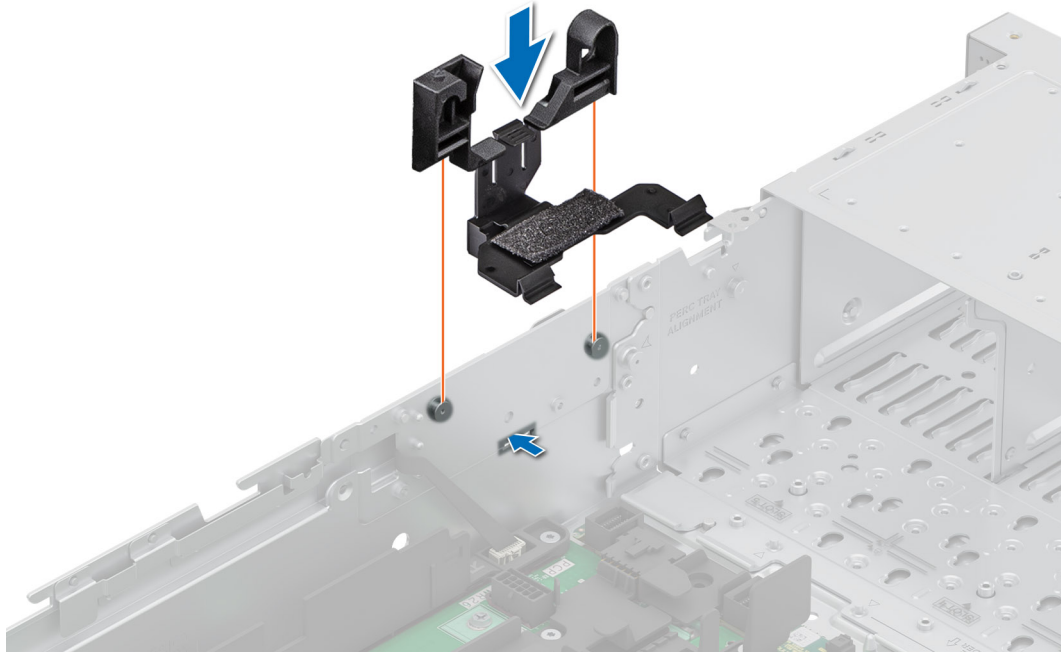

Figure 78. Installing the side wall bracket

Next steps

1. [Install the system cover.](#)
2. Follow the procedure listed in the [After working inside your system.](#)

Cable routings

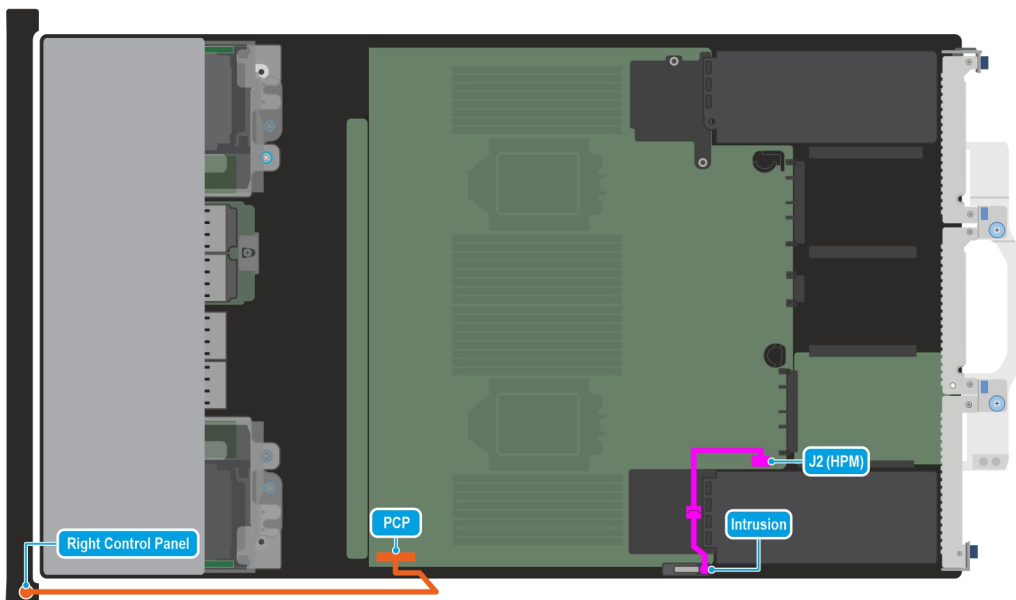

Figure 79. Right Control Panel - Primary (RCP) and Intrusion

NOTE: Follow the sequential order as shown in the table to remove the cables, to install the cables follow the reverse sequential order.

Table 52. Right Control Panel - Primary (RCP) and Intrusion

Order	From	To
1	HPM_RCP (signal connector on HPM for RCP)	Right Control Panel - Primary (RCP)
2	HPM_J2 (signal connector on HPM for intrusion switch)	Intrusion

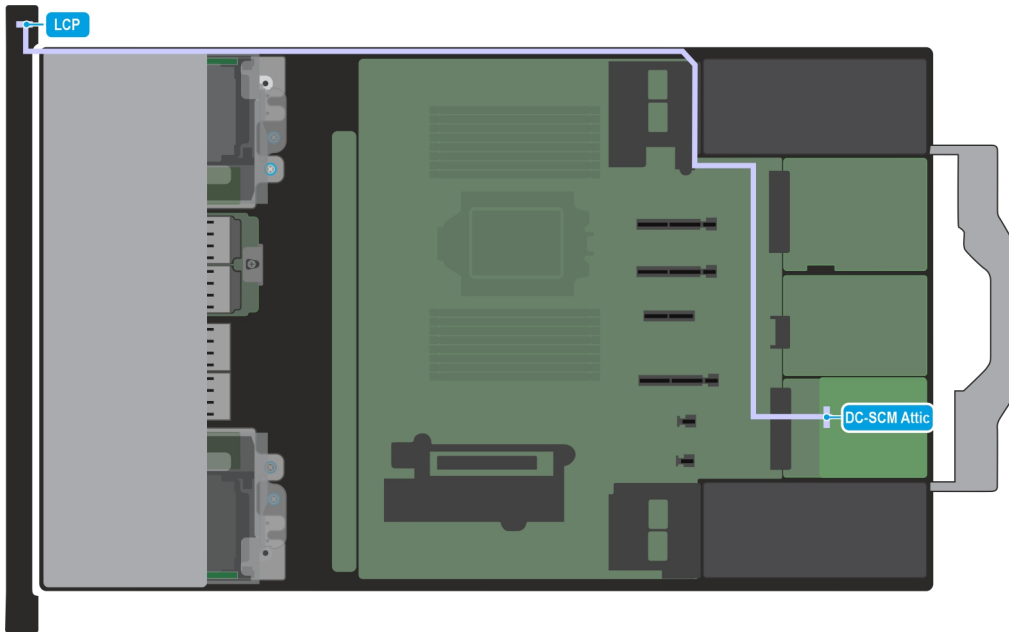

Figure 80. Left Control Panel - Secondary (LCP) and DC-SCM Attic

NOTE: Follow the sequential order as shown in the table to remove the cables, to install the cables follow the reverse sequential order.

Table 53. Left Control Panel - Secondary (LCP) and DC-SCM Attic

Order	From	To
1	DC-SCM (Attic)	Left Control Panel - Secondary (LCP)

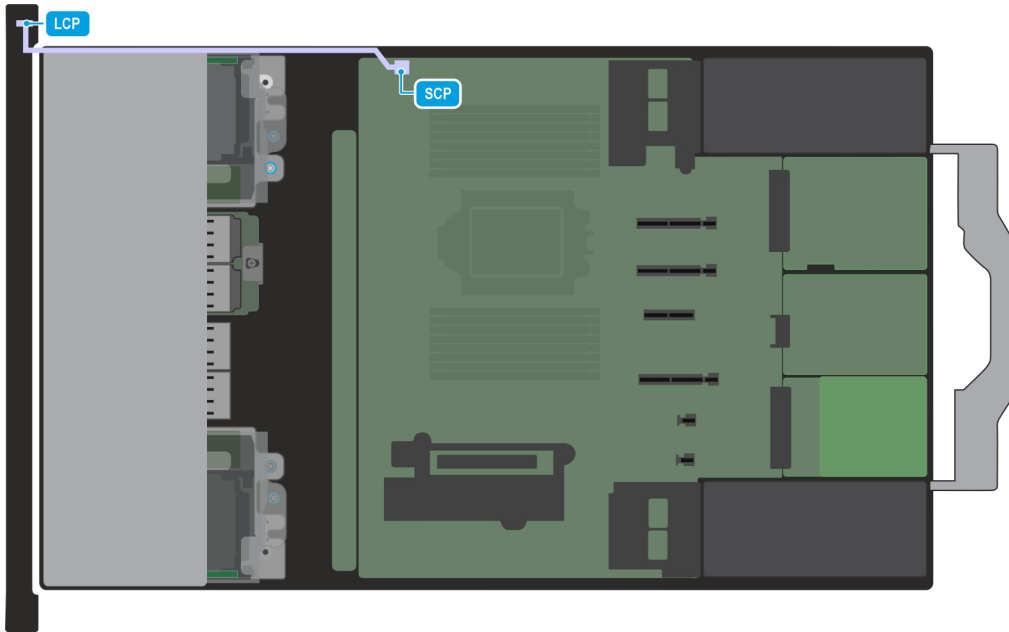

Figure 81. Left Control Panel - Secondary (LCP) Quick Sync module

NOTE: Follow the sequential order as shown in the table to remove the cables, to install the cables follow the reverse sequential order.

Table 54. Left Control Panel - Secondary (LCP) Quick Sync module

Order	From	To
1	SCP (HPM connector)	Left Control Panel - Secondary (LCP)



Figure 82. DPUs = R5 card

NOTE: Follow the sequential order as shown in the table to remove the cables, to install the cables follow the reverse sequential order.

Table 55. DPU = R5 card

Order	From	To
1	HPM_PWR7/8 (HPM power connector)	DPU PWR (R5)



Figure 83. DPU - R4 card

NOTE: Follow the sequential order as shown in the table to remove the cables, to install the cables follow the reverse sequential order.

Table 56. DPU - R4 card

Order	From	To
1	HPM_PWR7/8 (HPM power connector)	DPU PWR (R4)

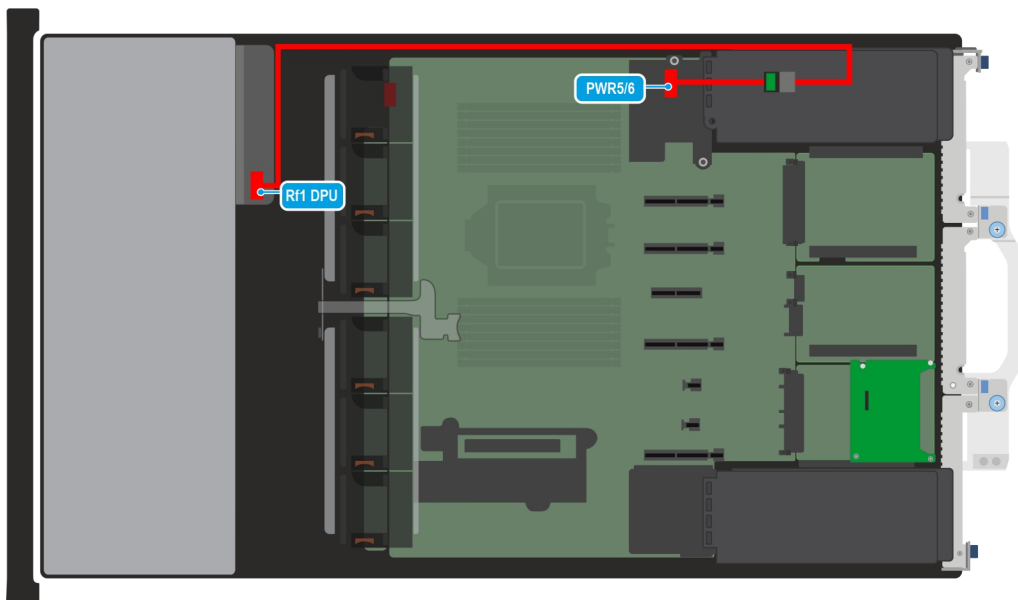

Figure 84. DPU - Rf1

NOTE: Follow the sequential order as shown in the table to remove the cables, to install the cables follow the reverse sequential order.

Table 57. DPU - RF1

Order	From	To
1	HPM_PWR5/6 (HPM power connector)	DPU PWR (R4)

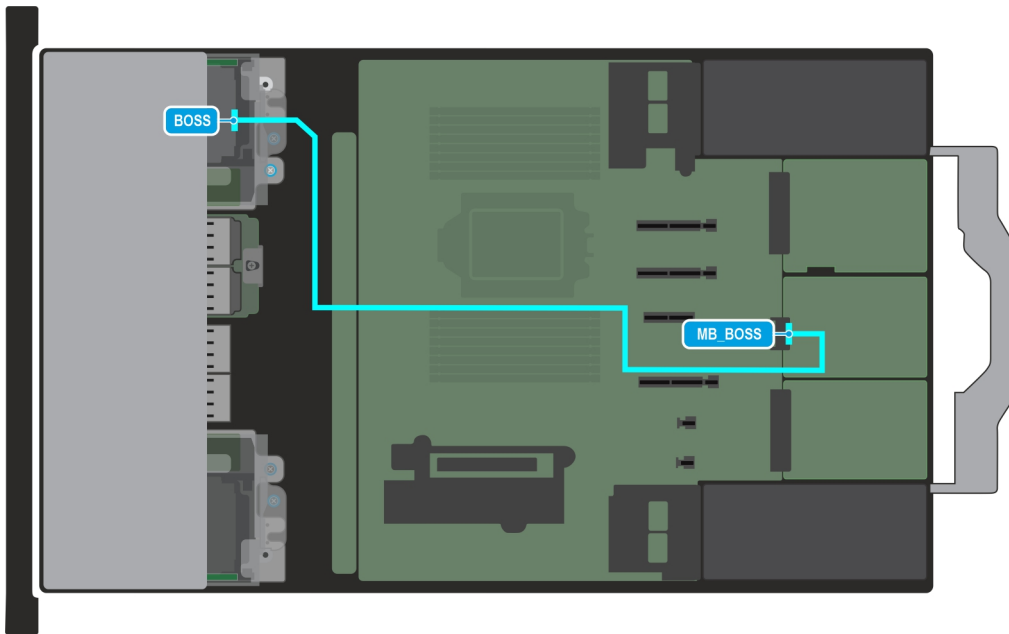

Figure 85. Front BOSS

NOTE: Follow the sequential order as shown in the table to remove the cables, to install the cables follow the reverse sequential order.

Table 58. Front BOSS

Order	From	To
1	HPM_BOSS (BOSS connector on HPM)	Front BOSS (BOSS Module)

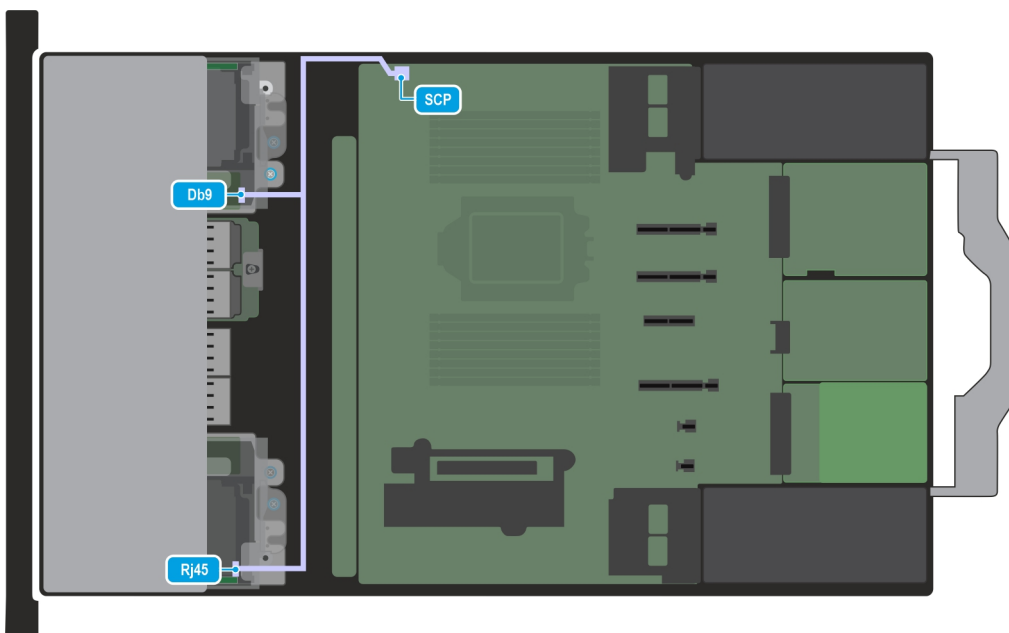

Figure 86. RJ45 and Serial Cable

NOTE: Follow the sequential order as shown in the table to remove the cables, to install the cables follow the reverse sequential order.

Table 59. RJ45 and Serial Cable

Order	From	To
1	HPM_SCP (HPM)	RJ45/DB9 (RJ45/Serial)

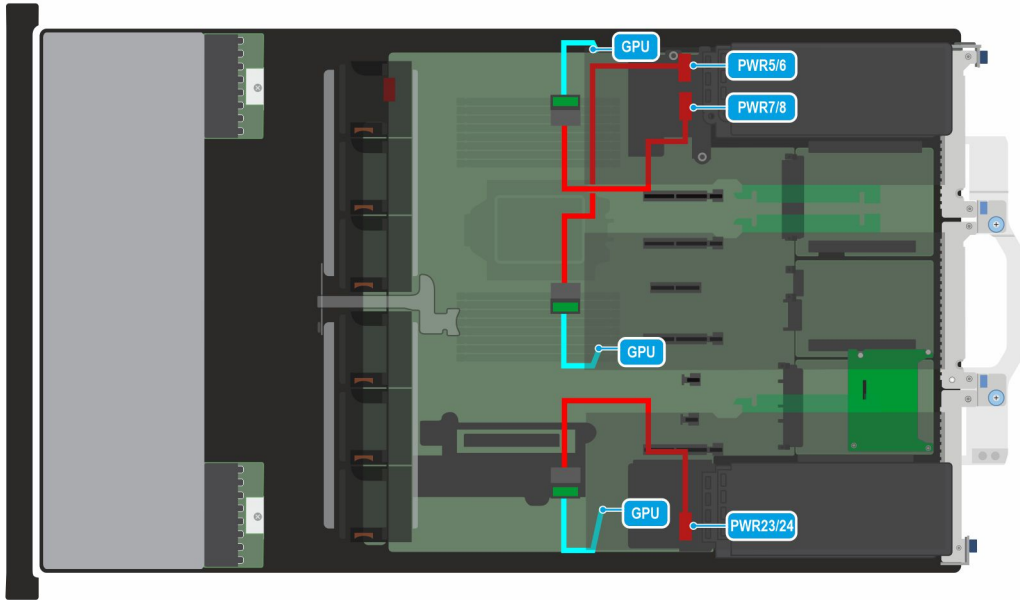

Figure 87. GPU Cable

NOTE: Follow the sequential order as shown in the table to remove the cables, to install the cables follow the reverse sequential order.

Table 60. GPU Cable

Order	From	To
1	HPM_PWR7/8 (HPM power connector)	R5 (GPU power connector)
2	HPM_PWR5/6 (HPM power connector)	R3 (GPU power connector)
3	HPM_PWR23/24 (HPM power connector)	R1 (GPU power connector)

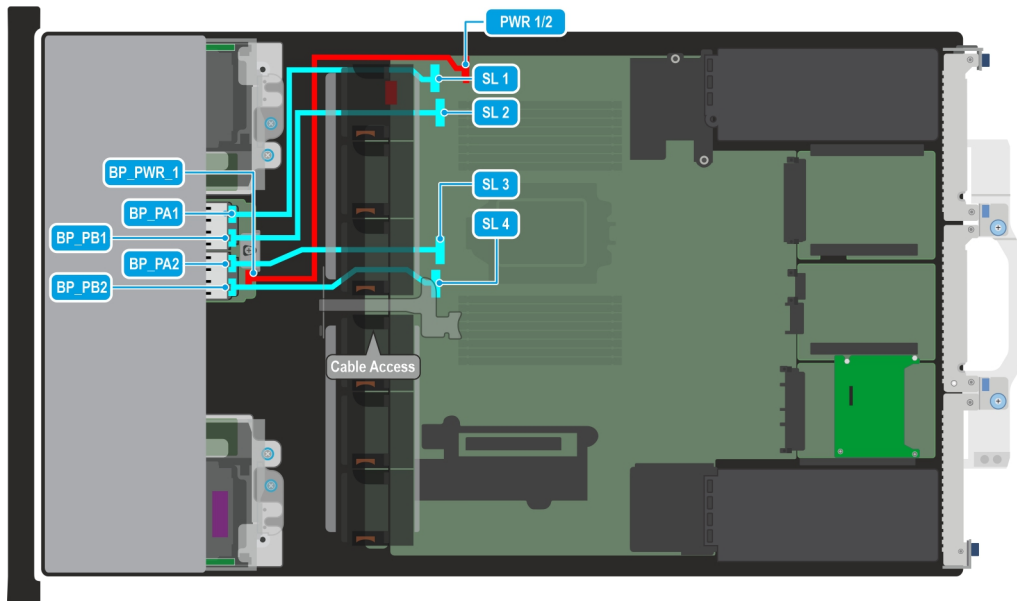

Figure 88. C01-01 Cable Config 0: 8 x EDSFF E3.S (G5x4 NVMe Direct Connect) - Cold Aisle

NOTE: Follow the sequential order as shown in the table to remove the cables, to install the cables follow the reverse sequential order.

Table 61. C01-01 Cable Config 0: 8 x EDSFF E3.S (G5x4 NVMe Direct Connect) - Cold Aisle

Order	From	To
1	HPM_PWR1/2 (power connector on HPM)	BP_PWR_1 (power connector on backplane)
2	HPM_SL1 (signal connector on HPM)	BP_DST_PA1 (E3.S backplane signal connector)
3	HPM_SL2 (signal connector on HPM)	BP_DST_PB1 (E3.S backplane signal connector)
4	HPM_SL3 (signal connector on HPM)	BP_DST_PA2 (E3.S backplane signal connector)
5	HPM_SL4 (signal connector on HPM)	BP_DST_PB2 (E3.S backplane signal connector)

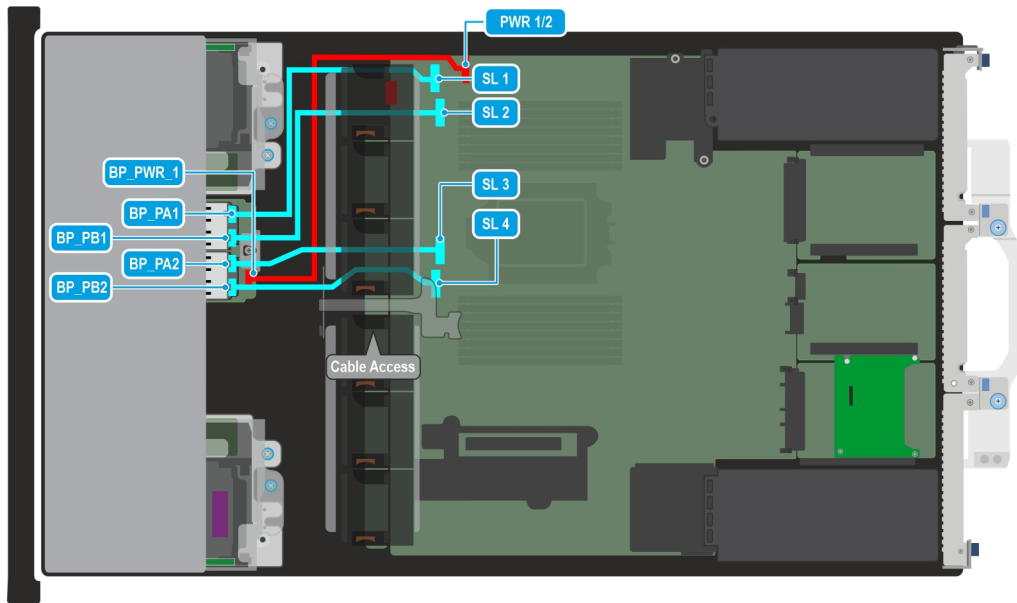

Figure 89. C01-02 Cable Config 1: 8 x EDSFF E3.S (G5x4 NVMe Direct Connect) - Cold Aisle

NOTE: Follow the sequential order as shown in the table to remove the cables, to install the cables follow the reverse sequential order.

Table 62. C01-02 Cable Config 1: 8 x EDSFF E3.S (G5x4 NVMe Direct Connect) - Cold Aisle

Order	From	To
1	HPM_PWR1/2 (power connector on HPM)	BP_PWR_1 (power connector on backplane)
2	HPM_SL1 (signal connector on HPM)	BP_DST_PA1 (E3.S backplane signal connector)
3	HPM_SL2 (signal connector on HPM)	BP_DST_PB1 (E3.S backplane signal connector)
4	HPM_SL3 (signal connector on HPM)	BP_DST_PA2 (E3.S backplane signal connector)
5	HPM_SL4 (signal connector on HPM)	BP_DST_PB2 (E3.S backplane signal connector)

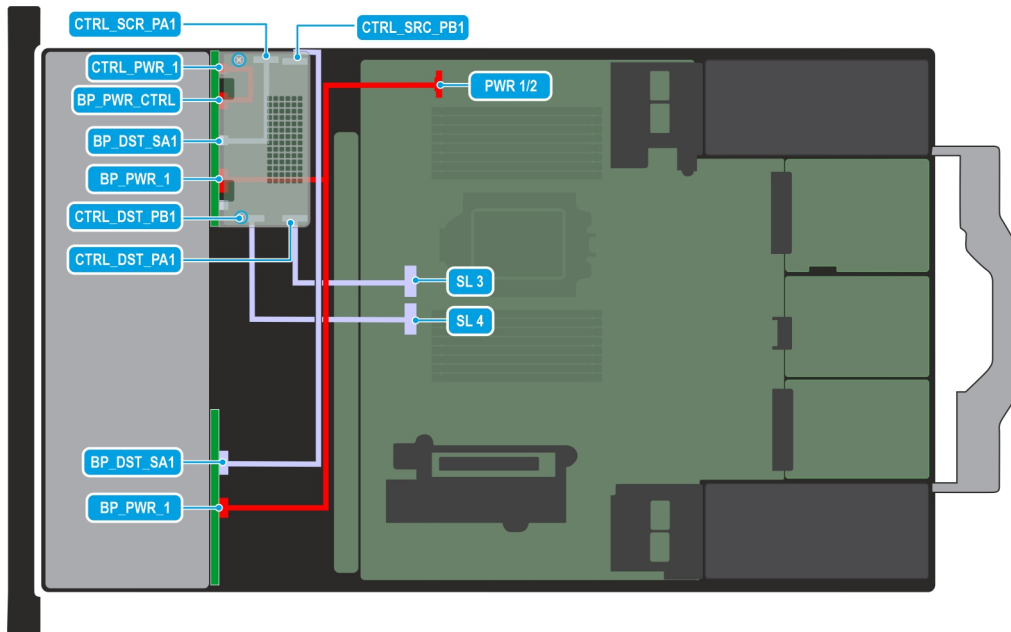

Figure 90. C02-01 Cable Config 2: 16 x 2.5-inch (SAS4/SATA)

NOTE: Follow the sequential order as shown in the table to remove the cables, to install the cables follow the reverse sequential order.

Table 63. C02-01 Cable Config 2: 16 x 2.5-inch (SAS4/SATA)

Order	From	To
1	HPM_PWR1/2 (power connector on HPM)	BP_PWR_1 (power connector on backplanes)
2	BP_PWR_CTRL (backplane power)	CTRL_PWR_1 (fPERC power)
3	CTRL_SRC_SA1 (fPERC controller)	BP_DST_SA1 (backplane 1 signal connector)
4	HPM_SL3 (signal connector on HPM)	CTRL_DST_PA1 (PERC input)
5	HPM_SL4 (signal connector on HPM)	CTRL_DST_PB1 (PERC input)
6	CTRL_SRC_SB1 (fPERC controller)	BP_DST_SA1 (backplane 2 signal connector)

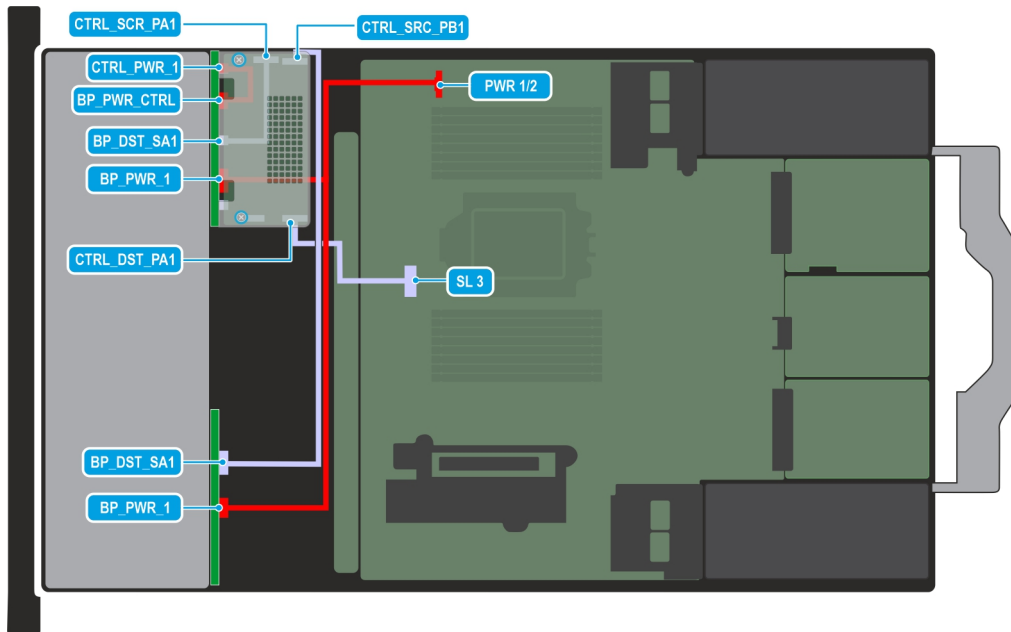

Figure 91. C02-02 Cable Config 3: 16 x 2.5-inch (SAS4/SATA)

NOTE: Follow the sequential order as shown in the table to remove the cables, to install the cables follow the reverse sequential order.

Table 64. C02-02 Cable Config 3: 16 x 2.5-inch (SAS4/SATA)

Order	From	To
1	HPM_PWR1/2 (power connector on HPM)	BP_PWR_1 (power connector on backplanes)
2	BP_PWR_CTRL (backplane power)	CTRL_PWR_1 (fPERC power)
3	CTRL_SRC_SA1 (fPERC controller)	BP_DST_SA1 (backplane 1 signal connector)
4	HPM_SL3 (signal connector on HPM)	CTRL_DST_PA1 (PERC input)
5	CTRL_SRC_SB1 (fPERC controller)	BP_DST_SA1 (backplane 2 signal connector)

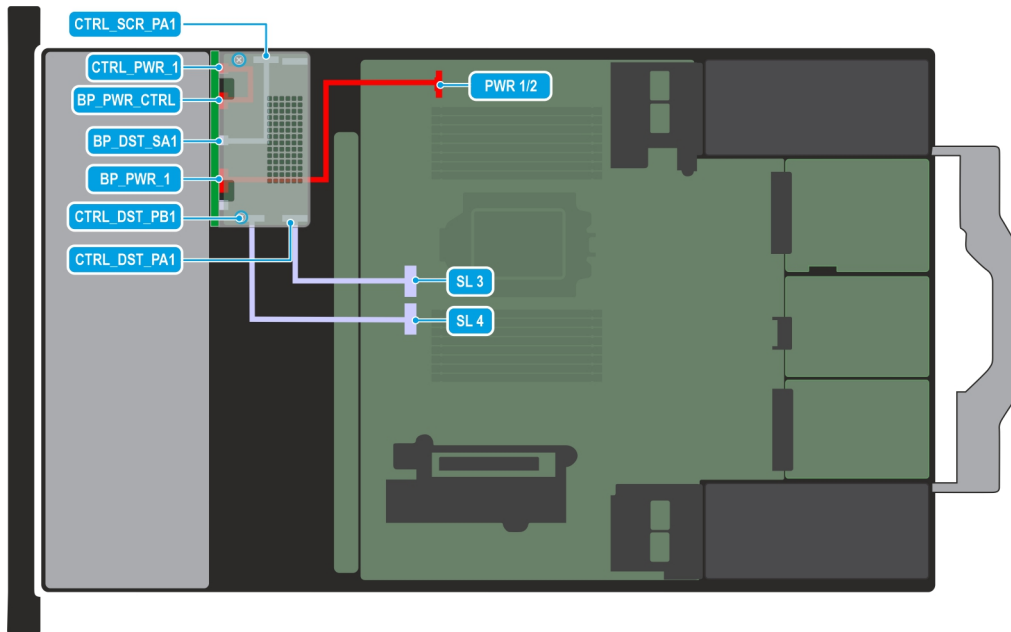

Figure 92. C03-01 Cable Config 4: 8 x 2.5-inch (SAS4/SATA)

NOTE: Follow the sequential order as shown in the table to remove the cables, to install the cables follow the reverse sequential order.

Table 65. C03-01 Cable Config 4: 8 x 2.5-inch (SAS4/SATA)

Order	From	To
1	HPM_PWR1/2 (power connector on HPM)	BP_PWR_1 (power connector on backplanes)
2	BP_PWR_CTRL (backplane power)	CTRL_PWR_1 (fPERC power)
3	CTRL_SRC_SA1 (fPERC controller)	BP_DST_SA1 (backplane signal connector)
4	HPM_SL3 (signal connector on HPM)	CTRL_DST_PA1 (PERC input)
5	HPM_SL4 (signal connector on HPM)	CTRL_DST_PB1 (PERC input)

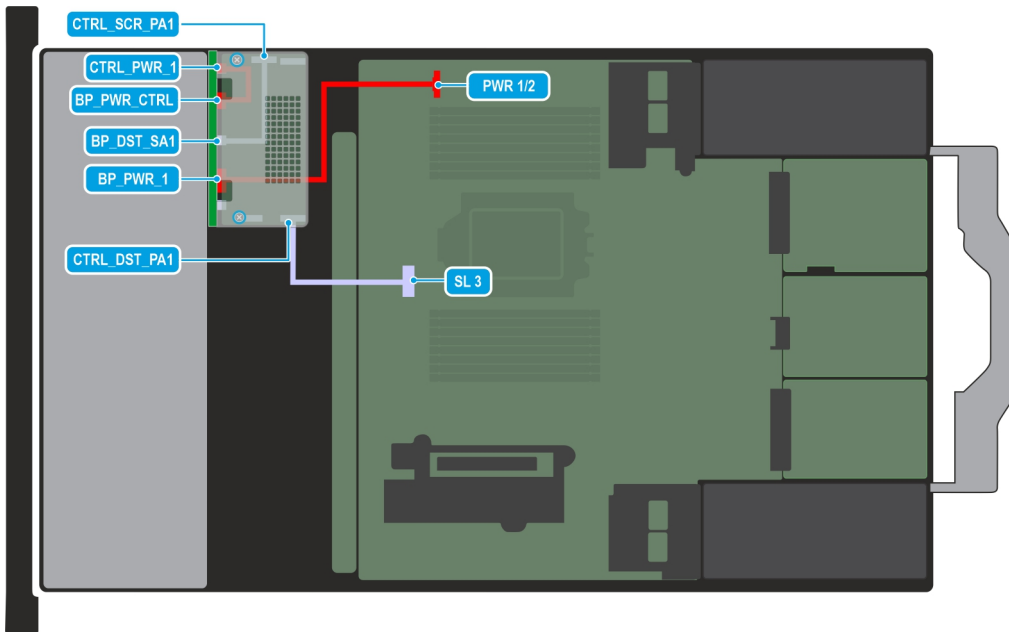

Figure 93. C03-02 Cable Config 5: 8 x 2.5-inch (SAS4/SATA)

NOTE: Follow the sequential order as shown in the table to remove the cables, to install the cables follow the reverse sequential order.

Table 66. C03-02 Cable Config 5: 8 x 2.5-inch (SAS4/SATA)

Order	From	To
1	HPM_PWR1/2 (power connector on HPM)	BP_PWR_1 (power connector on backplanes)
2	BP_PWR_CTRL (backplane power)	CTRL_PWR_1 (fPERC power)
3	CTRL_SRC_SA1 (fPERC controller)	BP_DST_SA1 (backplane signal connector)
4	HPM_SL3 (signal connector on HPM)	CTRL_DST_PA1 (PERC input)

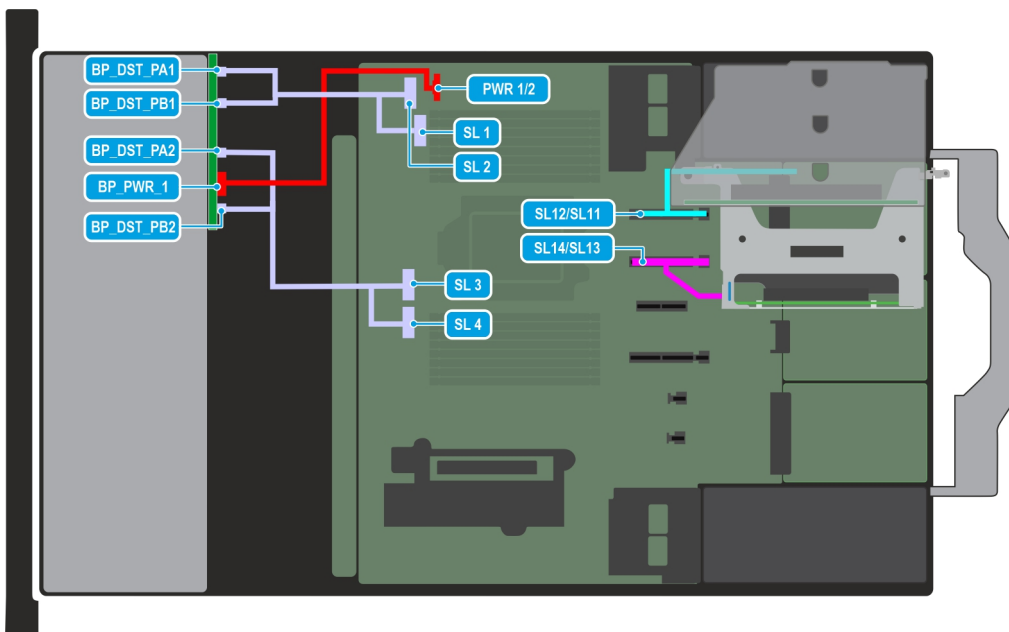

Figure 94. C03-07 Cable Config 6: 8 x 2.5-inch (G4 NVMe Direct Connect)

NOTE: Follow the sequential order as shown in the table to remove the cables, to install the cables follow the reverse sequential order.

Table 67. C03-07 Cable Config 6: 8 x 2.5-inch (G4 NVMe Direct Connect)

Order	From	To
1	HPM_PWR1/2 (power connector on HPM)	BP_PWR_1 (power connector on backplanes)
2	HPM_SL1/SL2 (signal connector on HPM)	BP_DST_PA1 and BP_DST_PB1 (backplane signal connector)
3	HPM_SL3/SL4 (signal connector on HPM)	BP_DST_PA2 and BP_DST_PB2 (backplane signal connector)
4	HPM_SL11/SL12 (signal connector on HPM)	R5b (Rear Riser 5b)
5	HPM_SL13/SL14 (signal connector on HPM)	R4b (Rear Riser 4b)

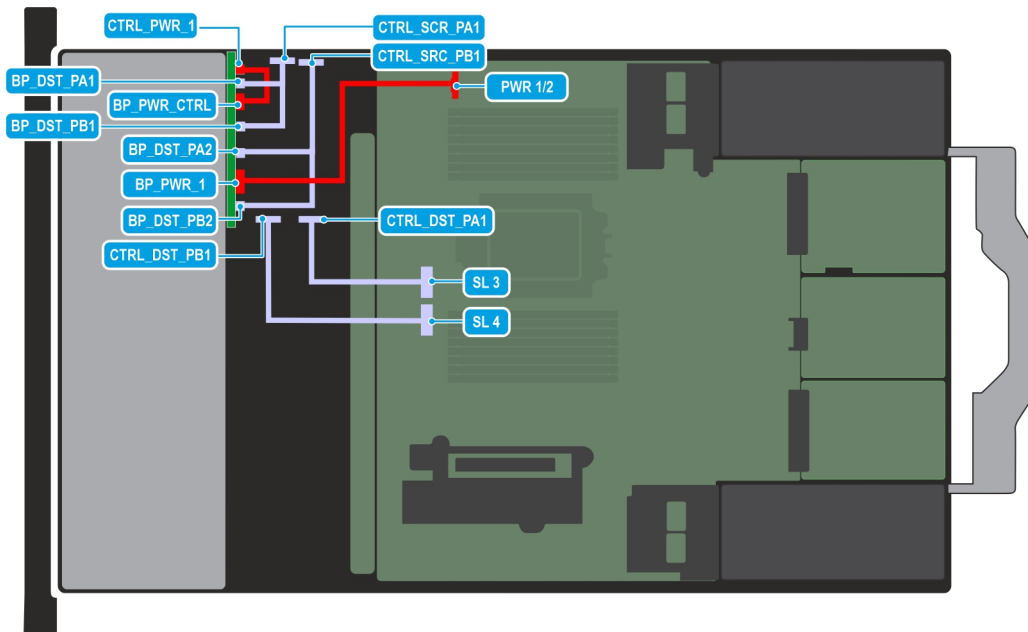

Figure 95. C03-08 Cable Config 7: 8 x 2.5-inch (G4 NVMe RAID)

NOTE: Follow the sequential order as shown in the table to remove the cables, to install the cables follow the reverse sequential order.

Table 68. C03-08 Cable Config 7: 8 x 2.5-inch (G4 NVMe RAID)

Order	From	To
1	HPM_PWR1/2 (power connector on HPM)	BP_PWR_1 (power connector on backplanes)
2	BP_PWR_CTRL (backplane power)	CTRL_PWR_1 (fPERC power)
3	HPM_SL3 (signal connector on HPM)	CTRL_DST_PA1 (PERC input)
4	HPM_SL4 (signal connector on HPM)	CTRL_DST_PB1 (PERC input)
5	CTRL_SRC_PA1 (fPERC controller)	BP_DST_PA1 and BP_DST_PB1 (backplane signal connector)
6	CTRL_SRC_PB1 (fPERC controller)	BP_DST_PA2 and BP_DST_PB2 (backplane signal connector)

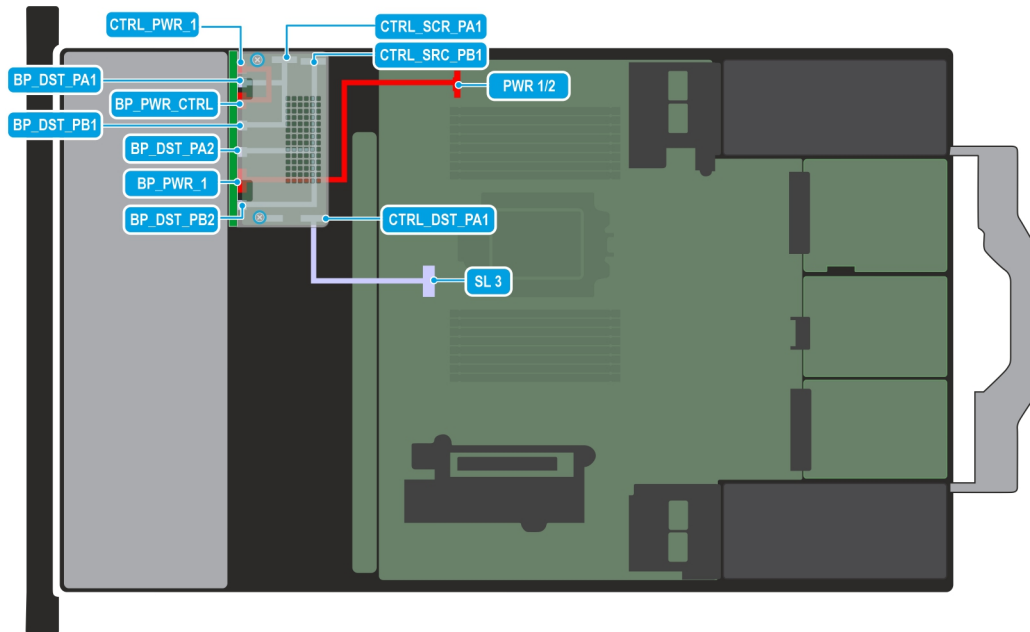

Figure 96. C03-09 Cable Config 8: 8 x 2.5-inch (G4 NVMe RAID)

NOTE: Follow the sequential order as shown in the table to remove the cables, to install the cables follow the reverse sequential order.

Table 69. C03-09 Cable Config 8: 8 x 2.5-inch (G4 NVMe RAID)

Order	From	To
1	HPM_PWR1/2 (power connector on HPM)	BP_PWR_1 (power connector on backplanes)
2	BP_PWR_CTRL (backplane power)	CTRL_PWR_1 (fPERC power)
3	HPM_SL3 (signal connector on HPM)	CTRL_DST_PA1 (PERC input)
4	HPM_SL4 (signal connector on HPM)	CTRL_DST_PB1 (PERC input)
5	CTRL_SRC_PA1 (fPERC controller)	BP_DST_PA1 and BP_DST_PB1 (backplane signal connector)
6	CTRL_SRC_PB1 (fPERC controller)	BP_DST_PA2 and BP_DST_PB2 (backplane signal connector)

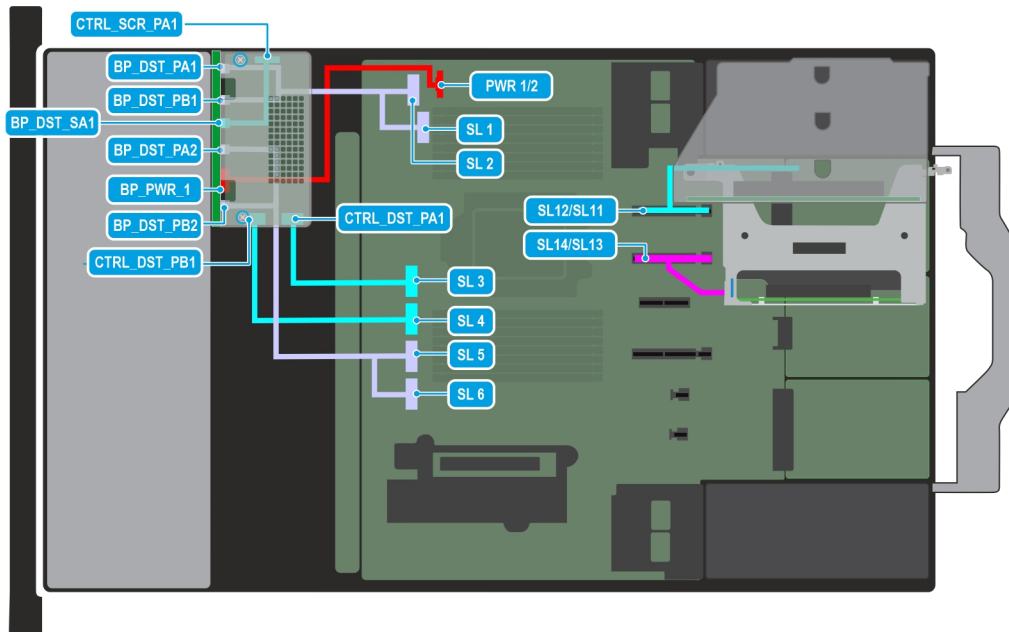

Figure 97. C03-011 Cable Config 9: 8 x 2.5-inch (Universal)

NOTE: Follow the sequential order as shown in the table to remove the cables, to install the cables follow the reverse sequential order.

Table 70. C03-011 Cable Config 9: 8 x 2.5-inch (Universal)

Order	From	To
1	HPM_PWR1/2 (power connector on HPM)	BP_PWR_1 (power connector on backplanes)
2	CTRL_SRC_PA1 (fPERC controller)	BP_DST_PA1 and BP_DST_PB1 (backplane signal connector)
3	CTRL_SRC_PA1 (fPERC controller)	BP_DST_PA1 and BP_DST_PB1 (backplane signal connector)
4	HPM_SL3 (signal connector on HPM)	CTRL_DST_PA1 (PERC input)
5	HPM_SL4 (signal connector on HPM)	CTRL_DST_PB1 (PERC input)
6	HPM_SL1/SL2 (signal connector on HPM)	BP_DST_PA1 and BP_DST_PB1 (backplane signal connector)
7	HPM_SL5/SL6 (signal connector on HPM)	BP_DST_PA2 and BP_DST_PB2 (backplane signal connector)
8	HPM_SL11/SL12 (signal connector on HPM)	R5b (rear riser)
9	HPM_SL13/SL14 (signal connector on HPM)	R4b (rear riser)

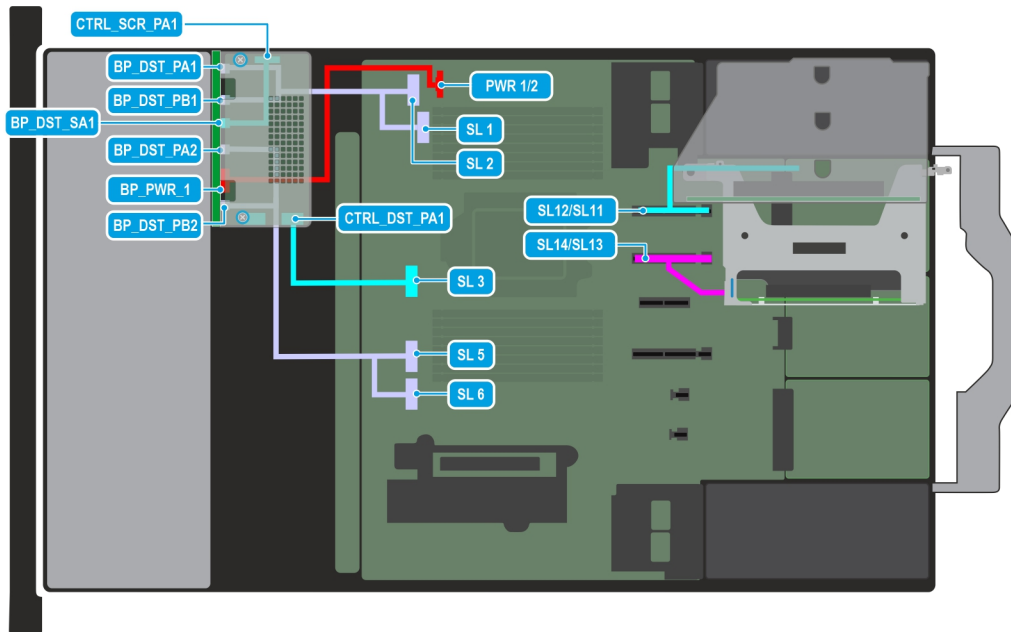

Figure 98. C03-012 Cable Config 10: 8 x 2.5-inch (Universal)

NOTE: Follow the sequential order as shown in the table to remove the cables, to install the cables follow the reverse sequential order.

Table 71. C03-012 Cable Config 10: 8 x 2.5-inch (Universal)

Order	From	To
1	HPM_PWR1/2 (power connector on HPM)	BP_PWR_1 (power connector on backplanes)
2	BP_PWR_CTRL (backplane power connector)	CTRL_PWR_11 (fPERC power connector)
3	CTRL_SRC_PA1 (fPERC controller)	BP_DST_PA1 and BP_DST_PB1 (backplane signal connector)
4	HPM_SL3 (signal connector on HPM)	CTRL_DST_PA1 (PERC input)
5	HPM_SL1/SL2 (signal connector on HPM)	BP_DST_PA1 and BP_DST_PB1 (backplane signal connector)
6	HPM_SL5/SL6 (signal connector on HPM)	BP_DST_PA2 and BP_DST_PB2 (backplane signal connector)
7	HPM_SL11/SL12 (signal connector on HPM)	R5b (rear riser)
8	HPM_SL13/SL14 (signal connector on HPM)	R4b (rear riser)

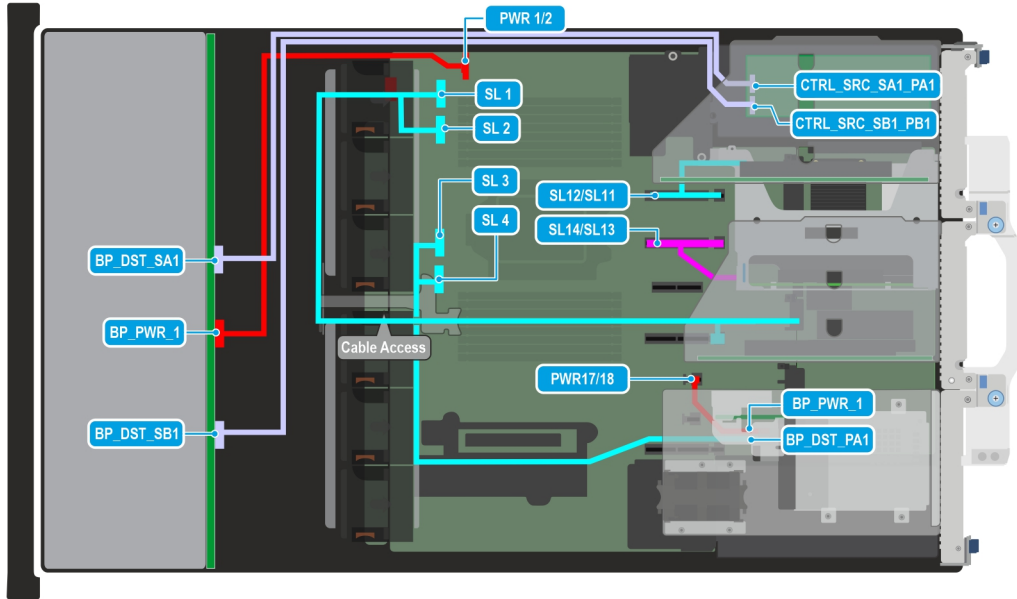

Figure 99. C04-01 Cable Config 11: 12 x 3.5-inch (SAS/SATA) + rear 4 x EDSFF E3.S (G5x4 NVMe Direct Connect)

NOTE: Follow the sequential order as shown in the table to remove the cables, to install the cables follow the reverse sequential order.

Table 72. C04-01 Cable Config 11: 12 x 3.5-inch (SAS/SATA) + rear 4 x EDSFF E3.S (G5x4 NVMe Direct Connect)

Order	From	To
1	HPM_PWR1/2 (power connector on HPM)	BP_PWR_1 (power connector on backplanes)
2	CTRL_SRC_SA1_PA1 (aPERC controller)	BP_DST_SA1 (backplane signal connector)
3	CTRL_SRC_SB1_PB1 (aPERC controller)	BP_DST_SB1 (backplane signal connector)
4	HPM_SL11/SL12 (signal connector on HPM)	R5b (Rear Riser 5b)
5	HPM_SL13/SL14 (signal connector on HPM)	R4b (Rear Riser 4b)
6	HPM_SL3/SL4 (signal connector on HPM)	Rear E3.S drive module
7	HPM_PWR17/18 (power connector on HPM)	Rear E3.S drive module power
8	HPM_SL1/SL2 (signal connector on HPM)	R3f (Riser 3f OCP)

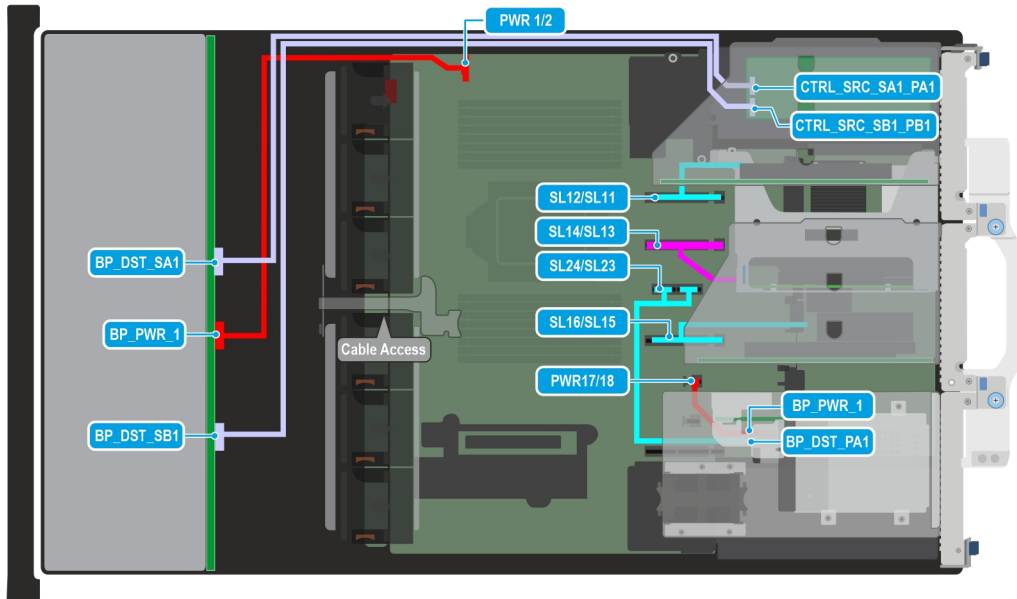

Figure 100. C04-02 Cable Config 20: 12 x 3.5-inch (SAS/SATA)

NOTE: Follow the sequential order as shown in the table to remove the cables, to install the cables follow the reverse sequential order.

Table 73. C04-02 Cable Config 20: 12 x 3.5-inch (SAS/SATA)

Order	From	To
1	HPM_PWR1/2 (power connector on HPM)	BP_PWR_1 (power connector on backplanes)
2	CTRL_SRC_SA1_PA1 (aPERC controller)	BP_DST_SA1 (backplane signal connector)
3	CTRL_SRC_SB1_PB1 (aPERC controller)	BP_DST_SB1 (backplane signal connector)
4	HPM_SL11/SL12 (signal connector on HPM)	R5b (Rear Riser 5b)
5	HPM_SL13/SL14 (signal connector on HPM)	R4b (Rear Riser 4b)
6	HPM_SL15/SL16 (signal connector on HPM)	R3e (Rear Riser 3e)
7	HPM_SL23/SL24 (signal connector on HPM)	R2t (Rear Riser 2t)

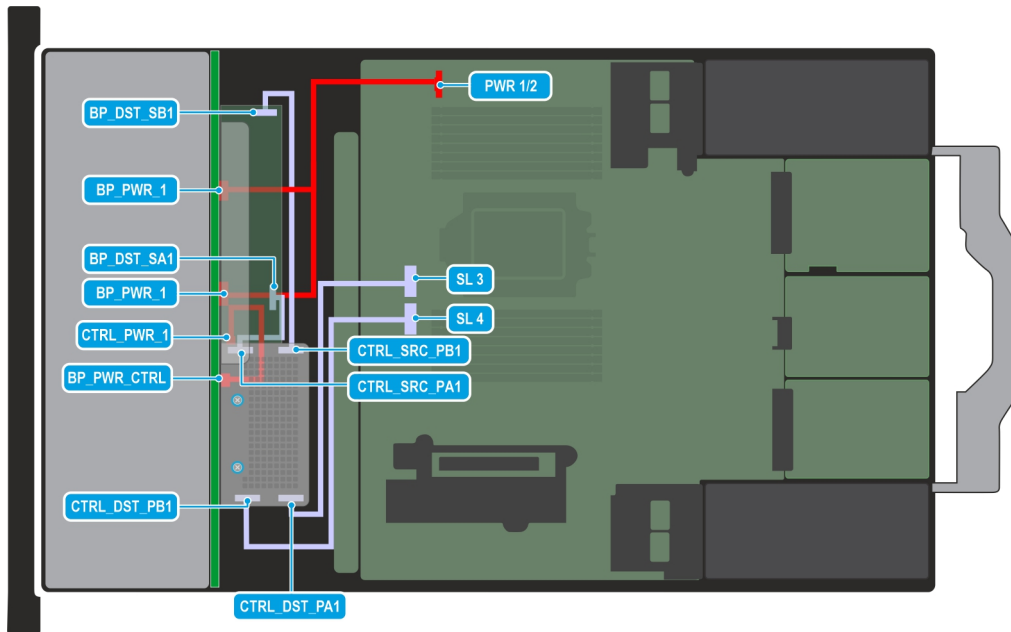

Figure 101. C05-01 Cable Config 12: 24 x 2.5-inch (SAS/SATA)

NOTE: Follow the sequential order as shown in the table to remove the cables, to install the cables follow the reverse sequential order.

Table 74. C05-01 Cable Config 12: 24 x 2.5-inch (SAS/SATA)

Order	From	To
1	HPM_PWR1/2 (power connector on HPM)	BP_PWR_1 (power connector on backplanes)
2	BP_PWR_CTRL (backplane power connector)	CTRL_PWR_1 (fPERC power connector)
3	CTRL_SRC_SA1 (fPERC controller)	BP_DST_SA1 (backplane signal connector)
4	CTRL_SRC_SB1 (fPERC controller)	BP_DST_SB1 (backplane signal connector)
5	CTRL_DST_PA1 (fPERC controller)	HPM_SL3 (signal connector on HPM)
6	CTRL_DST_PB1 (fPERC controller)	HPM_SL4 (signal connector on HPM)

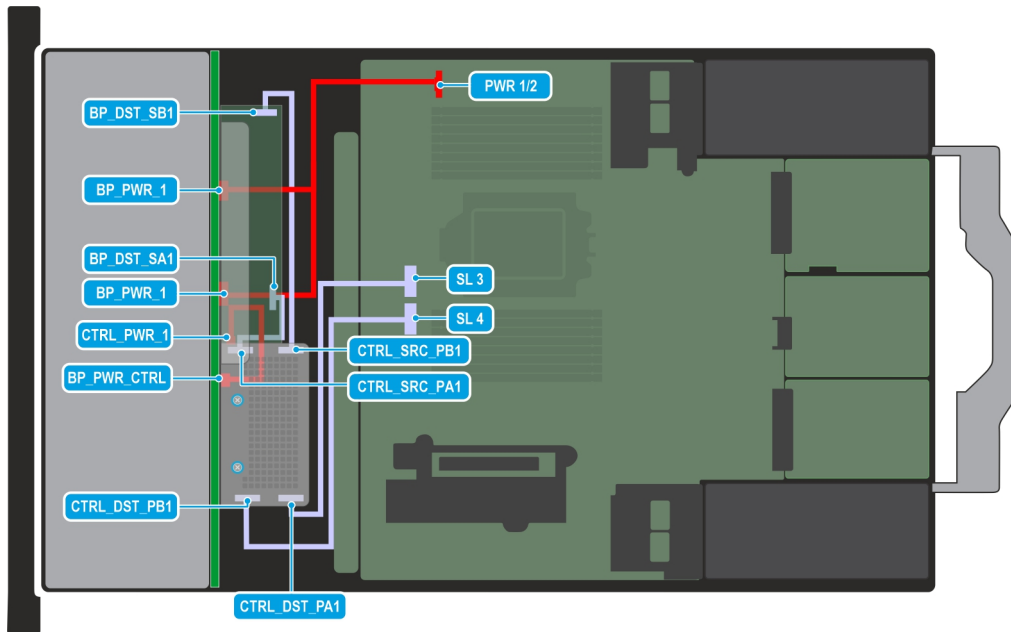

Figure 102. C05-02 Cable Config 13: 24 x 2.5-inch (SAS/SATA)

NOTE: Follow the sequential order as shown in the table to remove the cables, to install the cables follow the reverse sequential order.

Table 75. C05-02 Cable Config 13: 24 x 2.5-inch (SAS/SATA)

Order	From	To
1	HPM_PWR1/2 (power connector on HPM)	BP_PWR_1 (power connector on backplanes)
2	BP_PWR_CTRL (backplane power connector)	CTRL_PWR_1 (fPERC power connector)
3	CTRL_SRC_SA1 (fPERC controller)	BP_DST_SA1 (backplane signal connector)
4	CTRL_SRC_SB1 (fPERC controller)	BP_DST_SB1 (backplane signal connector)
5	CTRL_DST_PA1 (fPERC controller)	HPM_SL3 (signal connector on HPM)

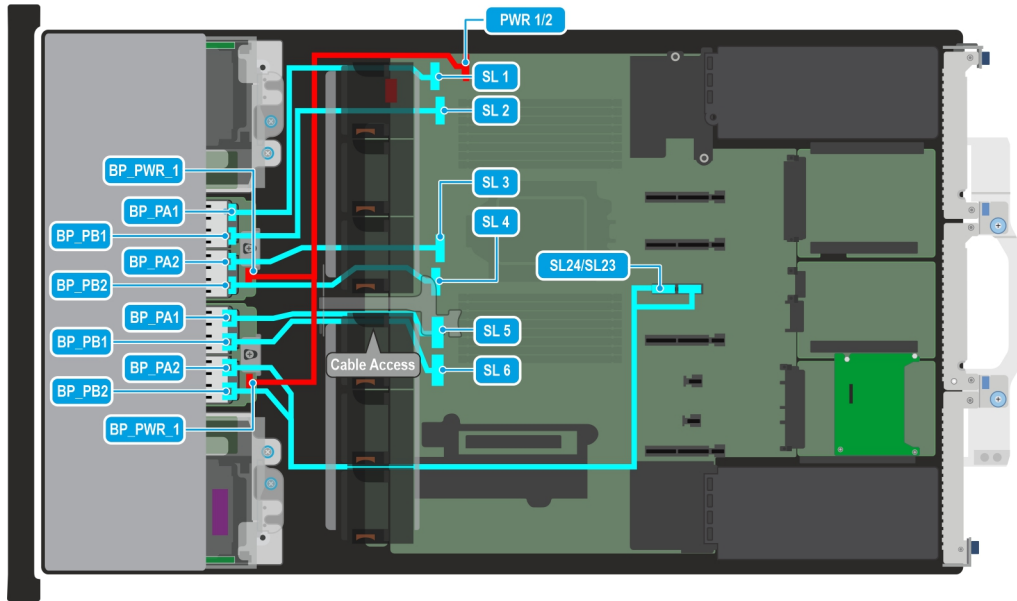

Figure 103. C06-01 Cable Config 14: 16 x EDSFF E3.S (G5x4 NVMe Direct Connect)

NOTE: Follow the sequential order as shown in the table to remove the cables, to install the cables follow the reverse sequential order.

Table 76. C06-01 Cable Config 14: 16 x EDSFF E3.S (G5x4 NVMe Direct Connect)

Order	From	To
1	HPM_PWR1/2 (power connector on HPM)	BP_PWR_1 (power connector on backplanes)
2	HPM_SL1 (signal connector on HPM)	BP_DST_PA1 (backplane signal connector)
3	HPM_SL2 (signal connector on HPM)	BP_DST_PB1 (backplane signal connector)
4	HPM_SL3 (signal connector on HPM)	BP_DST_PA2 (backplane signal connector)
5	HPM_SL4 (signal connector on HPM)	BP_DST_PB2 (backplane signal connector)
6	HPM_SL5 (signal connector on HPM)	BP_DST_PA1 (backplane signal connector)
7	HPM_SL6 (signal connector on HPM)	BP_DST_PB1 (backplane signal connector)
8	HPM_SL23/SL24 (signal connector on HPM)	BP_DST_PA2/PB2 (backplane signal connector)

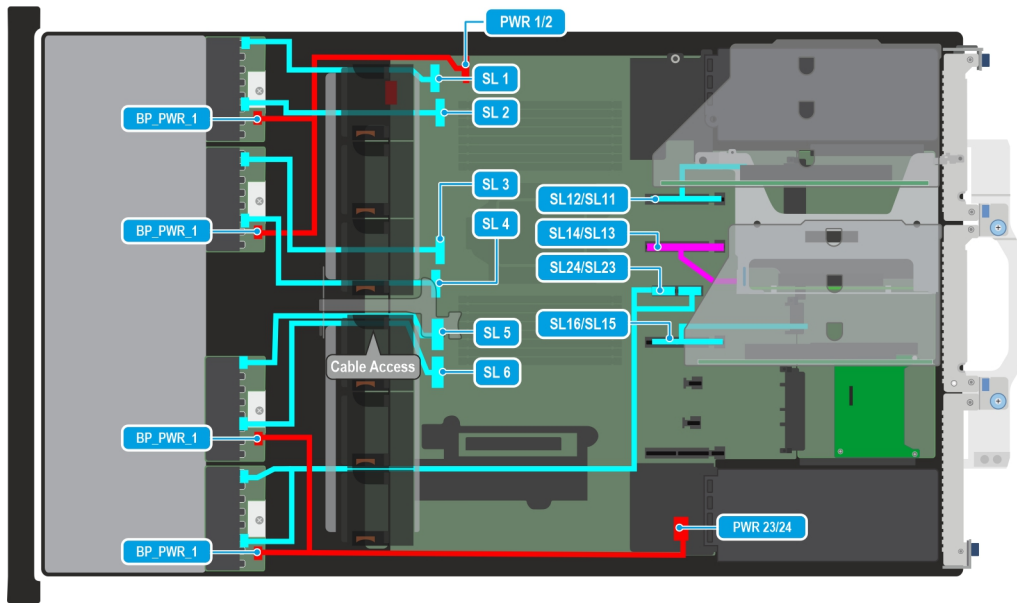

Figure 104. C07-01 Cable Config 21: 32 x EDSFF E3.S (G5x2 NVMe Direct Connect)

NOTE: Follow the sequential order as shown in the table to remove the cables, to install the cables follow the reverse sequential order.

Table 77. C07-01 Cable Config 21: 32 x EDSFF E3.S (G5x2 NVMe Direct Connect)

Order	From	To
1	HPM_PWR1/2 (power connector on HPM)	BP_PWR_1 (power connector on backplanes)
2	HPM_SL1 (signal connector on HPM)	BP_DST_PA1/PB1 (backplane signal connector)
3	HPM_SL2 (signal connector on HPM)	BP_DST_PA2/PB2 (backplane signal connector)
4	HPM_SL3 (signal connector on HPM)	BP_DST_PA1/PB1 (backplane signal connector)
5	HPM_SL4 (signal connector on HPM)	BP_DST_PA2/PB2 (backplane signal connector)
6	HPM_PWR23/24 (power connector on HPM)	BP_PWR_1 (power connector on backplanes)
7	HPM_SL5 (signal connector on HPM)	BP_DST_PA1/PB1 (backplane signal connector)
8	HPM_SL6 (signal connector on HPM)	BP_DST_PA2/PB2 (backplane signal connector)
9	HPM_SL23/24 (signal connector on HPM)	BP_DST_PA1/PB1 (backplane signal connector)
10	HPM_SL11/12 (signal connector on HPM)	R5b (Rear Riser 5b)
11	HPM_SL13/14 (signal connector on HPM)	R4b (Rear Riser 4b)
12	HPM_SL15/16 (signal connector on HPM)	R3e (Rear Riser 3e)

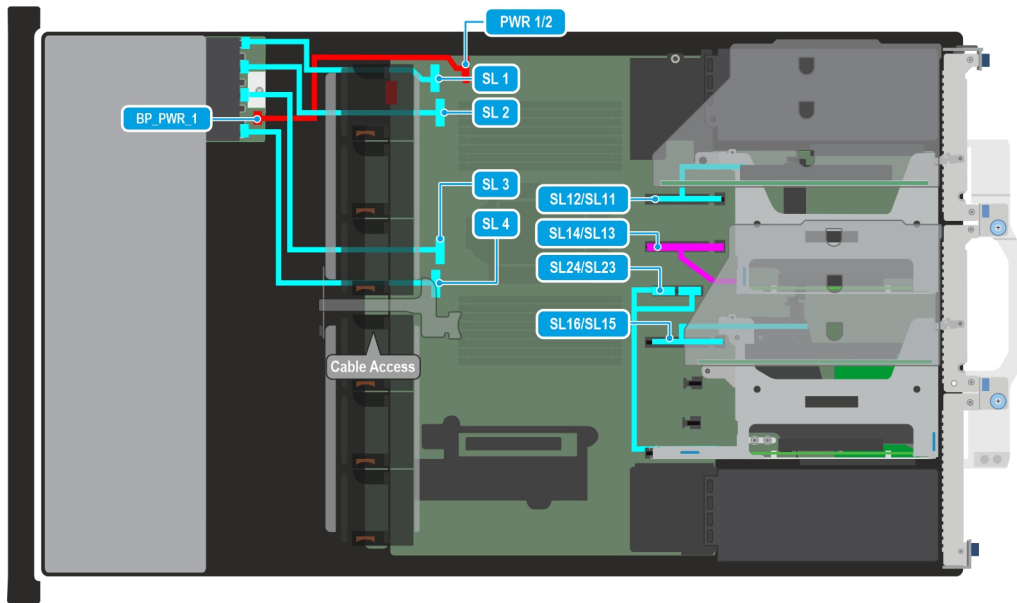

Figure 105. C08-01 Cable Config 22: 8 x EDSFF E3.S (G5x4 NVMe Direct Connect)

NOTE: Follow the sequential order as shown in the table to remove the cables, to install the cables follow the reverse sequential order.

Table 78. C08-01 Cable Config 22: 8 x EDSFF E3.S (G5x4 NVMe Direct Connect)

Order	From	To
1	HPM_PWR1/2 (power connector on HPM)	BP_PWR_1 (power connector on backplanes)
2	HPM_SL1 (signal connector on HPM)	BP_DST_PA1(backplane signal connector)
3	HPM_SL2 (signal connector on HPM)	BP_DST_PB1 (backplane signal connector)
4	HPM_SL3 (signal connector on HPM)	BP_DST_PA2 (backplane signal connector)
5	HPM_SL4 (signal connector on HPM)	BP_DST_PB2 (backplane signal connector)
6	HPM_SL11/12 (signal connector on HPM)	R5b (Rear Riser 5b)
7	HPM_SL13/14 (signal connector on HPM)	R4b (Rear Riser 4b)
8	HPM_SL15/16 (signal connector on HPM)	R3e (Rear Riser 3e)
9	HPM_SL23/24 (signal connector on HPM)	R2t (Rear Riser 32t)

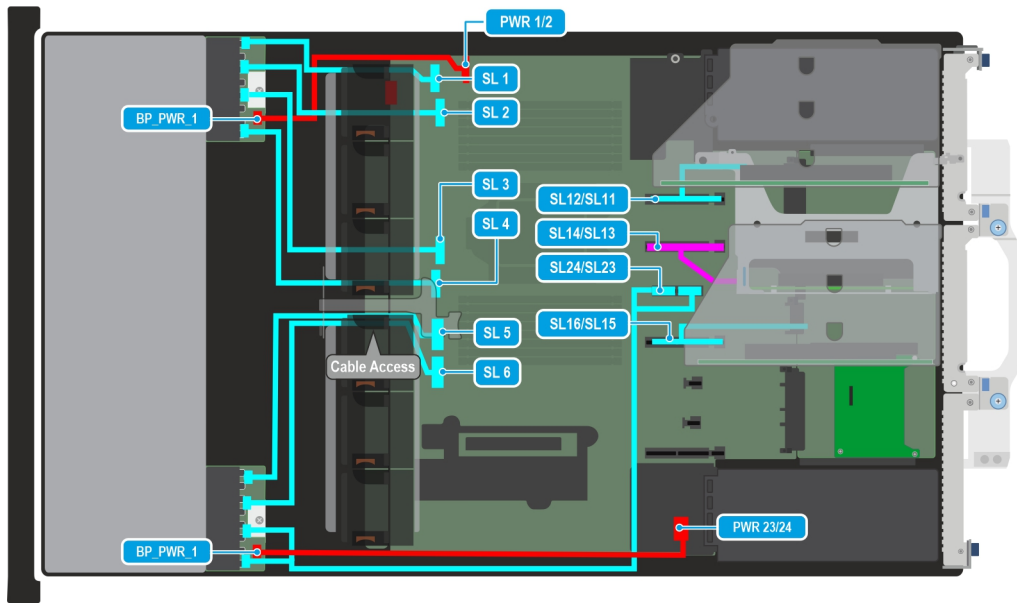

Figure 106. C09-01 Cable Config 23: 16 x EDSFF E3.S (G5x4 NVMe Direct Connect)

NOTE: Follow the sequential order as shown in the table to remove the cables, to install the cables follow the reverse sequential order.

Table 79. C09-01 Cable Config 23: 16 x EDSFF E3.S (G5x4 NVMe Direct Connect)

Order	From	To
1	HPM_PWR1/2 (power connector on HPM)	BP_PWR_1 (power connector on backplanes)
2	HPM_SL1 (signal connector on HPM)	BP_DST_PA1(backplane signal connector)
3	HPM_SL2 (signal connector on HPM)	BP_DST_PB1 (backplane signal connector)
4	HPM_SL3 (signal connector on HPM)	BP_DST_PA2 (backplane signal connector)
5	HPM_SL4 (signal connector on HPM)	BP_DST_PB2 (backplane signal connector)
5	HPM_PWR3/24 (power connector on HPM)	BP_PWR_1 (power connector on backplanes)
6	HPM_SL5 (signal connector on HPM)	BP_DST_PA1(backplane signal connector)
7	HPM_SL6 (signal connector on HPM)	BP_DST_PA2 (backplane signal connector)
8	HPM_SL23/24 (signal connector on HPM)	BP_DST_PA2/PB2 (backplane signal connector)
9	HPM_SL11/12 (signal connector on HPM)	R5b (Rear Riser 5b)
10	HPM_SL13/14 (signal connector on HPM)	R4b (Rear Riser 4b)
11	HPM_SL15/16 (signal connector on HPM)	R3e (Rear Riser 3e)

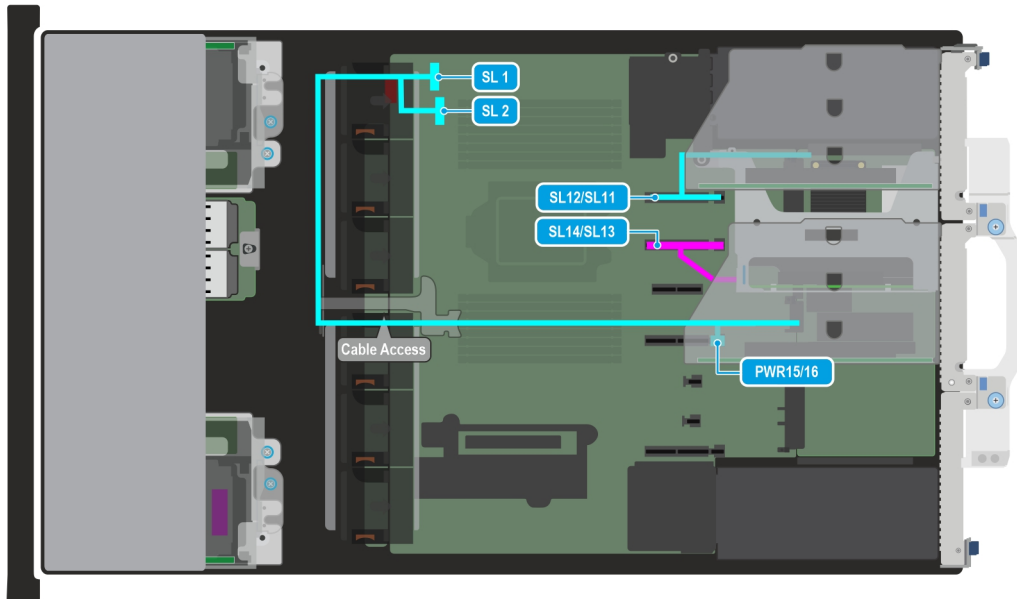

Figure 107. C00-01 Cable Config 24: No BP Config*

NOTE: Follow the sequential order as shown in the table to remove the cables, to install the cables follow the reverse sequential order.

Table 80. C00-01 Cable Config 24: No BP Config*

Order	From	To
1	HPM_SL11/SL12 (signal connector on HPM)	R5b (Rear Riser 5b)
2	HPM_SL13/SL14 (signal connector on HPM)	R4b (Rear Riser 4b)
3	HPM_SL1/SL2 (signal connector on HPM)	R3f (Riser 3f OCP)

NOTE: *Feature not available at product launch in September 2025. Please refer to the product configurator page on Dell.com to confirm feature availability.

System memory

System memory guidelines

The PowerEdge R570 system supports DDR5 registered DIMMs (RDIMMs). System memory holds the instructions that are started by the processor.

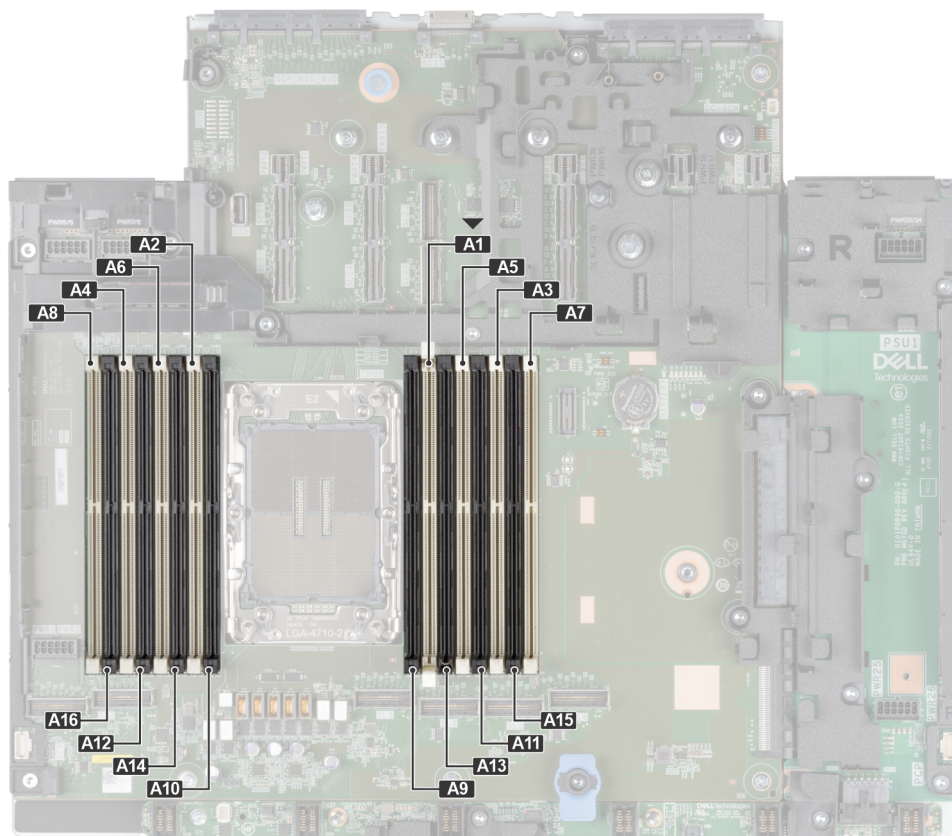

Figure 108. Memory channels

Memory channels are organized as follows:

Table 81. Memory channels

Processor	Channel A	Channel B	Channel C	Channel D	Channel E	Channel F	Channel G	Channel H
Processor 1	Slots A1 and A9	Slots A5 and A13	Slots A3 and A11	Slots A7 and A15	Slots A2 and A10	Slots A6 and A14	Slots A4 and A12	Slots A8 and A16

Table 82. Supported memory matrix

DIMM type	Rank	Capacity	DIMM rated voltage and speed	Operating Speed			
				Intel® Xeon® 6 E- core processor		Intel® Xeon® 6 P- core processor	
				1 DIMM per channel (DPC)	2 DIMM per channel (DPC)	1 DIMM per channel (DPC)	2 DIMM per channel (DPC)
RDIMM	1R	16 GB	DDR5 (1.1 V), 6400 MT/s	N/A	N/A	Up to 6400 MT/s	N/A
	2 R	32 GB	DDR5 (1.1 V), 6400 MT/s	Up to 6400 MT/s	N/A	Up to 6400 MT/s	Up to 5200 MT/s
		64 GB	DDR5 (1.1 V), 6400 MT/s	Up to 6400 MT/s	Up to 5200 MT/s	Up to 6400 MT/s	Up to 5200 MT/s
		96 GB	DDR5 (1.1 V), 6400 MT/s	N/A	N/A	Up to 6400 MT/s	Up to 5200 MT/s

Table 82. Supported memory matrix (continued)

DIMM type	Rank	Capacity	DIMM rated voltage and speed	Operating Speed			
				Intel® Xeon® 6 E- core processor		Intel® Xeon® 6 P- core processor	
				1 DIMM per channel (DPC)	2 DIMM per channel (DPC)	1 DIMM per channel (DPC)	2 DIMM per channel (DPC)
		128 GB	DDR5 (1.1 V), 6400 MT/s	N/A	N/A	Up to 6400 MT/s	Up to 5200 MT/s
	8 R	256 GB	DDR5 (1.1 V), 6400 MT/s	N/A	N/A	N/A	Up to 5200 MT/s

NOTE: The processor may reduce the performance of the rated DIMM speed.

NOTE: Maximum DIMM transfer speed support dependent on CPU SKU and DIMM population.

Table 83. Memory population guide for Intel® Xeon® 6 E- core

DIMM Capacity	1 DIMM	4 DIMMS	8 DIMMS (1DPC)	12 DIMMS	16 DIMMS (2DPC)
32 GB RDIMM	Yes	N/A	Yes	N/A	N/A
64 GB RDIMM	N/A	N/A	Yes	N/A	Yes

Table 84. Memory population guide for Intel® Xeon® 6 P- core

DIMM Capacity	1 DIMM	4 DIMMS	8 DIMMS (1DPC)	12 DIMMS	16 DIMMS (2DPC)
16 GB RDIMM	Yes	N/A	Yes	N/A	N/A
32 GB RDIMM	Yes	Yes	Yes	Yes	Yes
64 GB RDIMM	N/A	Yes	Yes	N/A	Yes
96 GB RDIMM	N/A	N/A	Yes	N/A	Yes
128 GB RDIMM	N/A	N/A	Yes	N/A	Yes
256 GB RDIMM	N/A	N/A	N/A	N/A	Yes

NOTE: Follow the memory population guide to populate the system memory appropriately with the right capacity.

NOTE: Memory mirroring and Fault Resilient Mode(FRM) are supported in 8 or 16 DIMMs per CPU configuration.

NOTE: One DIMM per CPU configuration has limited features.

General memory module installation guidelines

To ensure optimal performance of your system, observe the following general guidelines when configuring your system memory. If your system's memory configuration fails to observe these guidelines, your system might not boot, stop responding during memory configuration, or operate with reduced memory.

The memory bus may operate at speeds of 6400 MT/s or lower, speed depending on the following factors:

- System profile selected (for example, Performance, Performance Per Watt Optimized (OS), or Custom [can be run at high speed or lower])
- Maximum supported DIMM speed of the processors
- Only DDR5 - 6400 MT/s RDIMMs are supported

 **NOTE:** MT/s indicates DIMM speed in Mega-Transfers per second.

The following are the recommended guidelines for installing memory modules:

- All DIMMs must be DDR5.
- DIMM mixing configurations are not supported. All DIMM slots must be populated with the exact same DIMMs.
- Populate memory module sockets only if a processor is installed.
- For single-processor systems, sockets A1 to A16 are available.

In **Optimizer Mode**, the DRAM controllers operate independently in the 64-bit mode and provide optimized memory performance.

Table 85. Memory population rules

Processor	Memory population	Memory population information
Single processor	A{1}, A{2}, A{3}, A{4}, A{5}, A{6}, A{7}, A{8}, A{9}, A{10}, A{11}, A{12}, A{13}, A{14}, A{15}, A{16}	1, 4, 8, 12 or 16 DIMMs are allowed.

- Populate all the sockets with white release tabs first, followed by the sockets with black release tabs.
- Unbalanced or odd memory configurations result in a performance loss, and the system may not identify the memory modules being installed. Always populate memory channels identically with equal DIMMs for the best performance.
- Supported RDIMM configurations are 1, 4, 8, 12 or 16 DIMMs per processor.
- The RDIMM configuration depends on the DIMM capacity and the processor combination. Refer the [System memory guidelines](#) for more information.

Removing a memory module

Prerequisites

1. Follow the safety guidelines listed in the [Safety instructions](#).
2. Follow the procedure listed in [Before working inside your system](#).
3. [Remove the system cover](#).
4. [Remove the air shroud](#).

 **WARNING:** The memory modules are hot to touch for some time after the system has been powered off. Allow the memory modules to cool before handling them.

 **NOTE:** For proper system cooling, memory module blanks must be installed in any memory socket that is not populated. Remove the memory module blanks only if you intend to install the memory module in these sockets. DIMM blanks are only required when the CPU TDP is greater than 250 W. CPU with TDP less than 250 W do not require DIMM blanks.

Steps

1. Locate the appropriate memory module socket.
2. To release the memory module from the socket, simultaneously press the ejectors on both ends of the memory module socket to fully open.

 **CAUTION:** Handle each memory module only by the card edges, ensuring not to touch the middle of the memory module or metallic contacts.

3. Lift the memory module away from the system.

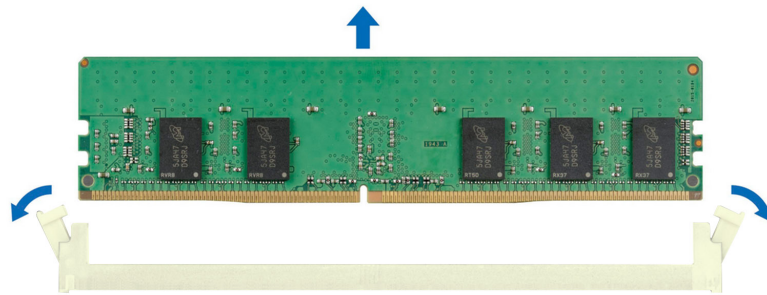

Figure 109. Removing a memory module

4. If a winged type heat sink is installed, follow step 1 and step 2. Lift the memory module at an angle away from the system.

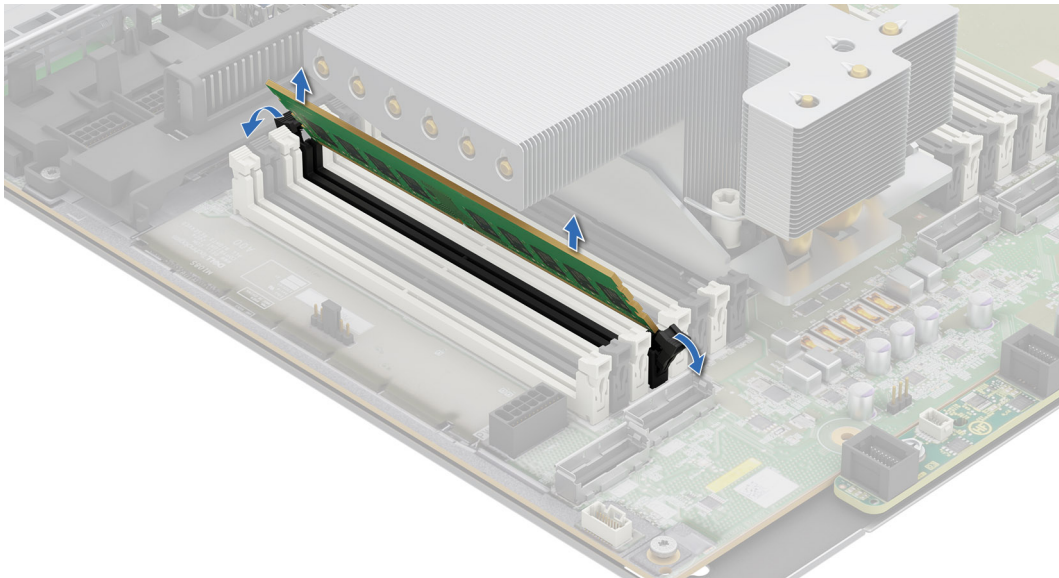

Figure 110. Removing a memory module under the winged type heat sink

Next steps

Replace the memory module.

Installing a memory module

Prerequisites

1. Follow the safety guidelines listed in the [Safety instructions](#).
2. Follow the procedure listed in [Before working inside your system](#).
3. [Remove the system cover](#).
4. [Remove the air shroud](#).

Steps

1. Locate the appropriate memory module socket.

CAUTION: Handle each memory module only by the card edges, ensuring not to touch the middle of the memory module or metallic contacts.

NOTE: Ensure that the socket ejector latches are fully open before installing the memory module.

2. Align the edge connector of the memory module with the alignment key of the memory module socket, and insert the memory module in the socket.

CAUTION: To prevent damage to the memory module or the memory module socket during installation, do not bend or flex the memory module. Insert both ends of the memory module simultaneously.

NOTE: The memory module socket has an alignment key that enables you to install the memory module in the socket in only one orientation.

CAUTION: Do not apply pressure at the center of the memory module; apply pressure at both ends of the memory module evenly.

3. Press the memory module with your thumbs until the ejectors firmly click into place. When the memory module is properly seated in the socket, the memory module socket levers align with the levers on the other sockets that have memory modules that are installed.

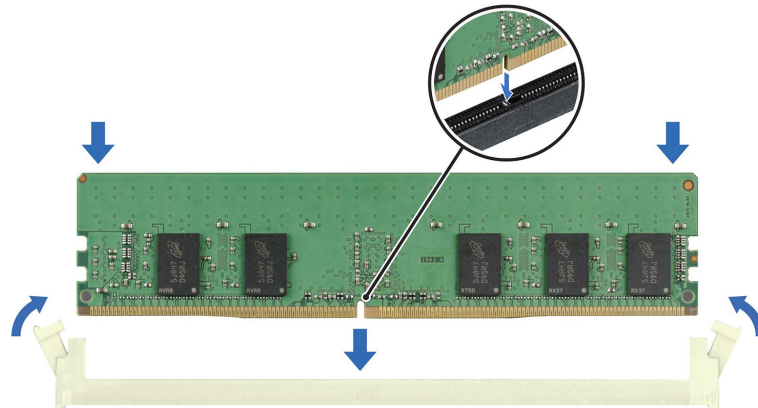

Figure 111. Installing a memory module

4. If a winged type heat sink is installed, insert the memory module into the socket at an angle under the heat sink. Press the memory module with your thumbs until the ejectors firmly click into place.

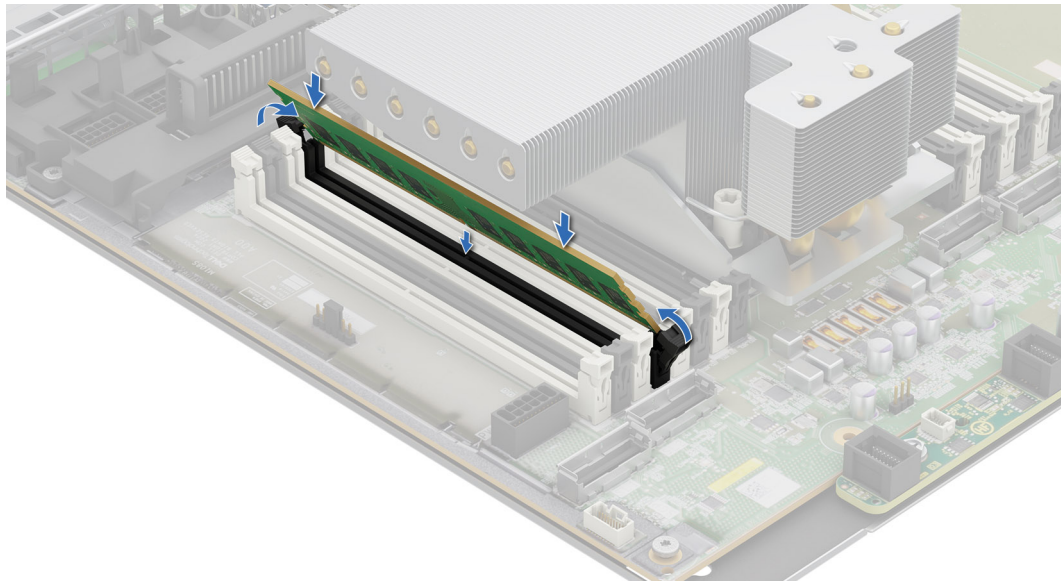

Figure 112. Installing a memory module under the winged type heat sink

Next steps

1. [Install the air shroud.](#)
2. [Install the system cover.](#)
3. Follow the procedure listed in [After working inside your system.](#)
4. To verify that the memory module has been installed properly, press **F2** during reboot and click **System Setup Main Menu > System BIOS > Memory Settings**. In the **Memory Settings** screen, the **System Memory Size** must reflect the updated capacity of the installed memory.
5. If the **System Memory Size** is incorrect, one or more of the memory modules may not be installed properly. Shut down the system and ensure that the memory modules are firmly seated in the correct sockets.
6. Run the system memory test in system diagnostics.

Processor and heat sink

This is a service technician replaceable part only.

Removing the processor and heat sink module

Prerequisites

1. Follow the safety guidelines listed in the [Safety instructions.](#)
2. Follow the procedure listed in the [Before working inside your system.](#)
3. [Remove the system cover.](#)
4. [Remove the air shroud.](#)
5. The system supports different types of heatsinks and the procedure to remove them are similar.

NOTE: The heat sink and processor are hot to touch for some time after the system has been powered off. Allow the heat sink and processor to cool down before handling them.

Steps

1. Ensure all four anti-tilt wires are in the locked position (outward position), and then using a Torx T30 screwdriver, loosen the captive nuts on the processor heat sink module (PHM) in the order that is mentioned below:
 - a. Loosen the first nut three turns.
 - b. Loosen the nut diagonally opposite to the nut you loosened first.

- c. Repeat the procedure for the remaining two nuts.
- d. Return to the first nut and loosen it completely.

i **NOTE:** Ensure that the anti-tilt wires on the PHM are in locked position when loosening the captive nuts.

- 2. Set all the anti-tilt wires to unlocked position (inward position).

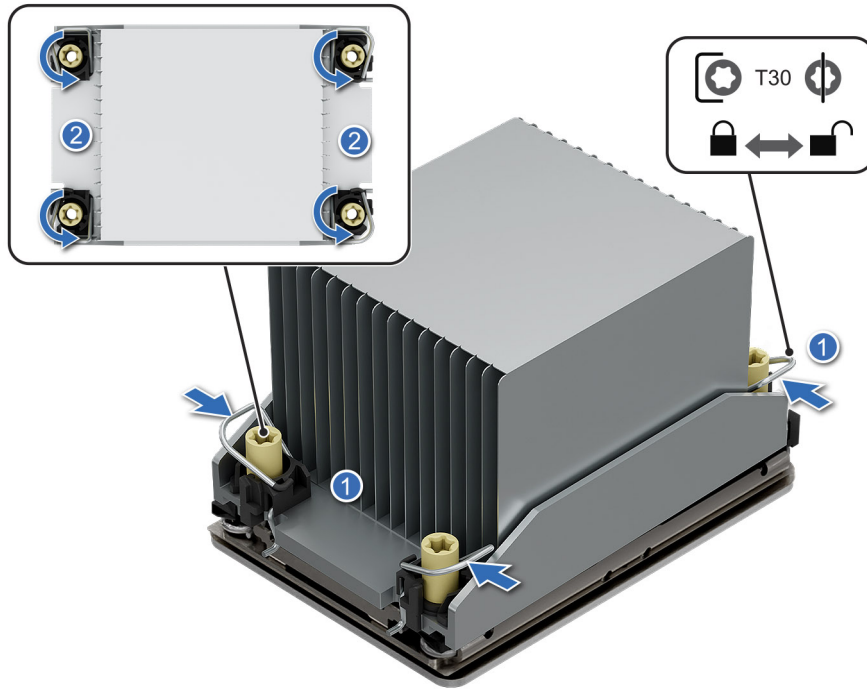

Figure 113. Removing the processor heat sink module

- 3. Lift the PHM from the system and set the PHM aside with the processor side facing up.

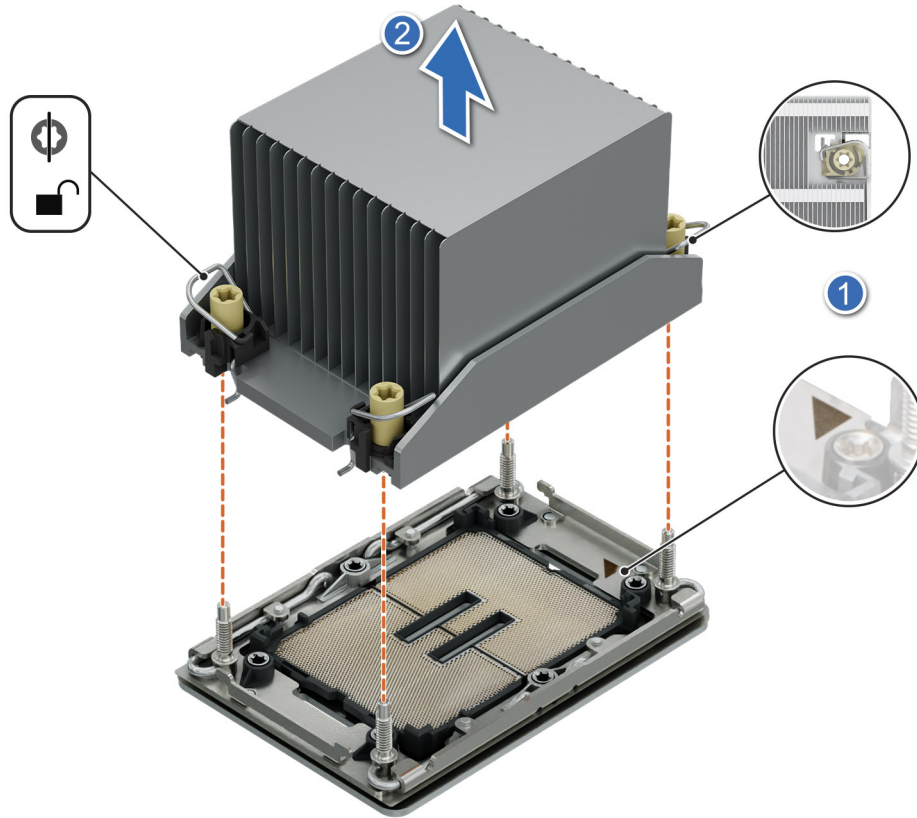

Figure 114. Removing a heat sink

Next steps

If you are removing a faulty heat sink, then [replace the heat sink](#), if not, [remove the processor](#).

Removing the processor

Prerequisites

⚠ WARNING: Remove the processor from processor and heat sink module (PHM) only if you are replacing the processor or heat sink.

1. Follow the safety guidelines listed in the [Safety instructions](#).
2. Follow the procedure listed in the [Before working inside your system](#).
3. [Remove the processor heat sink module](#).

⚠ CAUTION: You may find the CMOS battery loss or CMOS checksum error that is displayed during the first instance of powering on the system after the processor or system board replacement which is expected. To fix this, go to setup option to configure the system settings.

Steps

1. Place the heat sink with the processor side facing up.
2. Using your thumb, lift the thermal interface material (TIM) break lever to release the processor from the TIM and retaining clip.
3. Holding the processor by the edge, lift the processor away from the retaining clip.

ⓘ NOTE: Ensure to hold the retaining clip to the heat sink as you lift the TIM break lever.

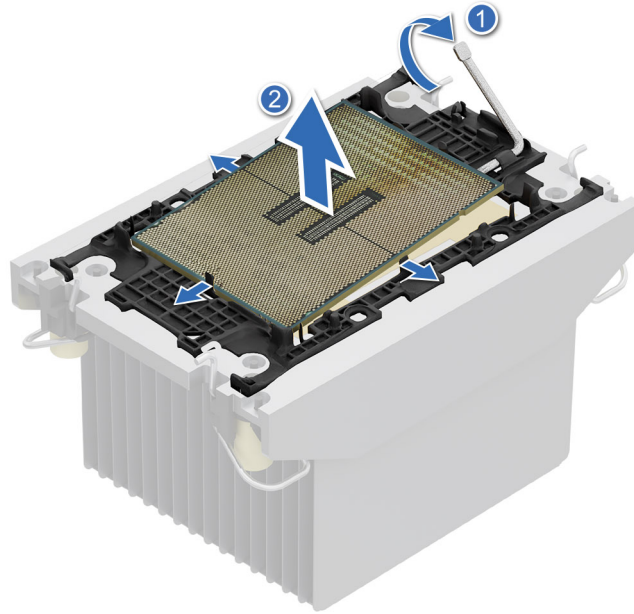

Figure 115. Removing the processor

NOTE: Ensure to return the TIM break lever on the retaining clip back to its original position.

4. Using your thumb and index finger, first hold the retaining clip release tab at the pin 1 connector, pull out the tip of the retaining clip release tab, and then lift the retaining clip partially from the heat sink.
5. Repeat the procedure at the remaining three corners of the retaining clip.
6. After all the corners are released from the heat sink, lift the retaining clip from the pin 1 corner of the heat sink.

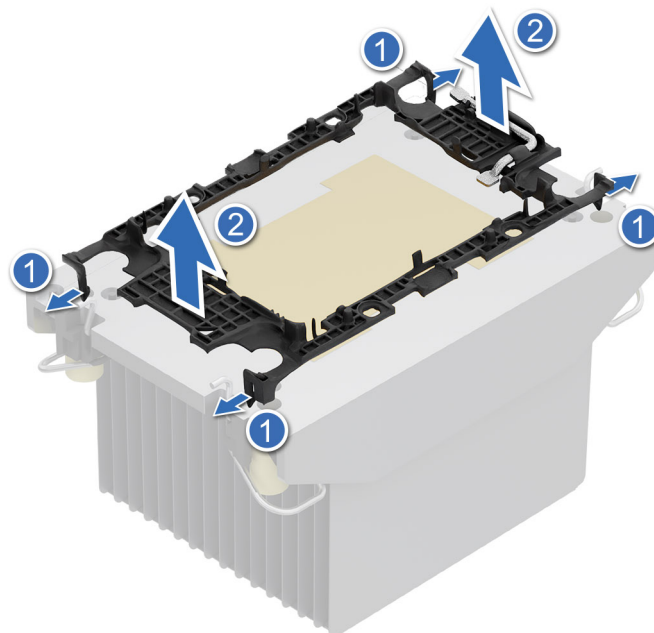

Figure 116. Removing the retaining clip

Next steps

Replace the processor.

Installing the processor

Prerequisites

1. Follow the safety guidelines listed in the [Safety instructions](#).
2. Follow the procedure listed in the [Before working inside your system](#).
3. [Remove the processor heat sink module](#).

Steps

1. Place the processor in the processor tray.

i **NOTE:** Ensure the pin 1 indicator on the processor tray is aligned with the pin 1 indicator on the processor.

2. Place the retaining clip on top of the processor in the processor tray, aligning pin 1 indicator on the processor.

i **NOTE:** Ensure the pin 1 indicator on the retaining clip is aligned with the pin 1 indicator on the processor before placing the retaining clip on the processor.

i **NOTE:** Before you install the heat sink, ensure to place the processor and retaining clip in the tray.

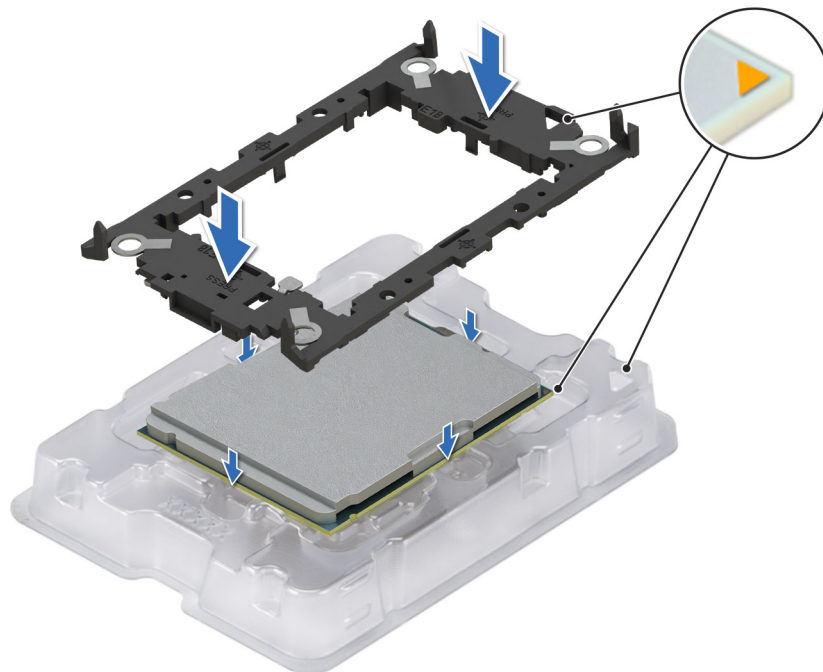

Figure 117. Installing the retaining clip

3. Align the processor with a retaining clip, by using your fingers press the retaining clip on all the four sides until it clicks into place.

i **NOTE:** Ensure that the processor is securely latched to the retaining clip.

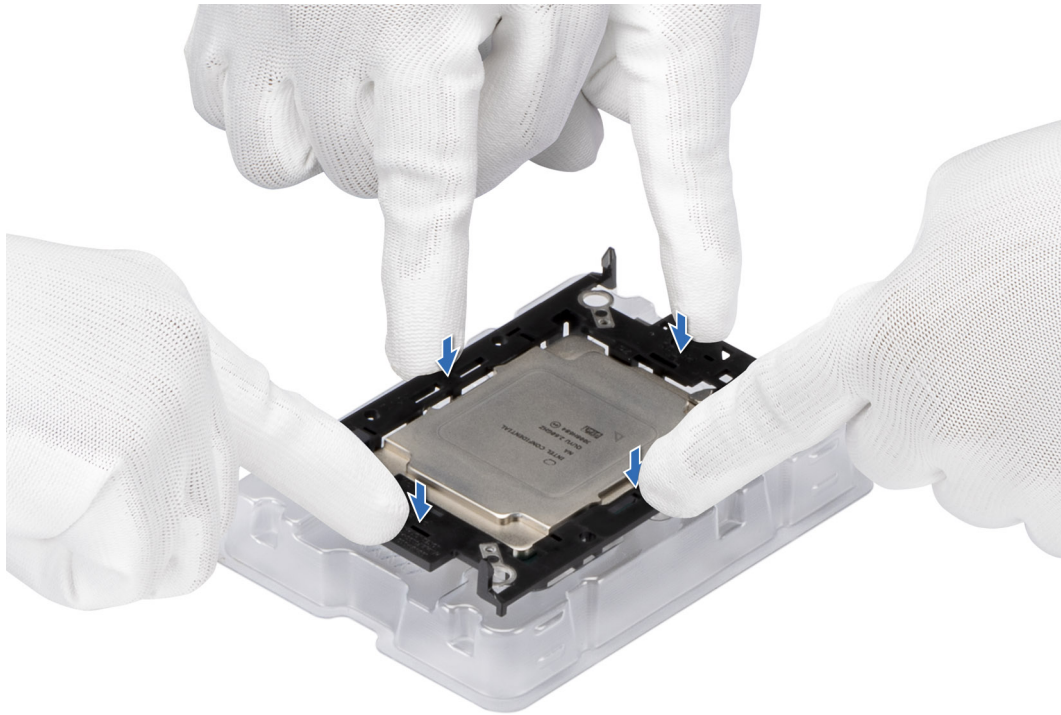

Figure 118. Press the retaining clip on the four sides

4. If you are using an existing heat sink, remove the thermal grease from the heat sink by using a clean lint-free cloth.
5. Apply the thermal grease in a thin spiral design on the bottom of the heat sink.

CAUTION: Applying too much thermal grease can result in excess grease coming in contact with and contaminating the processor socket.

NOTE: The thermal grease syringe is intended for single use only. Dispose the syringe after you use it.

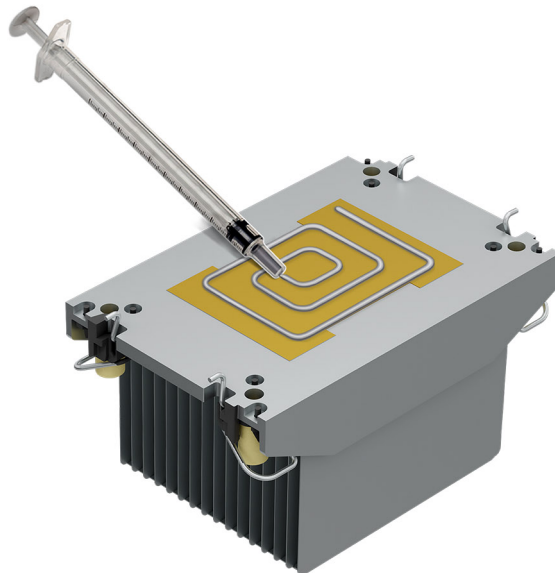

Figure 119. Applying thermal grease

6. For a new heat sink, pull and remove the plastic cover from the base of the heat sink.

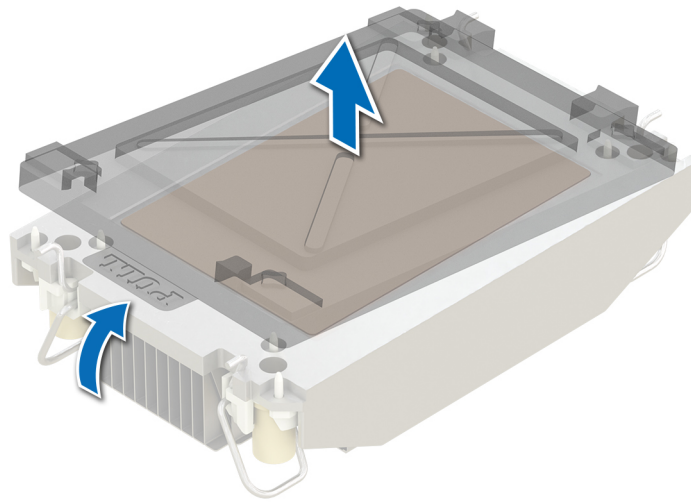

Figure 120. Removing the cover

7. Place the heat sink on the processor and press the base of the heat sink until the retaining clip locks onto the heat sink at all the four corners.

CAUTION: To avoid damaging the fins on the heat sink, do not press down on the heat sink fins.

NOTE:

- Ensure latching features on retaining clip, and heat sink are aligned during assembly.
- Ensure that the pin 1 indicator on the heat sink is aligned with the pin 1 indicator on the retaining clip before placing the heat sink onto the retaining clip.

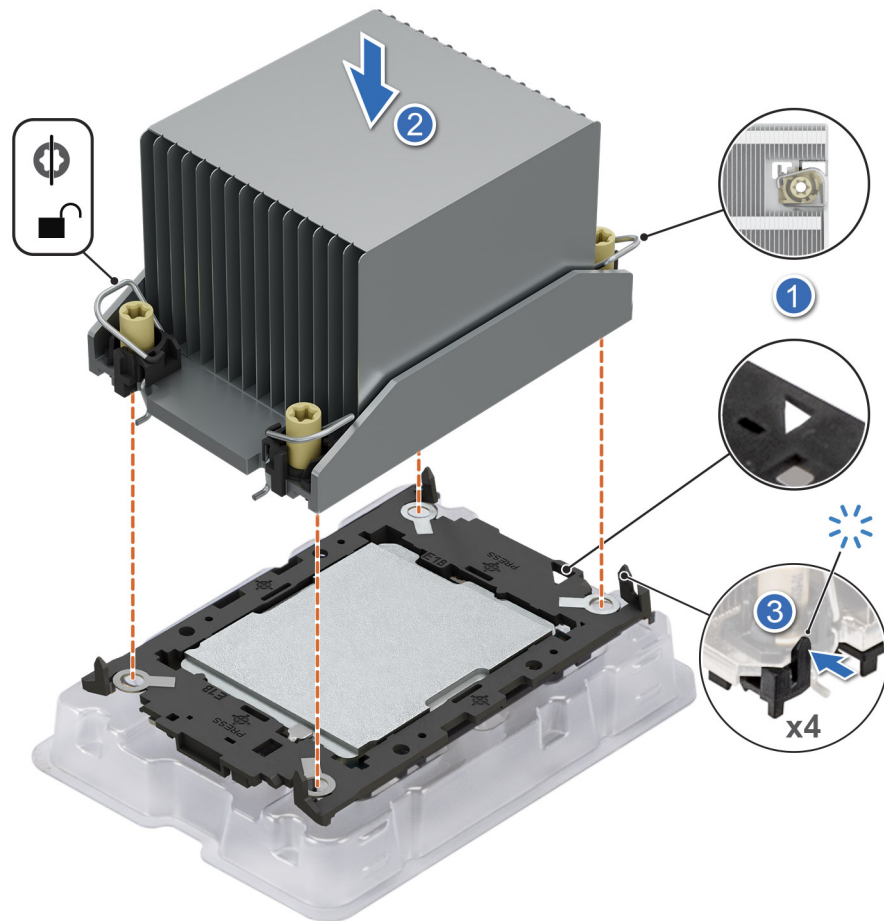

Figure 121. Installing the heat sink onto the processor

Next steps

1. Install the processor heat sink module.
2. Follow the procedure listed in [After working inside your system](#).

Installing the processor and heat sink module

Prerequisites

1. Follow the safety guidelines listed in the [Safety instructions](#).
2. Follow the procedure listed in the [Before working inside your system](#).
3. [Remove the system cover](#).
4. [Remove the air shroud](#).
5. The system supports different types of heatsinks and the procedure to install them are similar.

NOTE: The heat sink and processor are hot to touch for some time after the system has been powered off. Allow the heat sink and processor to cool down before handling them.

Steps

1. Set the anti-tilt wires to the unlocked position on the heat sink (inward position).
2. Align the pin 1 indicator of the heat sink to the HPM board, and then place the processor heat sink module (PHM) on the processor socket.

CAUTION: To avoid damaging the fins on the heat sink, do not press down on the heat sink fins.

NOTE: Ensure that the PHM is held parallel to the HPM board to prevent damaging the components.

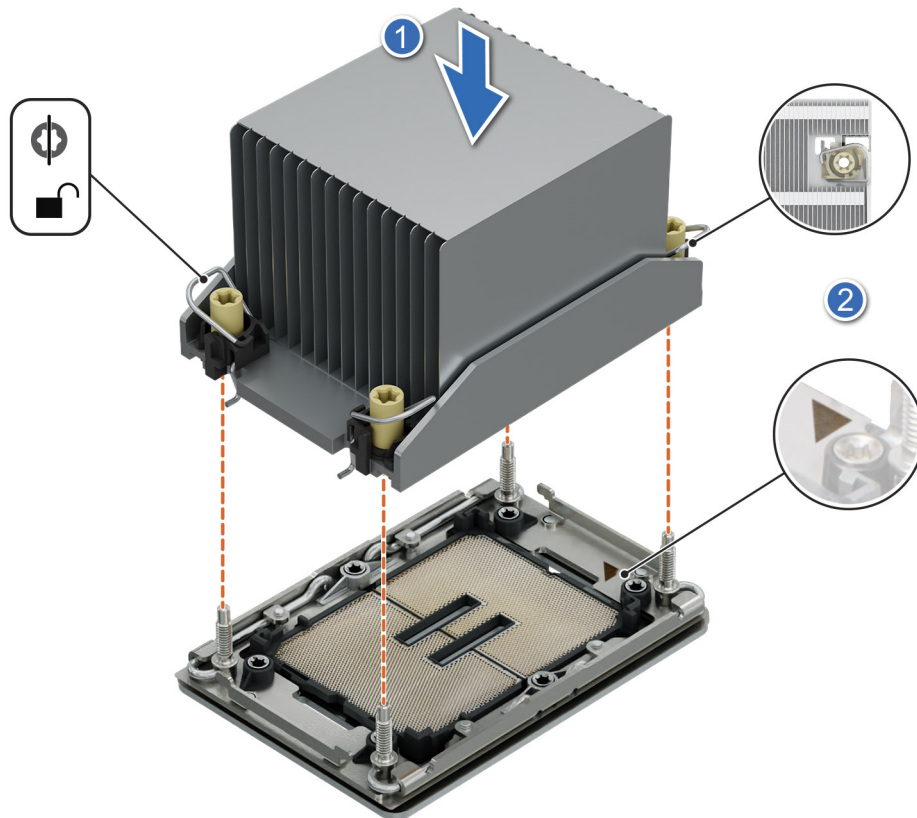

Figure 122. Installing the processor heat sink

3. Set the anti-tilt wires to the locked position (outward position), and then using the Torx T30 screwdriver, tighten the captive nuts (8 in-lbf) on the heat sink in the order below or as shown on the heatsink module:
 - a. In a random order, tighten the first nut three turns.
 - b. Tighten the nut diagonally opposite to the nut that you tighten first.
 - c. Repeat the procedure for the remaining two nuts.
 - d. Return to the first nut to tighten it completely.
 - e. Check all the nuts to ensure that they are firmly secured.

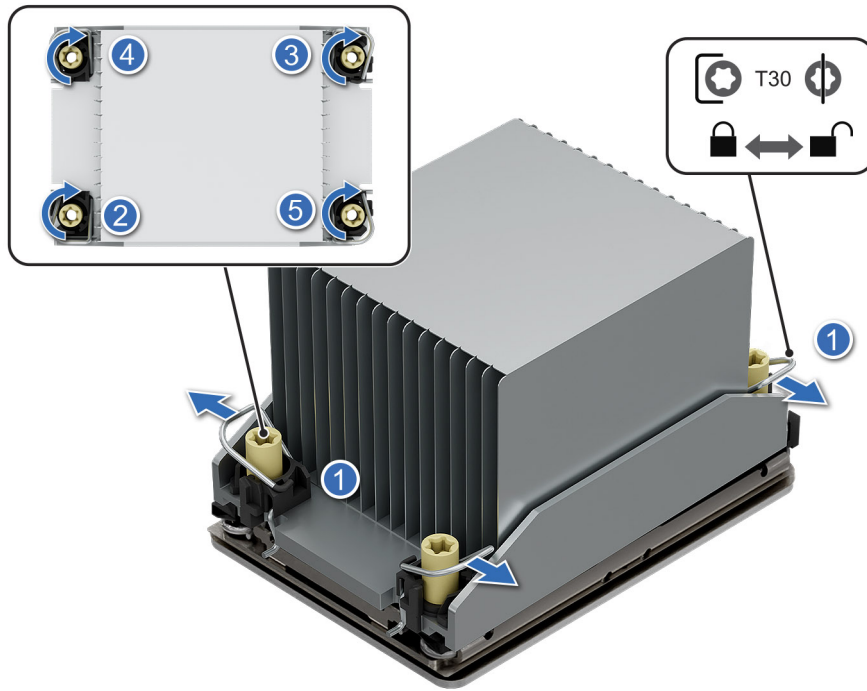

Figure 123. Set the anti-tilt wires to the locked position and tightening the nuts

Next steps

1. Install the air shroud.
2. Install the system cover.
3. Follow the procedure listed in the [After working inside your system](#).

PERC cards

Removing the fPERC module

Prerequisites

1. Follow the safety guidelines listed in the [Safety instructions](#).
2. Follow the procedure listed in the [Before working inside your system](#).
3. [Remove the front bezel](#).
4. [Remove the system cover](#).
5. [Remove the air shroud](#).
6. [Remove the drive backplane cover](#).
7. Disconnect the power cable and other required cables, observe the cable routing.

NOTE: See [cable routing](#) section.

Steps

1. Loosen the captive screws to disengage the fPERC module.
2. Slide the fPERC module towards the right of the system and lift it from the system.

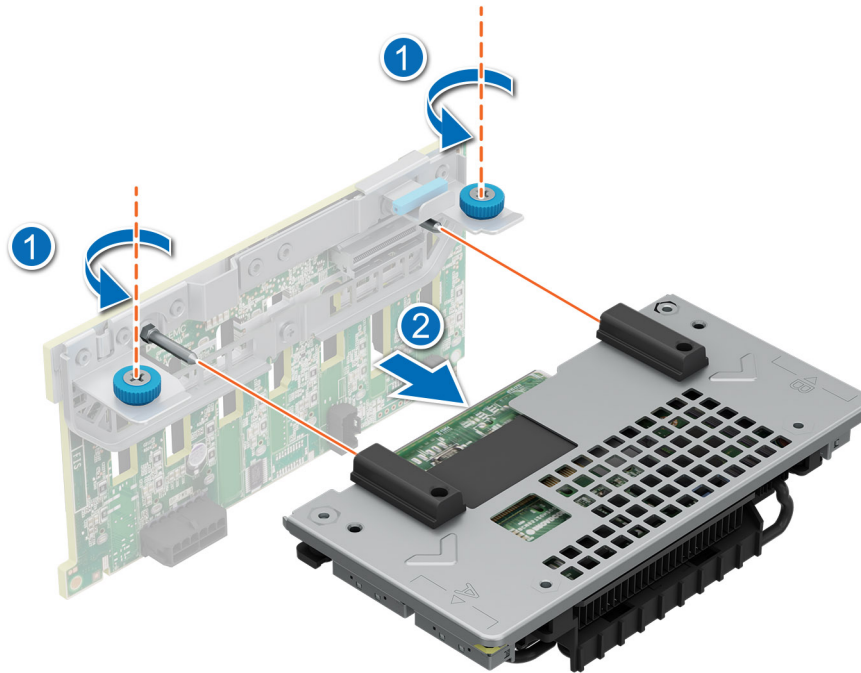

Figure 124. Removing the fPerc module

Next steps

1. [Replace the fPERC module.](#)

Installing the fPERC module

Prerequisites

1. Follow the safety guidelines listed in the [Safety instructions](#).
2. Follow the procedure listed in the [Before working inside your system](#).
3. [Remove the front bezel.](#)
4. [Remove the system cover.](#)
5. [Remove the air shroud.](#)
6. [Remove the drive backplane cover.](#)
7. Disconnect the power cable and other required cables, observe the cable routing.

NOTE: See [cable routing](#) section.

Steps

1. Insert the fPERC module long the guide pins and place it flat when it is below the backplane connectors.
2. Tighten the captive screws to secure the PERC module.

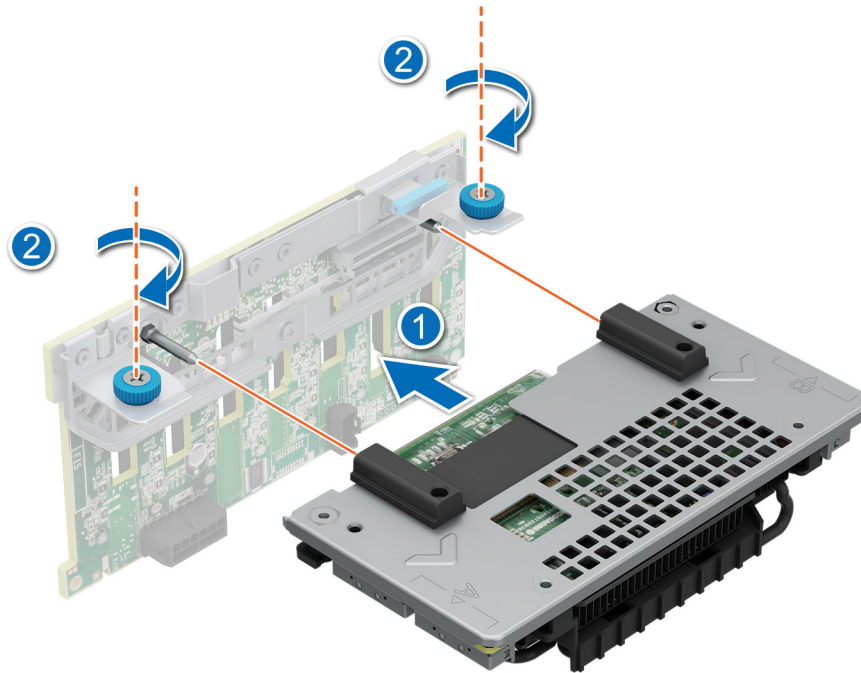

Figure 125. Installing the fPERC module

Next steps

1. Connect all the cables, and ensure that all the cables are routed through the respective cable clip.

NOTE: See [cable routing](#) section.

2. Install the drive backplane cover.
3. Install the air shroud.
4. Install the system cover.
5. Follow the procedure listed in [After working inside your system](#).

Expansion cards and expansion card risers

NOTE: When an expansion card is not supported or missing, the iDRAC logs an event. This does not prevent your system from booting. However, if a F1/F2 pause occurs with an error message, see **Troubleshooting expansion cards section** in the **PowerEdge Servers Troubleshooting Guide** at [PowerEdge manuals](#).

Expansion card installation guidelines

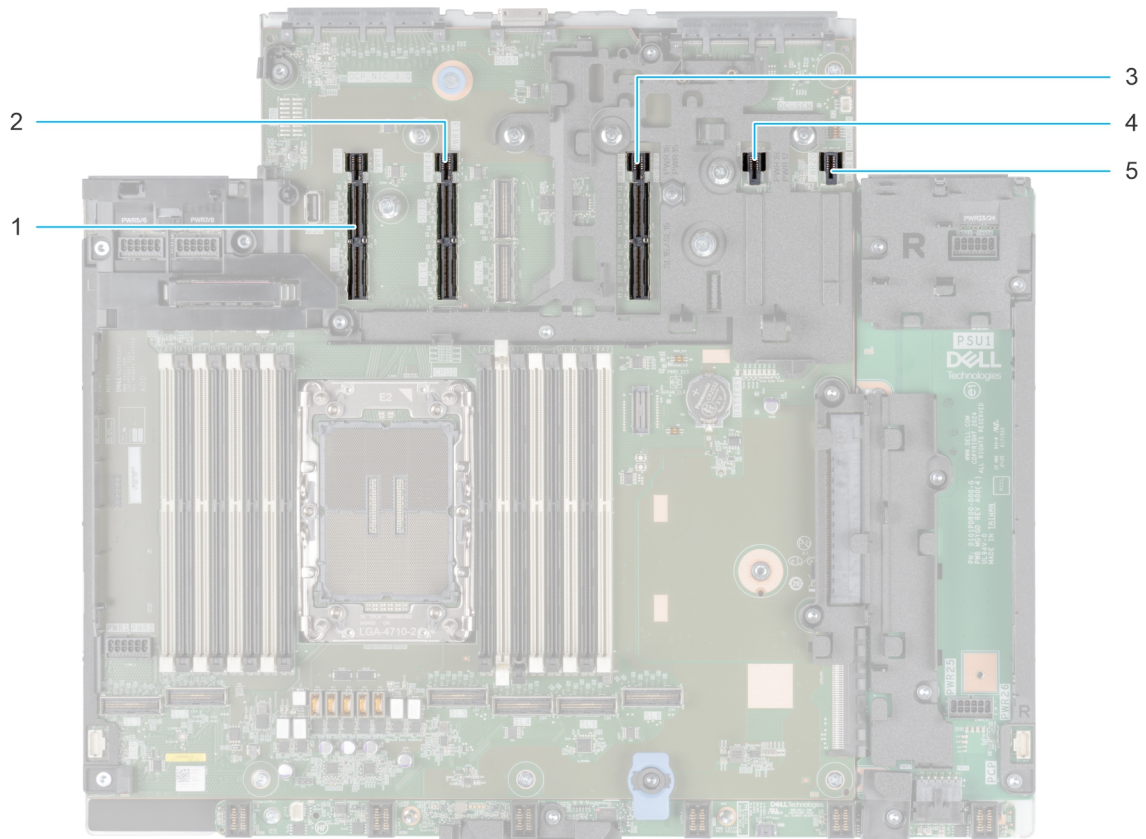

Figure 126. Expansion card riser slot connectors

- 1. Riser 5
- 2. Riser 4
- 3. Riser 3
- 4. Riser power connector
- 5. Riser power connector

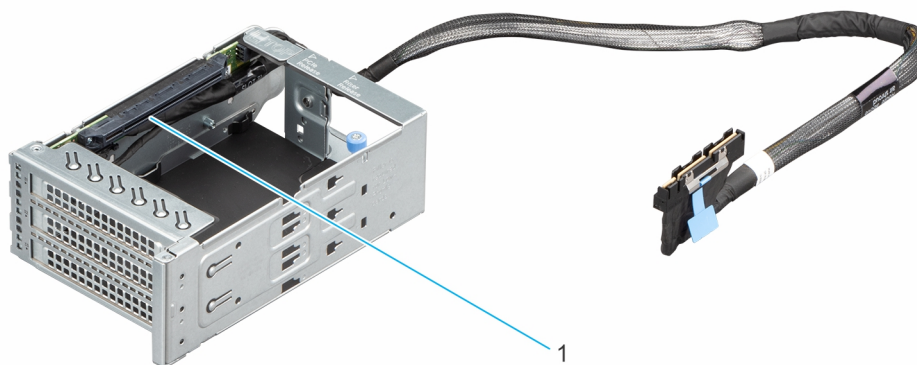

Figure 127. Riser RF1

- 1. Slot 3

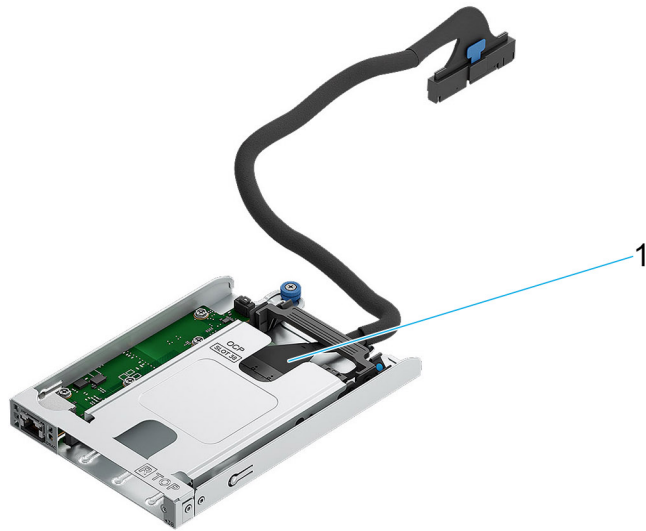

Figure 128. Riser RF2

1. Slot 34

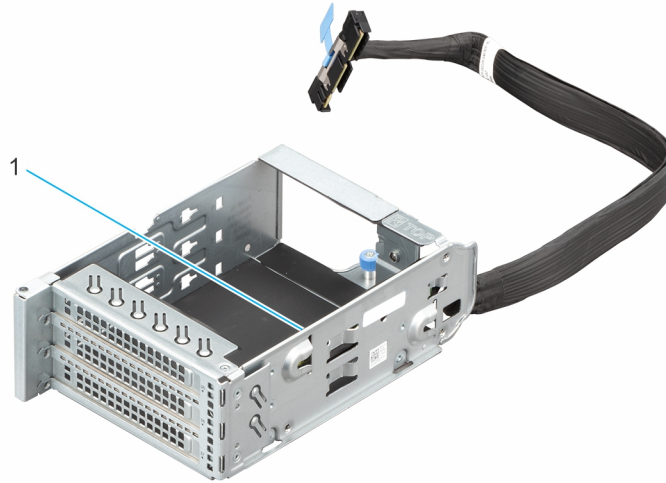

Figure 129. Riser RF3

1. Slot 36

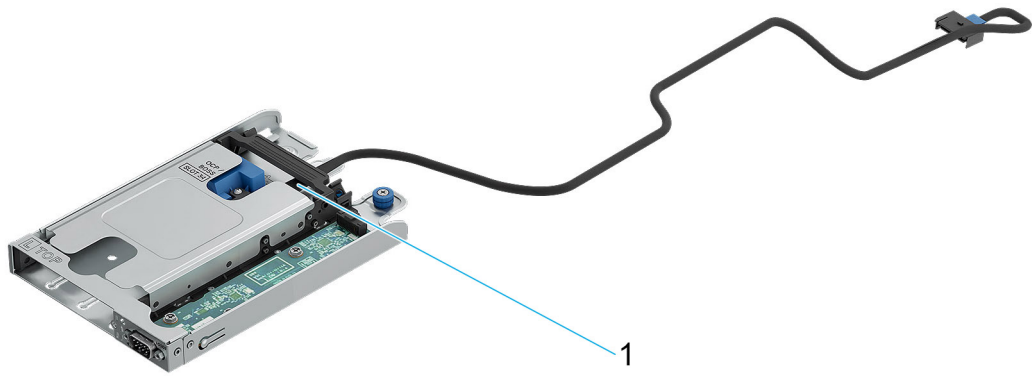

Figure 130. Riser RF4

1. Slot 38

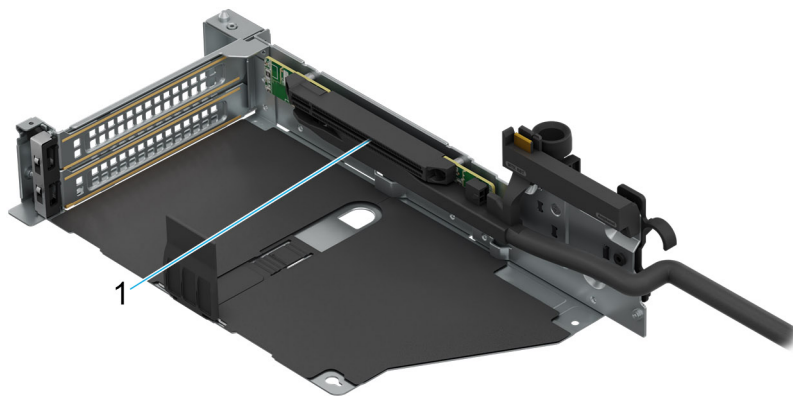

Figure 131. Riser R1

1. Slot 2

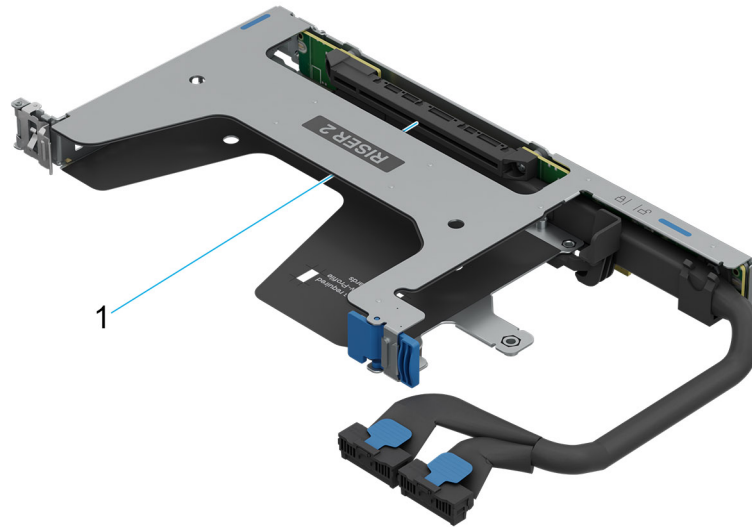

Figure 132. Riser R2

1. Slot 3

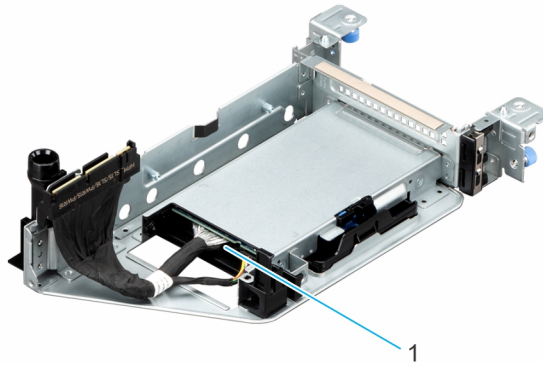

Figure 133. Riser R3

1. Slot 4

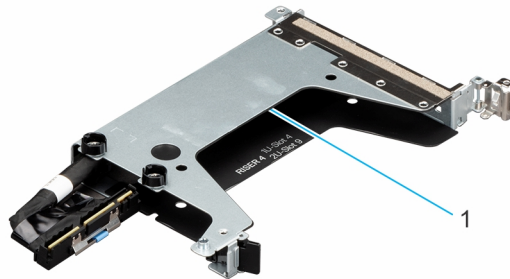

Figure 134. Riser R4

1. Slot 9

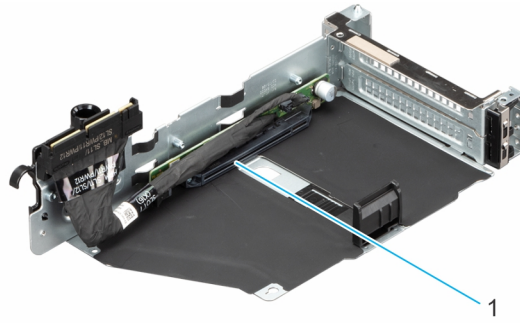

Figure 135. Riser R5

1. Slot 7

NOTE: The expansion-card slots are not hot-swappable.

The following table provides guidelines for installing expansion cards to ensure proper cooling and mechanical fit. The expansion cards with the highest priority should be installed first using the slot priority indicated. All the other expansion cards should be installed in the card priority and slot priority order.

Table 86. Expansion card riser configurations

Riser Configurations (RC)	Riser/OCP/BOSS	PCIe Slots	Form Factor	Controlling processor	Slot's Electrical Bandwidth/ Physical Connector
RC0 - Rear: 1 x16 Onboard OCP + x4 Optional BOSS	BOSS (Optional)	6	BOSS	Processor 0	PCIe Gen4 x4 (1C connector)
	Onboard OCP (Optional)	10	OCP	Processor 0	PCIe Gen5 x16 (OCP 4C+ connector)
RC1 - Rear: 4 x 16 FH(G5) + 1 x16 FLOP OCP+ 1 x16 Onboard OCP + x4 Optional BOSS	R1x	2	Full Height	Processor 0	PCIe Gen5 x16 (x16 connector)
	R2t	3	Full Height	Processor 0	PCIe Gen5 x16 (x16 connector)
	R3e	4	OCP	Processor 0	PCIe Gen5 x16 (OCP 4C+ connector)
	R4b	9	Full Height	Processor 0	PCIe Gen5 x16 (x16 connector)
	R5b	7	Full Height	Processor 0	PCIe Gen5 x16 (x16 connector)
	BOSS (Optional)	6	BOSS	Processor 0	PCIe Gen4 x4 (1C connector)
	Onboard OCP (Optional)	10	OCP	Processor 0	PCIe Gen5 x16 (OCP 4C+ connector)
RC2 - Front: 2 x16 FLOP OCP Rear: x4 Optional BOSS	RF2a	34	OCP	Processor 0	PCIe Gen5 x16 (OCP 4C+ connector)
	RF4b	38	OCP	Processor 0	PCIe Gen5 x16 (OCP 4C+ connector)
	BOSS (Optional)	6	BOSS	Processor 0	PCIe Gen4 x4 (1C connector)

Table 86. Expansion card riser configurations (continued)

Riser Configurations (RC)	Riser/OCP/BOSS	PCIe Slots	Form Factor	Controlling processor	Slot's Electrical Bandwidth/ Physical Connector
RC 3 - Front: 2 x16 FH(G5)+ x4 Optional BOSS	RF1a	31	Full Height	Processor 0	PCIe Gen5 x16 (x16 connector)
	RF3c	36	Full Height	Processor 0	PCIe Gen5 x16 (x16 connector)
	BOSS (Optional)	34	BOSS	Processor 0	PCIe Gen4 x4 (1C connector)
RC4: Front: 2 x16 FH(G5) + 2 x16 FLOP OCP +:x4 Optional BOSS	RF1a	31	Full Height	Processor 0	PCIe Gen5 x16 (x16 connector)
	RF3d	36	Full Height	Processor 0	PCIe Gen5 x16 (x16 connector)
	RF2a	34	FLOP OCP (Optional)	Processor 0	PCIe Gen5 x16 (OCP 4C+ connector)
	RF4a	38	FLOP OCP (Optional)	Processor 0	PCIe Gen5 x16 (OCP 4C+ connector)
	BOSS (Optional)	6	BOSS	Processor 0	PCIe Gen4 x4 (1C connector)
RC 5 - Rear: 1 x16 FLOP OCP + 2 x16 FH(G5) + 1 x16 Onboard OCP + x4 Optional BOSS	R3f	4	OCP	Processor 0	PCIe Gen5 x16 (OCP 4C+ connector)
	R4b	9	Full Height	Processor 0	PCIe Gen5 x16 (x16 connector)
	R5b	7	Full Height	Processor 0	PCIe Gen5 x16 (x16 connector)
	BOSS (Optional)	6	BOSS	Processor 0	PCIe Gen4 x4 (1C connector)
	Onboard OCP (Optional)	10	OCP	Processor 0	PCIe Gen5 x16 (OCP 4C+ connector)
RC 6 - 1 x16 Onboard OCP + 1x16FH(G5) + 3 x16DWFL(G5) + x4 Optional BOSS	Onboard OCP (Optional)	10	OCP	Processor 0	PCIe Gen5 x16 (OCP 4C+ connector)
	BOSS (Optional)	6	BOSS	Processor 0	PCIe Gen4 x4 (1C connector)
	R4b	9	Full Height	Processor 0	PCIe Gen5 x16 (x16 connector)
	R1x	2	Full Height	Processor 0	PCIe Gen5 x16 (x16 connector)
	R3b	4	Full Height	Processor 0	PCIe Gen5 x16 (x16 connector)
	R5b	7	Full Height	Processor 0	PCIe Gen5 x16 (x16 connector)
RC 7 - Rear: 1 x16 Onboard OCP + 1 x16 FLOP OCP +	R3f	4	OCP	Processor 0	PCIe Gen5 x16 (OCP 4C+ connector)

Table 86. Expansion card riser configurations (continued)

Riser Configurations (RC)	Riser/OCP/BOSS	PCIe Slots	Form Factor	Controlling processor	Slot's Electrical Bandwidth/ Physical Connector
2 x16 FH (G5) + 4xE3.s(G5x4) + x4 Optional BOSS	R4b	9	Full Height	Processor 0	PCIe Gen5 x16 (x16 connector)
	R5b	7	Full Height	Processor 0	PCIe Gen5 x16 (x16 connector)
	BOSS (Optional)	6	BOSS	Processor 0	PCIe Gen4 x4 (1C connector)
	Onboard OCP (Optional)	10	OCP	Processor 0	PCIe Gen5 x16 (OCP 4C+ connector)
RC 8 - Front: 1 x16 FH(G5) + 1 x16 FLOP OCP + x4 Optional BOSS + 1x16FH(G5) + 2x16DWFL(G5)	RF1a	31	Full Height	Processor 0	PCIe Gen5 x16 (x16 connector)
	BOSS (Optional)	34	BOSS	Processor 0	PCIe Gen4 x4 (1C connector)
	RF4c	38	OCP	Processor 0	PCIe Gen5 x16 (x16 connector)
	R1x	2	Full Height	Processor 0	PCIe Gen5 x16 (x16 connector)
	R3b	4	Full Height	Processor 0	PCIe Gen5 x16 (x16 connector)
	R5b	7	Full Height	Processor 0	PCIe Gen5 x16 (x16 connector)
RC 9 - Rear: 2 x16 FH(G5) + 1 x16 Onboard OCP + x4 Optional BOSS	R4b	9	Full Height	Processor 0	PCIe Gen5 x16 (x16 connector)
	R5b	7	Full Height	Processor 0	PCIe Gen5 x16 (x16 connector)
	BOSS (Optional)	6	BOSS	Processor 0	PCIe Gen4 x4 (1C connector)
	Onboard OCP (Optional)	10	OCP	Processor 0	PCIe Gen5 x16 (OCP 4C+ connector)
RC 10 - Rear: 1 x16 Onboard OCP + 1 x16 FLOP OCP + 3 x16 FH (G5) + x4 Optional BOSS	R4b	9	Full Height	Processor 0	PCIe Gen5 x16 (x16 connector)
	R5b	7	Full Height	Processor 0	PCIe Gen5 x16 (x16 connector)
	BOSS (Optional)	6	BOSS	Processor 0	PCIe Gen4 x4 (1C connector)
	Onboard OCP (Optional)	10	OCP	Processor 0	PCIe Gen5 x16 (OCP 4C+ connector)
	R2t	3	Full Height	Processor 0	PCIe Gen5 x16 (x16 connector)
	R3e	4	OCP	Processor 0	PCIe Gen5 x16 (OCP 4C+ connector)

Table 86. Expansion card riser configurations (continued)

Riser Configurations (RC)	Riser/OCP/BOSS	PCIe Slots	Form Factor	Controlling processor	Slot's Electrical Bandwidth/ Physical Connector
RC11: Rear: 1 x16 Onboard OCP + 1 x16 FLOP OCP + 2 x16 FH (G5) + x4 Optional BOSS	R4b	9	Full Height	Processor 0	PCIe Gen5 x16 (x16 connector)
	R5b	7	Full Height	Processor 0	PCIe Gen5 x16 (x16 connector)
	BOSS (Optional)	6	BOSS	Processor 0	PCIe Gen4 x4 (1C connector)
	Onboard OCP (Optional)	10	OCP	Processor 0	PCIe Gen5 x16 (OCP 4C+ connector)
	R3e	4	OCP	Processor 0	PCIe Gen5 x16 (OCP 4C+ connector)

NOTE: The system supports either Front I/O configuration (system with front risers) or Rear I/O configuration (system with rear risers).

Table 87. RC0: No Riser

Card type	Slot priority	Maximum number of cards
Broadcom (OCP: 200Gb)	10	1
Nvidia (OCP: 100Gb)	10	1
Broadcom (OCP: 100Gb)	10	1
Broadcom (OCP: 25Gb)	10	1
Nvidia (OCP: 25Gb)	10	1
Intel (OCP: 10Gb)	10	1
Broadcom (OCP: 10Gb)	10	1
Intel (OCP: 1Gb)	10	1
Broadcom (OCP: 1Gb)	10	1
Santino (BOSS)	6	1
Wistron (BOSS)	6	1
FOXCONN (Front PERC12)	INT	1

Table 88. RC 1: R1x+R2t+R3e+R4b+R5b

Card type	Slot priority	Maximum number of cards
Nvidia (DPU: 200Gb)	7	1
Mellanox (DPU: 200Gb)	7	1
Broadcom (OCP: 200Gb)	10, 4	2
Nvidia (OCP: 100Gb)	10, 4	2
Broadcom (OCP: 100Gb)	10, 4	2
Broadcom (OCP: 25Gb)	10, 4	2
Nvidia (OCP: 25Gb)	10, 4	2
Intel (OCP: 10Gb)	10, 4	2

Table 88. RC 1: R1x+R2t+R3e+R4b+R5b (continued)

Card type	Slot priority	Maximum number of cards
Broadcom (OCP: 10Gb)	10, 4	2
Intel (OCP: 1Gb)	10, 4	2
Broadcom (OCP: 1Gb)	10, 4	2
Santino (BOSS)	6	1
Wistron (BOSS)	6	1
FOXCONN (Front PERC12)	INT	1
Nvidia (GPU)	7, 2, 3, 9	4
Broadcom (NIC: 200Gb)	7, 2, 3, 9	4
Intel (NIC: 100Gb)	7, 2, 3, 9	4
Nvidia (NIC: 100Gb)	7, 2, 3, 9	4
Broadcom (NIC: 100Gb)	7, 2, 3, 9	4
Broadcom (NIC: 25Gb)	7, 2, 3, 9	4
Nvidia (NIC: 25Gb)	7, 2, 3, 9	4
Marvell (HBA: FC64)	7, 2, 3, 9	4
Emulex (HBA: FC64)	7, 2, 3, 9	4
QLogic (HBA: FC32)	7, 2, 3, 9	4
Emulex (HBA: FC32)	7, 2, 3, 9	4
FOXCONN (External Adapter)	7, 2, 3, 9	1

Table 89. RC 2: RF2a+RF4b

Card type	Slot priority	Maximum number of cards
Broadcom (OCP: 200Gb)	38, 34	2
Nvidia (OCP: 100Gb)	38, 34	2
Broadcom (OCP: 100Gb)	38, 34	2
Broadcom (OCP: 25Gb)	38, 34	2
Nvidia (OCP: 25Gb)	38, 34	2
Intel (OCP: 10Gb)	38, 34	2
Broadcom (OCP: 10Gb)	38, 34	2
Intel (OCP: 1Gb)	38, 34	2
Broadcom (OCP: 1Gb)	38, 34	2
Santino (BOSS)	6	1
Wistron (BOSS)	6	1

Table 90. RC 3: RF1a+RF3c

Card type	Slot priority	Maximum number of cards
Nvidia (DPU: 200Gb)	31	1
Mellanox (DPU: 200Gb)	31	1
Santino (BOSS)	34	1
Wistron (BOSS)	34	1

Table 90. RC 3: RF1a+RF3c (continued)

Card type	Slot priority	Maximum number of cards
Nvidia (GPU)	31, 36	2
Broadcom (NIC: 200Gb)	31, 36	2
Intel (NIC: 100Gb)	31, 36	2
Nvidia (NIC: 100Gb)	31, 36	2
Broadcom (NIC: 100Gb)	31, 36	2
Broadcom (NIC: 25Gb)	31, 36	2
Nvidia (NIC: 25Gb)	31, 36	2
Marvell (HBA: FC64)	31, 36	2
Emulex (HBA: FC64)	31, 36	2
QLogic (HBA: FC32)	31, 36	2
Emulex (HBA: FC32)	31, 36	2
FOXCONN (External Adapter)	31, 36	1

Table 91. RC4. RF1a+RF2a+RF3d+RF4a

Card type	Slot priority	Maximum number of cards
Nvidia (DPU: 200Gb)	31	1
Mellanox (DPU: 200Gb)	31	1
Broadcom (OCP: 200Gb)	38, 34	2
Nvidia (OCP: 100Gb)	38, 34	2
Broadcom (OCP: 100Gb)	38, 34	2
Broadcom (OCP: 25Gb)	38, 34	2
Nvidia (OCP: 25Gb)	38, 34	2
Intel (OCP: 10Gb)	38, 34	2
Broadcom (OCP: 10Gb)	38, 34	2
Intel (OCP: 1Gb)	38, 34	2
Broadcom (OCP: 1Gb)	38, 34	2
Santino (BOSS)	6	1
Wistron (BOSS)	6	1
Nvidia (GPU)	31, 36	2
Broadcom (NIC: 200Gb)	31, 36	2
Intel (NIC: 100Gb)	31, 36	2
Nvidia (NIC: 100Gb)	31, 36	2
Broadcom (NIC: 100Gb)	31, 36	2
Broadcom (NIC: 25Gb)	31, 36	2
Nvidia (NIC: 25Gb)	31, 36	2
Marvell (HBA: FC64)	31, 36	2
Emulex (HBA: FC64)	31, 36	2
QLogic (HBA: FC32)	31, 36	2

Table 91. RC4. RF1a+RF2a+RF3d+RF4a (continued)

Card type	Slot priority	Maximum number of cards
Emulex (HBA: FC32)	31, 36	2
FOXCONN (External Adapter)	31, 36	1

Table 92. RC 5: R3f+R4b+R5b

Card type	Slot priority	Maximum number of cards
Nvidia (DPU: 200Gb)	7	1
Mellanox (DPU: 200Gb)	7	1
Broadcom (OCP: 200Gb)	10, 4	2
Nvidia (OCP: 100Gb)	10, 4	2
Broadcom (OCP: 100Gb)	10, 4	2
Broadcom (OCP: 25Gb)	10, 4	2
Nvidia (OCP: 25Gb)	10, 4	2
Intel (OCP: 10Gb)	10, 4	2
Broadcom (OCP: 10Gb)	10, 4	2
Intel (OCP: 1Gb)	10, 4	2
Broadcom (OCP: 1Gb)	10, 4	2
Santino (BOSS)	6	1
Wistron (BOSS)	6	1
FOXCONN (Front PERC12)	INT	1
Nvidia (GPU)	7, 9	2
Broadcom (NIC: 200Gb)	7, 9	2
Intel (NIC: 100Gb)	7, 9	2
Nvidia (NIC: 100Gb)	7, 9	2
Broadcom (NIC: 100Gb)	7, 9	2
Broadcom (NIC: 25Gb)	7, 9	2
Nvidia (NIC: 25Gb)	7, 9	2
Marvell (HBA: FC64)	7, 9	2
Emulex (HBA: FC64)	7, 9	2
QLogic (HBA: FC32)	7, 9	2
Emulex (HBA: FC32)	7, 9	2
FOXCONN (External Adapter)	7, 9	1

Table 93. RC6. R1x+R3b+R4b+R5b

Card type	Slot priority	Maximum number of cards
Nvidia (DPU: 200Gb)	7	1
Mellanox (DPU: 200Gb)	7	1
Broadcom (OCP: 200Gb)	10	1
Nvidia (OCP: 100Gb)	10	1
Broadcom (OCP: 100Gb)	10	1

Table 93. RC6. R1x+R3b+R4b+R5b (continued)

Card type	Slot priority	Maximum number of cards
Broadcom (OCP: 25Gb)	10	1
Nvidia (OCP: 25Gb)	10	1
Intel (OCP: 10Gb)	10	1
Broadcom (OCP: 10Gb)	10	1
Intel (OCP: 1Gb)	10	1
Broadcom (OCP: 1Gb)	10	1
Santino (BOSS)	6	1
Wistron (BOSS)	6	1
Nvidia (GPU)	7, 4, 2	3
Nvidia (GPU)	7, 4, 2, 9	4
Broadcom (NIC: 200Gb)	7, 4, 2, 9	4
Intel (NIC: 100Gb)	7, 4, 2, 9	4
Nvidia (NIC: 100Gb)	7, 4, 2, 9	4
Broadcom (NIC: 100Gb)	7, 4, 2, 9	4
Broadcom (NIC: 25Gb)	7, 4, 2, 9	4
Nvidia (NIC: 25Gb)	7, 4, 2, 9	4
Marvell (HBA: FC64)	7, 4, 2, 9	4
Emulex (HBA: FC64)	7, 4, 2, 9	4
QLogic (HBA: FC32)	7, 4, 2, 9	4
Emulex (HBA: FC32)	7, 4, 2, 9	4
FOXCONN (External Adapter)	7, 4, 2, 9	1

Table 94. RC 7: R3f+R4b+R5b

Card type	Slot priority	Maximum number of cards
Broadcom (OCP: 25Gb)	10, 4	2
Nvidia (OCP: 25Gb)	10, 4	2
Intel (OCP: 10Gb)	10, 4	2
Broadcom (OCP: 10Gb)	10, 4	2
Intel (OCP: 1Gb)	10, 4	2
Broadcom (OCP: 1Gb)	10, 4	2
Santino (BOSS)	6	1
Wistron (BOSS)	6	1
FOXCONN (PERC Adapter12)	7	1
Broadcom (NIC: 200Gb)	9	1
Intel (NIC: 100Gb)	9	1
Nvidia (NIC: 100Gb)	9	1
Broadcom (NIC: 100Gb)	9	1
Broadcom (NIC: 25Gb)	9	1

Table 94. RC 7: R3f+R4b+R5b (continued)

Card type	Slot priority	Maximum number of cards
Nvidia (NIC: 25Gb)	9	1
Marvell (HBA: FC64)	9	1
Emulex (HBA: FC64)	9	1
QLogic (HBA: FC32)	9	1
Emulex (HBA: FC32)	9	1
FOXCONN (External Adapter)	9	1

Table 95. RC8. RF1a+RF4c+R1x+R3b+R5b

Card type	Slot priority	Maximum number of cards
Nvidia (DPU: 200Gb)	7	1
Mellanox (DPU: 200Gb)	7	1
Broadcom (OCP: 200Gb)	38	1
Nvidia (OCP: 100Gb)	38	1
Broadcom (OCP: 100Gb)	38	1
Broadcom (OCP: 25Gb)	38	1
Nvidia (OCP: 25Gb)	38	1
Intel (OCP: 10Gb)	38	1
Broadcom (OCP: 10Gb)	38	1
Intel (OCP: 1Gb)	38	1
Broadcom (OCP: 1Gb)	38	1
Santino (BOSS)	34	1
Wistron (BOSS)	34	1
Nvidia (GPU)	7, 2	2
Nvidia (GPU)	31, 7, 4, 2	4
Broadcom (NIC: 200Gb)	31, 7, 4, 2	4
Intel (NIC: 100Gb)	31, 7, 4, 2	4
Nvidia (NIC: 100Gb)	31, 7, 4, 2	4
Broadcom (NIC: 100Gb)	31, 7, 4, 2	4
Broadcom (NIC: 25Gb)	31, 7, 4, 2	4
Nvidia (NIC: 25Gb)	31, 7, 4, 2	4
Marvell (HBA: FC64)	31, 7, 4, 2	4
Emulex (HBA: FC64)	31, 7, 4, 2	4
QLogic (HBA: FC32)	31, 7, 4, 2	4
Emulex (HBA: FC32)	31, 7, 4, 2	4
FOXCONN (External Adapter)	31, 7, 4, 2	1

Table 96. RC 9: R4b+R5b

Card type	Slot priority	Maximum number of cards
Nvidia (DPU: 200Gb)	7	1

Table 96. RC 9: R4b+R5b (continued)

Card type	Slot priority	Maximum number of cards
Mellanox (DPU: 200Gb)	7	1
Broadcom (OCP: 200Gb)	10	1
Nvidia (OCP: 100Gb)	10	1
Broadcom (OCP: 100Gb)	10	1
Broadcom (OCP: 25Gb)	10	1
Nvidia (OCP: 25Gb)	10	1
Intel (OCP: 10Gb)	10	1
Broadcom (OCP: 10Gb)	10	1
Intel (OCP: 1Gb)	10	1
Broadcom (OCP: 1Gb)	10	1
Santino (BOSS)	6	1
Wistron (BOSS)	6	1
FOXCONN (Front PERC12)	INT	1
Nvidia (GPU)	7, 9	2
Broadcom (NIC: 200Gb)	7, 9	2
Intel (NIC: 100Gb)	7, 9	2
Nvidia (NIC: 100Gb)	7, 9	2
Broadcom (NIC: 100Gb)	7, 9	2
Broadcom (NIC: 25Gb)	7, 9	2
Nvidia (NIC: 25Gb)	7, 9	2
Marvell (HBA: FC64)	7, 9	2
Emulex (HBA: FC64)	7, 9	2
QLogic (HBA: FC32)	7, 9	2
Emulex (HBA: FC32)	7, 9	2
FOXCONN (External Adapter)	7, 9	1

Table 97. RC10. R2t+R3e+R4b+R5b

Card type	Slot priority	Maximum number of cards
Nvidia (DPU: 200Gb)	7	1
Mellanox (DPU: 200Gb)	7	1
Broadcom (OCP: 200Gb)	10, 4	2
Nvidia (OCP: 100Gb)	10, 4	2
Broadcom (OCP: 100Gb)	10, 4	2
Broadcom (OCP: 25Gb)	10, 4	2
Nvidia (OCP: 25Gb)	10, 4	2
Intel (OCP: 10Gb)	10, 4	2
Broadcom (OCP: 10Gb)	10, 4	2
Intel (OCP: 1Gb)	10, 4	2

Table 97. RC10. R2t+R3e+R4b+R5b (continued)

Card type	Slot priority	Maximum number of cards
Broadcom (OCP: 1Gb)	10, 4	2
Santino (BOSS)	6	1
Wistron (BOSS)	6	1
FOXCONN (PERC Adapter12)	7	1
Nvidia (GPU)	9, 3	2
Broadcom (NIC: 200Gb)	9, 3	2
Intel (NIC: 100Gb)	9, 3	2
Nvidia (NIC: 100Gb)	9, 3	2
Broadcom (NIC: 100Gb)	9, 3	2
Broadcom (NIC: 25Gb)	9, 3	2
Nvidia (NIC: 25Gb)	9, 3	2
Marvell (HBA: FC64)	9, 3	2
Emulex (HBA: FC64)	9, 3	2
QLogic (HBA: FC32)	9, 3	2
Emulex (HBA: FC32)	9, 3	2
FOXCONN (External Adapter)	9, 3	1

Table 98. RC11. R3e+R4b+R5b

Card type	Slot priority	Maximum number of cards
Nvidia (DPU: 200Gb)	7	1
Mellanox (DPU: 200Gb)	7	1
Broadcom (OCP: 200Gb)	10, 4	2
Nvidia (OCP: 100Gb)	10, 4	2
Broadcom (OCP: 100Gb)	10, 4	2
Broadcom (OCP: 25Gb)	10, 4	2
Nvidia (OCP: 25Gb)	10, 4	2
Intel (OCP: 10Gb)	10, 4	2
Broadcom (OCP: 10Gb)	10, 4	2
Intel (OCP: 1Gb)	10, 4	2
Broadcom (OCP: 1Gb)	10, 4	2
Santino (BOSS)	6	1
Wistron (BOSS)	6	1
Nvidia (GPU)	7, 9	2
Broadcom (NIC: 200Gb)	7, 9	2
Intel (NIC: 100Gb)	7, 9	2
Nvidia (NIC: 100Gb)	7, 9	2
Broadcom (NIC: 100Gb)	7, 9	2
Broadcom (NIC: 25Gb)	7, 9	2

Table 98. RC11. R3e+R4b+R5b (continued)

Card type	Slot priority	Maximum number of cards
Nvidia (NIC: 25Gb)	7, 9	2
Marvell (HBA: FC64)	7, 9	2
Emulex (HBA: FC64)	7, 9	2
QLogic (HBA: FC32)	7, 9	2
Emulex (HBA: FC32)	7, 9	2
FOXCONN (External Adapter)	7, 9	1

Removing the front expansion card risers

Prerequisites

1. Follow the safety guidelines listed in the [Safety instructions](#).
2. Follow the procedure listed in the [Before working inside your system](#).
3. [Remove the cooling fan assembly](#).
4. [Remove the drive backplane cover](#).
5. Disconnect the cables, observe the cable routing.

 **NOTE:** See [cable routing](#) section for more information.

Steps

1. For front riser 1:
 - a. Disconnect the riser cable from the system board.
 - b. Press and lift the cable holder on the cooling fan cage assembly.
 - c. Loosen the captive screws on the riser.
 - d. Slide the riser 1 out of the system.

 **NOTE:** The numbers on the image do not depict the exact steps. The numbers are for representation of sequence.

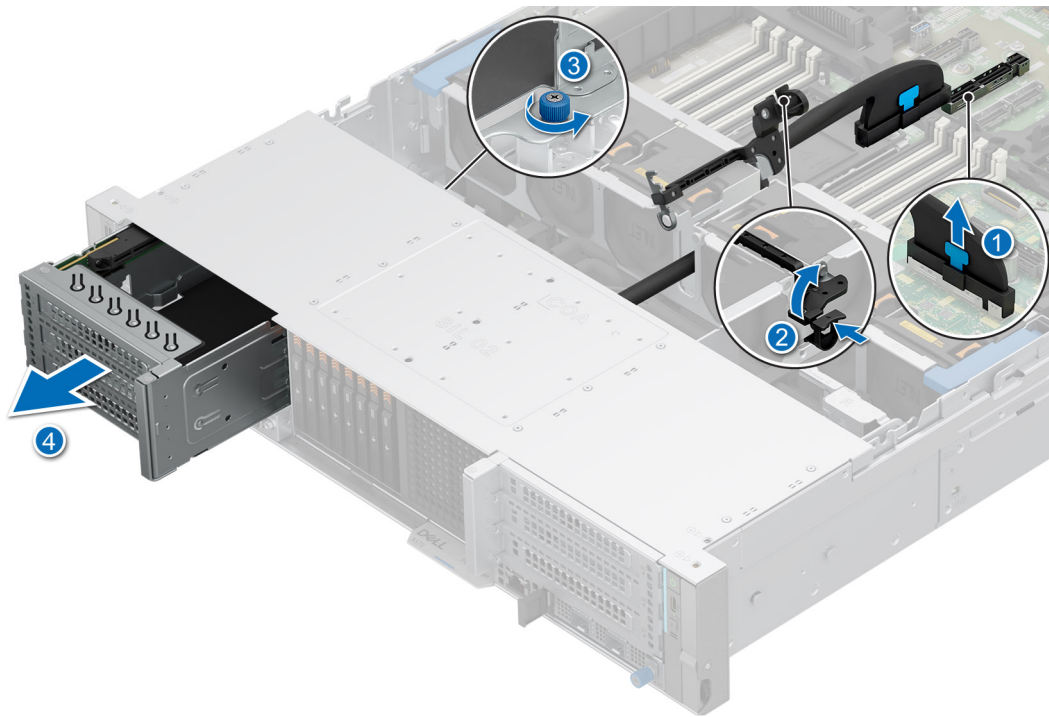

Figure 136. Removing the front expansion card riser 1

2. For front riser 3:
 - a. Disconnect the cable from the system board.
 - b. Loosen the captive screws on the riser.
 - c. Slide the riser 3 out of the system.

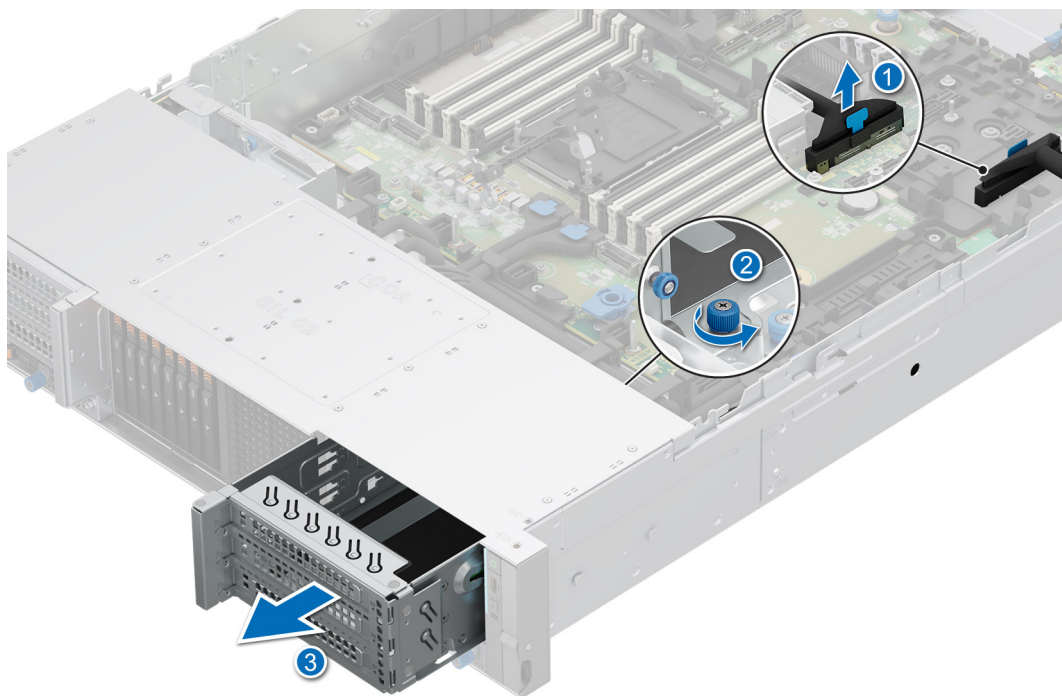

Figure 137. Removing the front expansion card riser 3

3. For front riser 2:
 - a. Disconnect the cable from the system board.
 - b. Press and lift the cable holder on the cooling fan cage assembly.

- c. Loosen the captive screws on the riser.
- d. Slide the riser 2 out of the system.

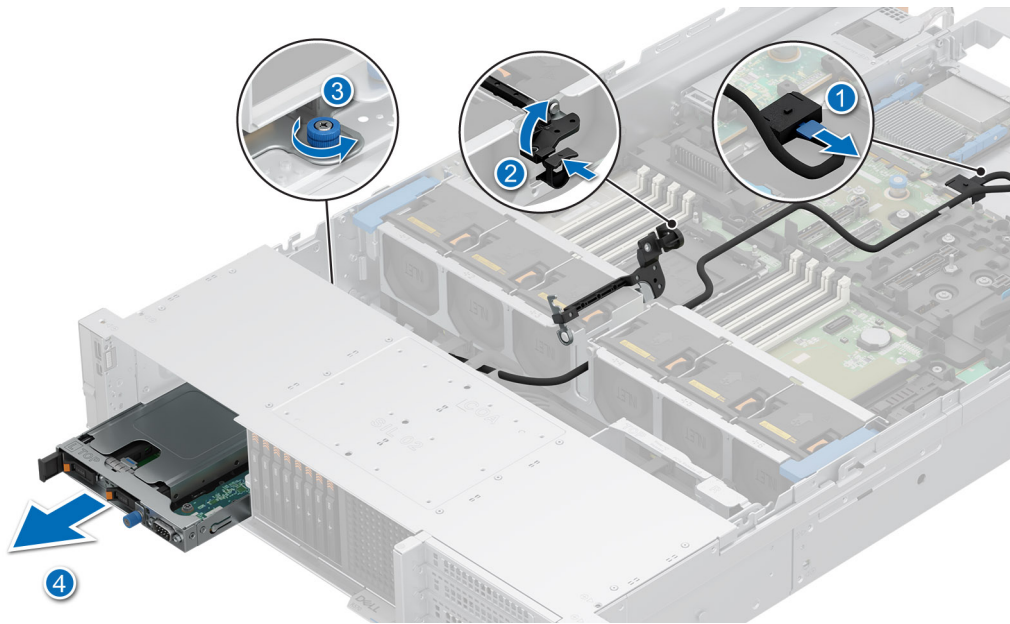

Figure 138. Removing the front expansion card riser 2

- 4. For front riser 4:
 - a. Disconnect the cable from the system board.
 - b. Press and lift the cable holder on the cooling fan cage assembly.
 - c. Loosen the captive screws on the riser.
 - d. Slide the riser 4 out of the system.

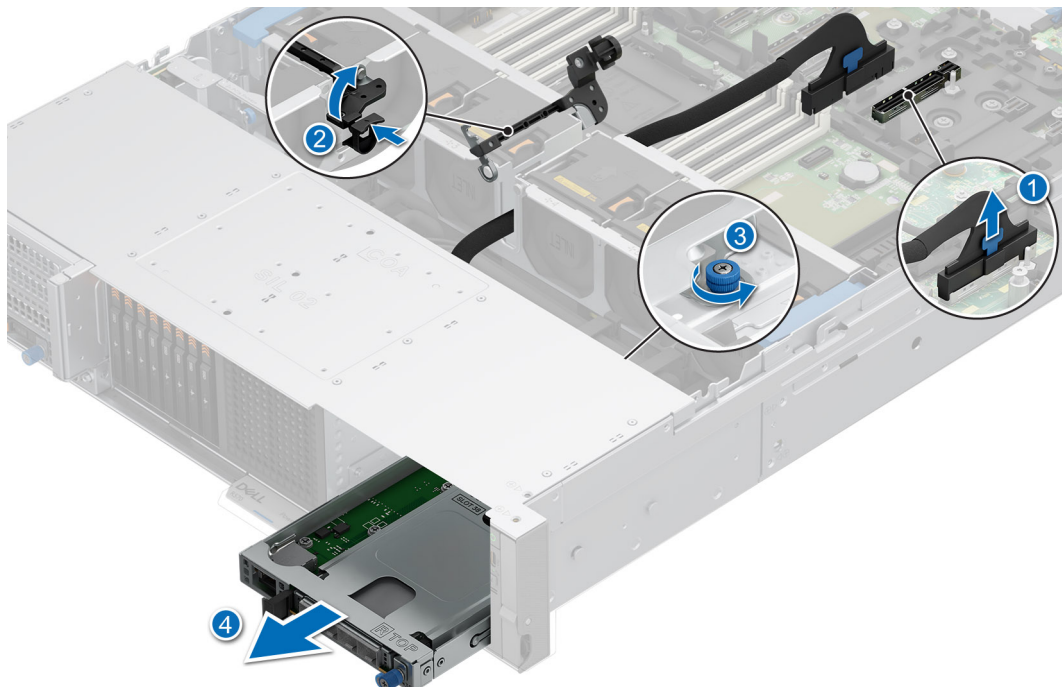

Figure 139. Removing the front expansion card riser 4

Next steps

- 1. [Replace the front expansion card riser.](#)

Installing the front expansion card risers

Prerequisites

1. Follow the safety guidelines listed in the [Safety instructions](#).
2. Follow the procedure listed in the [Before working inside your system](#).
3. [Remove the cooling fan assembly](#).
4. [Remove the drive backplane cover](#).
5. Disconnect the cables, observe the cable routing.

NOTE: See [cable routing](#) section for more information.

Steps

1. For front riser 2:
 - a. Align and slide the riser 2 into the system bay.
 - b. Route and connect the cable to the system board.
 - c. Tighten the captive screw.

NOTE: The numbers on the image do not depict the exact steps. The numbers are for representation of sequence.

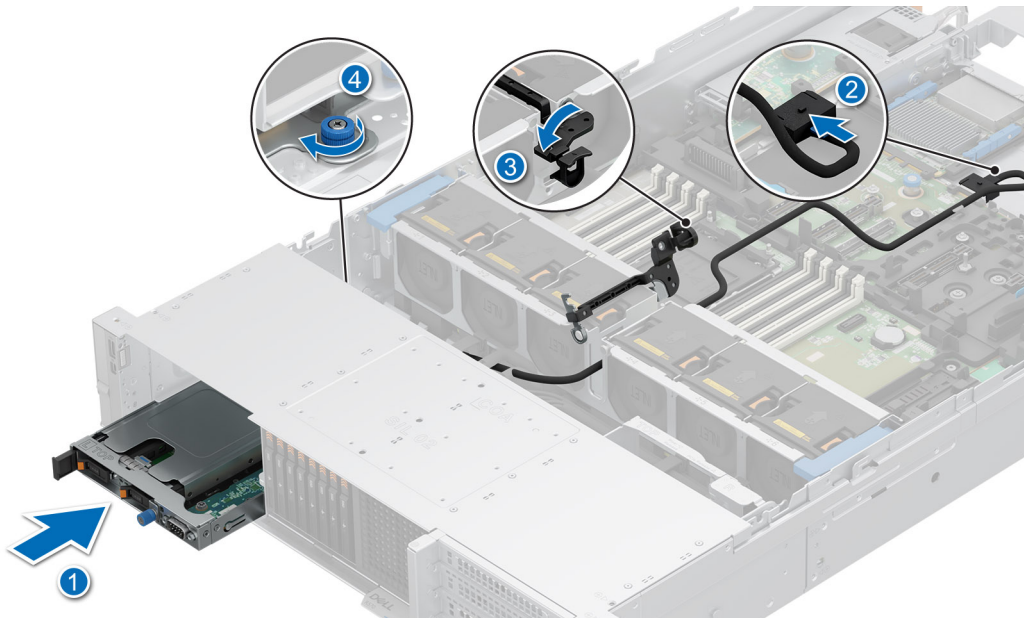

Figure 140. Installing the front expansion card riser 2

2. For front riser 4:
 - a. Align and slide the riser 4 into the system bay.
 - b. Route and connect the cable to the system board.
 - c. Tighten the captive screw.

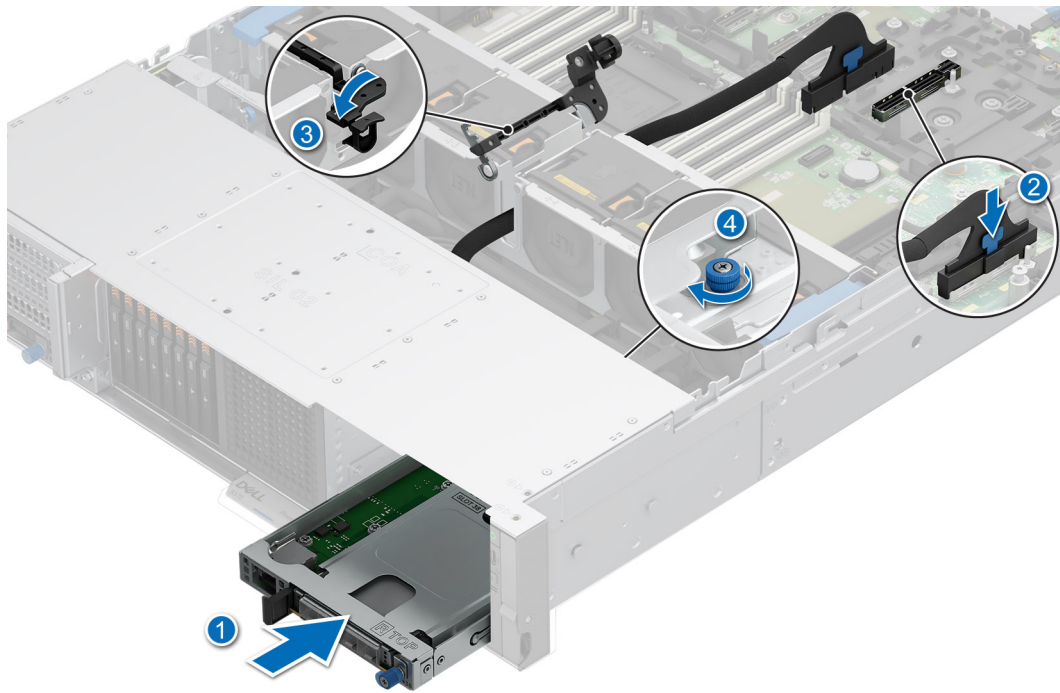

Figure 141. Installing the front expansion card riser 4

3. For front riser 3:
 - a. Align and slide the riser 3 into the system bay.
 - b. Route and connect the cable to the system board.
 - c. Tighten the captive screw.

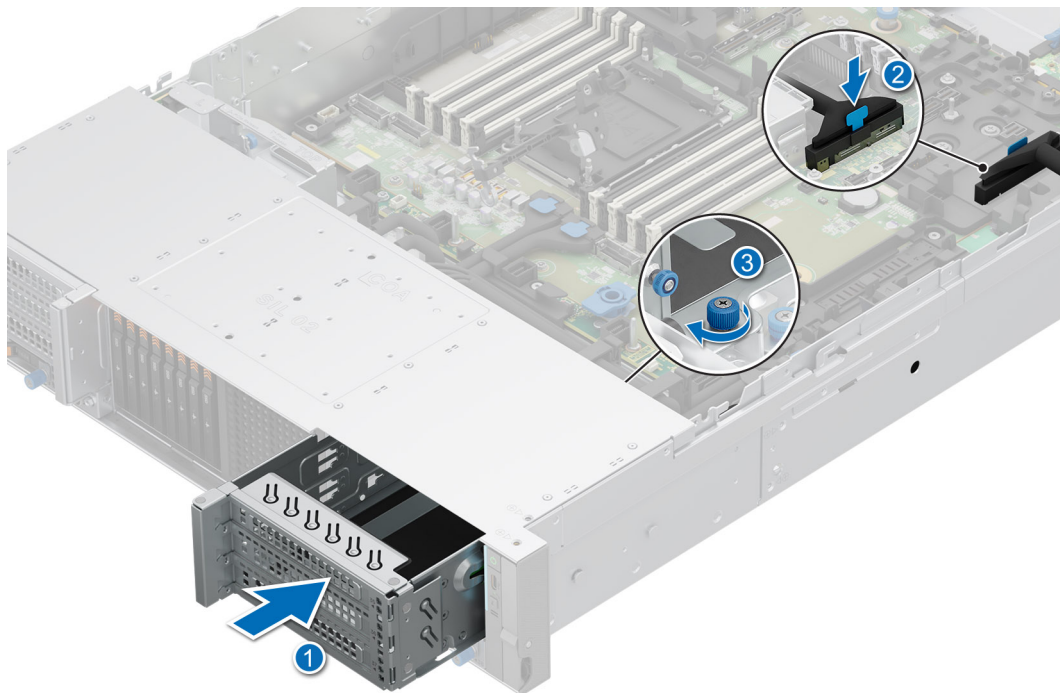

Figure 142. Installing the front expansion card riser 3

4. For front riser 1:
 - a. Align and slide the riser 1 into the system bay.
 - b. Route and connect the cable to the system board.
 - c. Tighten the captive screw.

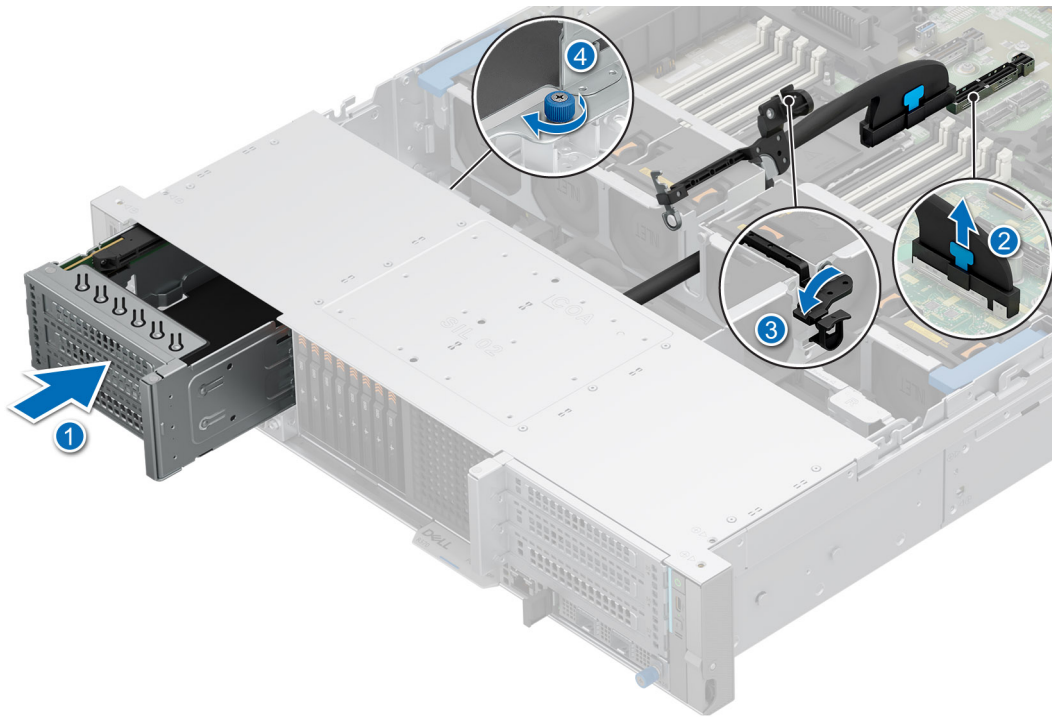

Figure 143. Installing the front expansion card riser 1

Next steps

1. Route and connect the cables, taking care not to damage them.

NOTE: See [cable routing](#) section for more information.

2. [Install the cooling fans.](#)
3. [Install the drive backplane cover.](#)
4. Follow the procedure listed in the [After working inside your system.](#)

Removing an expansion card from the front expansion card riser

Prerequisites

1. Follow the safety guidelines listed in the [Safety instructions.](#)
2. Follow the procedure listed in [Before working inside your system.](#)
3. If required, [remove the air shroud.](#)
4. If required, [remove the cooling fan cage assembly.](#)
5. [Remove the drive backplane cover.](#)
6. If applicable, disconnect the cables from the expansion card.
7. [Remove the front expansion card riser.](#)
8. There are four front risers, and the process for removing the expansion card from each is similar.

Steps

1. For Full Height (FH) card:
 - a. Pull the plunger and tilt the expansion card retention latch lock to open.
 - b. Hold the expansion card by the edges and pull the card from the riser.

NOTE: The numbers on the image do not depict the exact steps. The numbers are for representation of sequence.

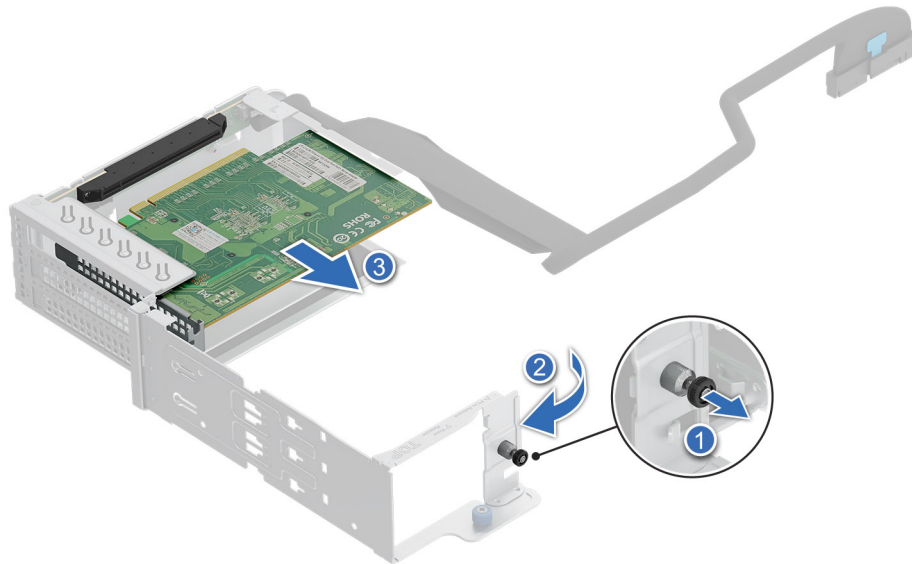

Figure 144. Removing FH expansion card from the front expansion card riser

2. For Low profile (LP) card:
 - a. Pull the plunger and tilt the expansion card retention latch lock to open.
 - b. Hold the expansion card by the edges and pull the card from the riser.
 - c. Slide and remove the card holder.

i **NOTE:** The numbers on the image do not depict the exact steps. The numbers are for representation of sequence.

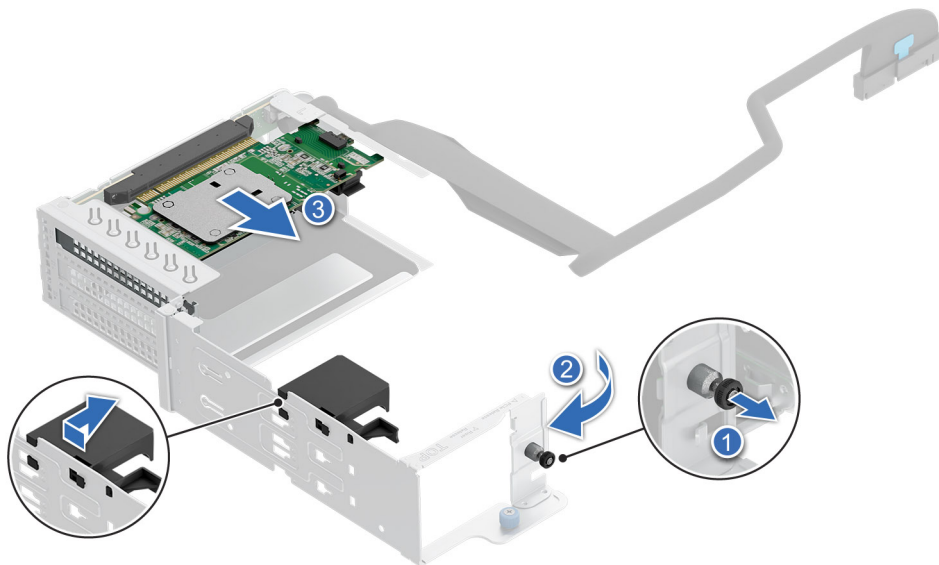

Figure 145. Removing LP expansion card from the front expansion card riser

3. If the expansion card is not going to be replaced, install a filler bracket and close the card retention latch.

i **NOTE:** You must install a filler bracket over an empty expansion card slot to maintain Federal Communications Commission (FCC) certification of the system. The brackets also keep dust and dirt out of the system and aid in proper cooling and airflow inside the system.

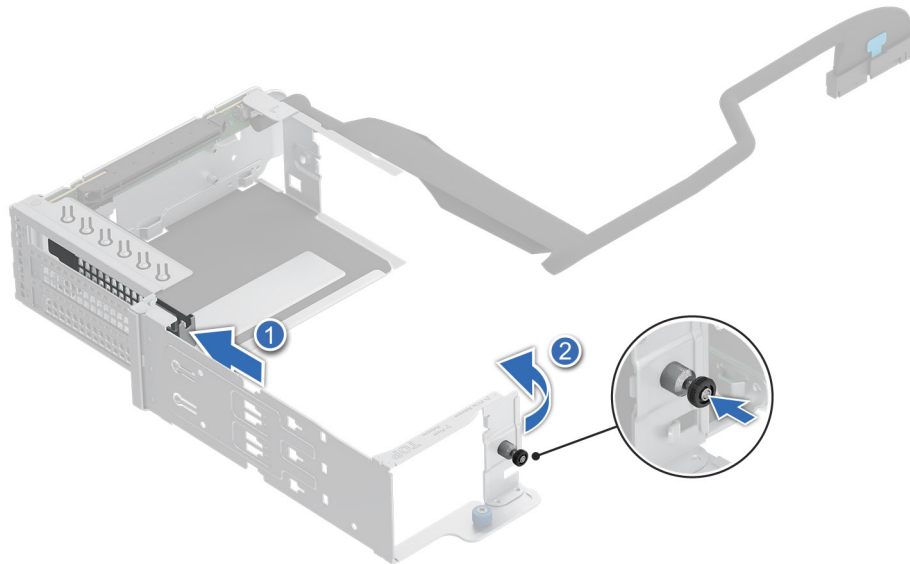

Figure 146. Installing the filler bracket

Next steps

1. If applicable, [install an expansion card into the expansion card riser](#).

Installing an expansion card into the front expansion card riser

Prerequisites

1. Follow the safety guidelines listed in the [Safety instructions](#).
2. Follow the procedure listed in [Before working inside your system](#).
3. If required, [remove the air shroud](#).
4. If required, [remove the cooling fan cage assembly](#).
5. [Remove the drive backplane cover](#).
6. If applicable, disconnect the cables from the expansion card.
7. [Remove the front expansion card riser](#).
8. There are four front risers, and the process for installing the expansion card from each is similar.
9. If installing a new expansion card, unpack it and prepare the card for installation.

NOTE: For instructions, see the documentation accompanying the card.

CAUTION: Do not install GPUs, network cards, or other PCIe devices on your system that are not validated and tested by Dell. Damage caused by unauthorized and invalidated hardware installation will null and void the system warranty.

Steps

1. Tilt the expansion card retention latch lock to open.
2. If installed, remove the filler bracket.

NOTE: Store the filler bracket for future use. Filler brackets must be installed in empty expansion card slots to maintain Federal Communications Commission (FCC) certification of the system. The brackets also keep dust and dirt out of the system and aid in proper cooling and airflow inside the system.

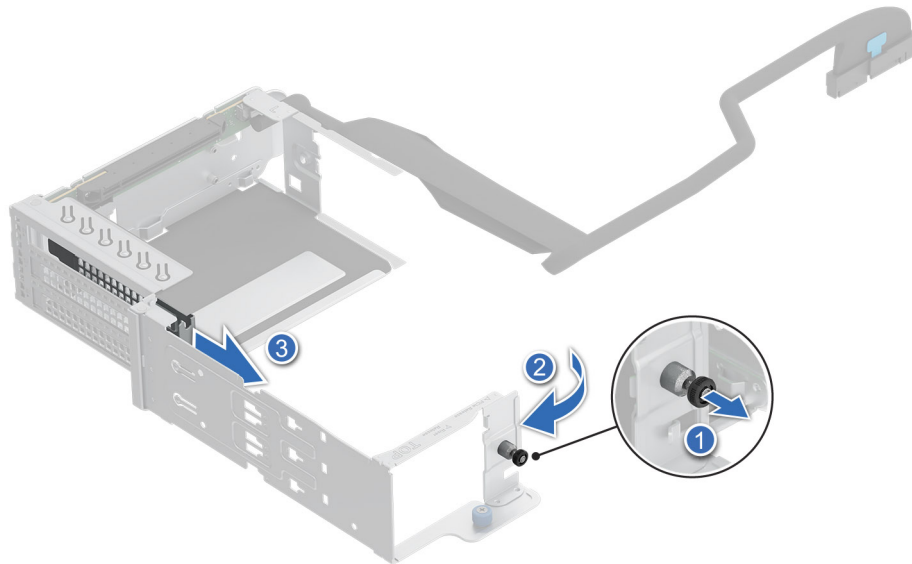

Figure 147. Removing the filler bracket

3. For Low profile (LP) card:
 - a. Hold the card by edges, and align the card with the connector on the riser.
 - b. Insert the card firmly into the expansion card connector until seated.
 - c. Align and slide the card holder guides into the slots on the riser card retention latch until seated.
 - d. Close the expansion card retention latch until the plunger locks in place.

i **NOTE:** The numbers on the image do not depict the exact steps. The numbers are for representation of sequence.

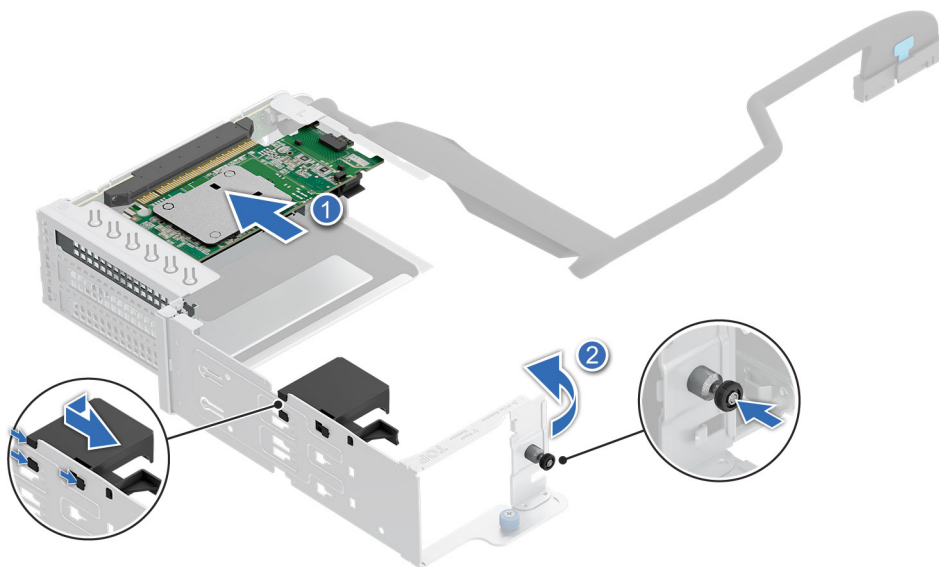

Figure 148. Installing a LP expansion card into the front expansion card riser

4. For Full Height (FH) card:
 - a. Hold the card by edges, and align the card with the connector on the riser.
 - b. Insert the card firmly into the expansion card connector until seated.
 - c. Close the expansion card retention latch until the plunger locks in place.

i **NOTE:** The numbers on the image do not depict the exact steps. The numbers are for representation of sequence.

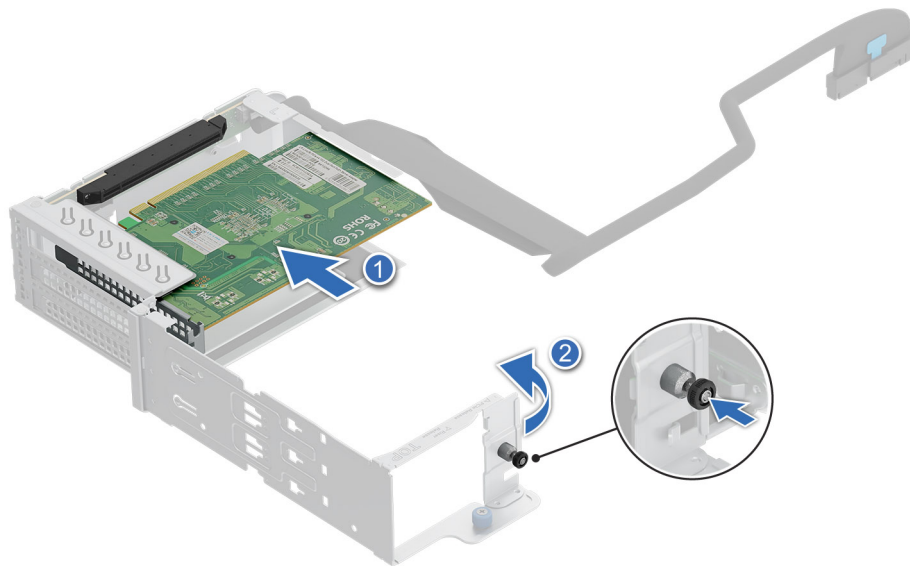

Figure 149. Installing a FH expansion card into the front expansion card riser

Next steps

1. If applicable, connect the cables to the expansion card.

i **NOTE:** See [cable routing](#) section for more information.

2. [Install the expansion card risers.](#)
3. If removed, [install the cooling fan cage assembly.](#)
4. If removed, [install the air shroud.](#)
5. [Install the drive backplane cover.](#)
6. Follow the procedure listed in the [After working inside your system.](#)
7. Install any device drivers required for the card as described in the documentation for the card.

Removing the rear expansion card risers

Prerequisites

1. Follow the safety guidelines listed in the [Safety instructions.](#)
2. Follow the procedure listed in the [Before working inside your system.](#)
3. [Remove the system cover](#)
4. If applicable, disconnect the cables from the expansion card or HPM board.

Steps

1. For rear riser 1, riser 3, and riser 5:
 - a. Loosen the captive screws on the riser and system.
 - b. Press the blue release tab on the riser and holding the edges lift the expansion card riser from the connector on the system board.

i **NOTE:** The numbers on the image do not depict the exact steps. The numbers are for representation of sequence.

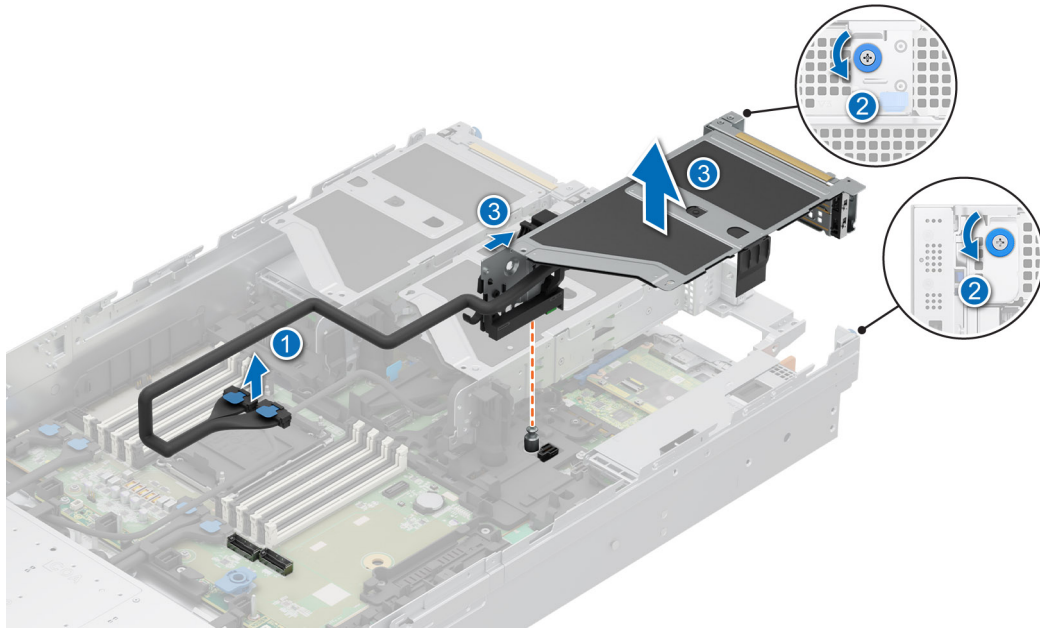

Figure 150. Removing the rear expansion card riser 1

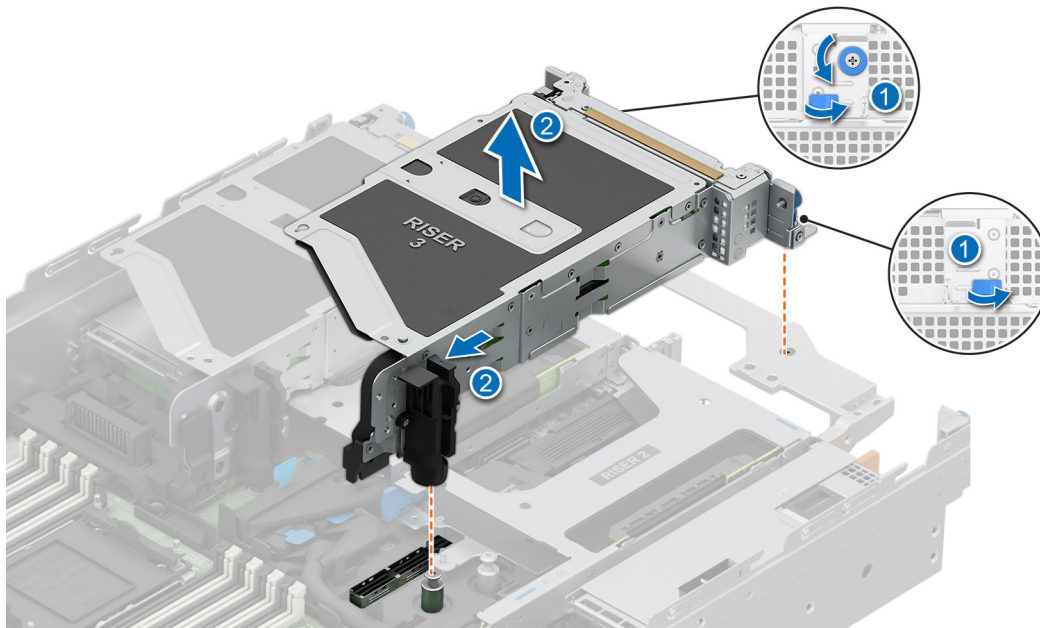

Figure 151. Removing the rear expansion card riser 3

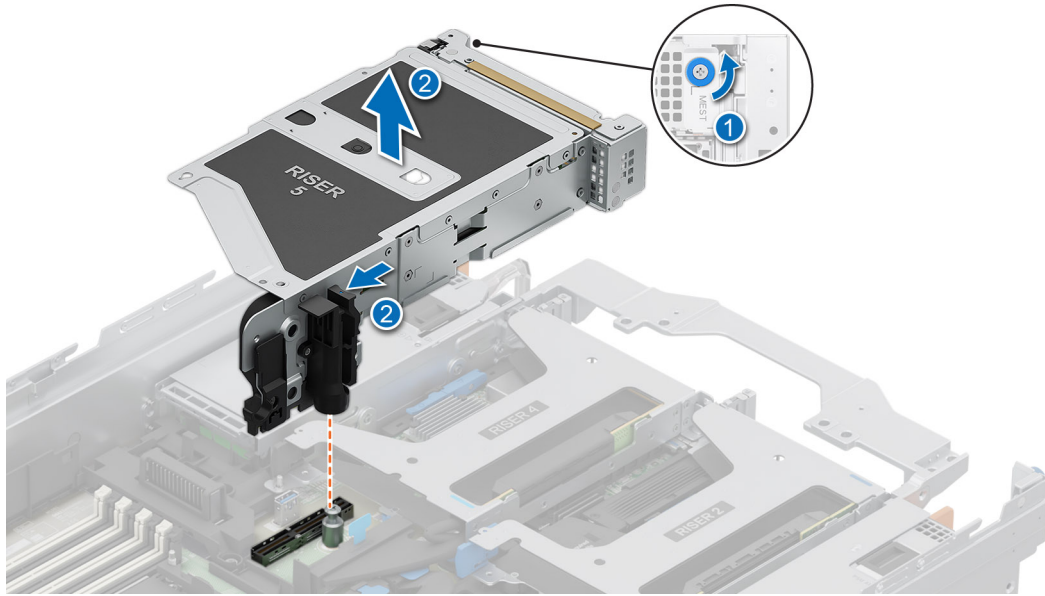

Figure 152. Removing the rear expansion card riser 5

2. For rear riser 2:
 - a. Slide the knob to unlock position.
 - b. Holding the edges lift the expansion card riser from the riser connector on the system board.

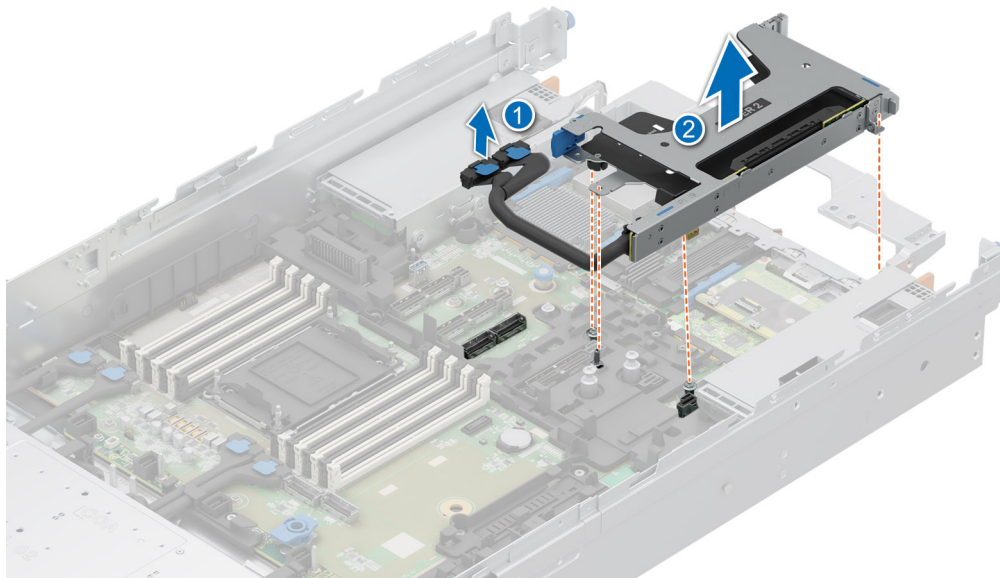

Figure 153. Removing the rear expansion card riser 2

3. For rear riser 4:
 - a. Pull and disconnect the riser cable from the system board.
 - b. Holding the edges lift the expansion card riser from the riser connector on the system board.

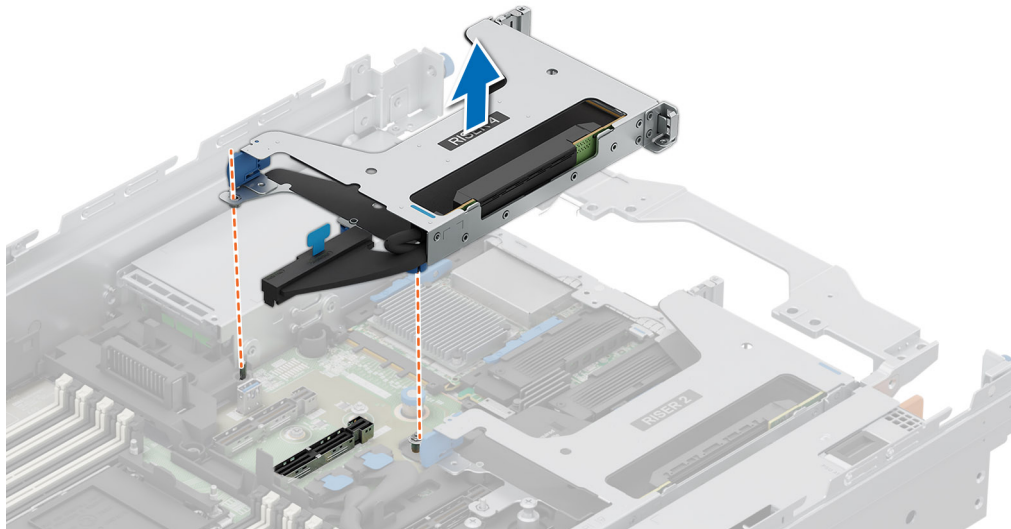

Figure 154. Removing the rear expansion card riser 4

Next steps

1. Follow the procedure listed in [After working inside your system.](#)
2. [Replace the rear expansion card risers](#)

Installing the rear expansion card risers

Prerequisites

1. Follow the safety guidelines listed in the [Safety instructions.](#)
2. Follow the procedure listed in the [Before working inside your system.](#)
3. [Remove the system cover](#)
4. If removed, [install the expansion cards into the rear expansion card risers.](#)

CAUTION: Do not install GPUs, network cards, or other PCIe devices on your system that are not validated and tested by Dell. Damage caused by unauthorized and invalidated hardware installation will null and void the system warranty.

Steps

1. For rear riser 4:
 - a. Holding the edges or the touch points, align the holes on the expansion card riser with the guides on the system board.
 - b. Lower the expansion card riser into place and press the touch points until the expansion card riser is fully seated on the system board.
 - c. Connect the riser cable connector to the system board.

NOTE: The numbers on the image do not depict the exact steps. The numbers are for representation of sequence.

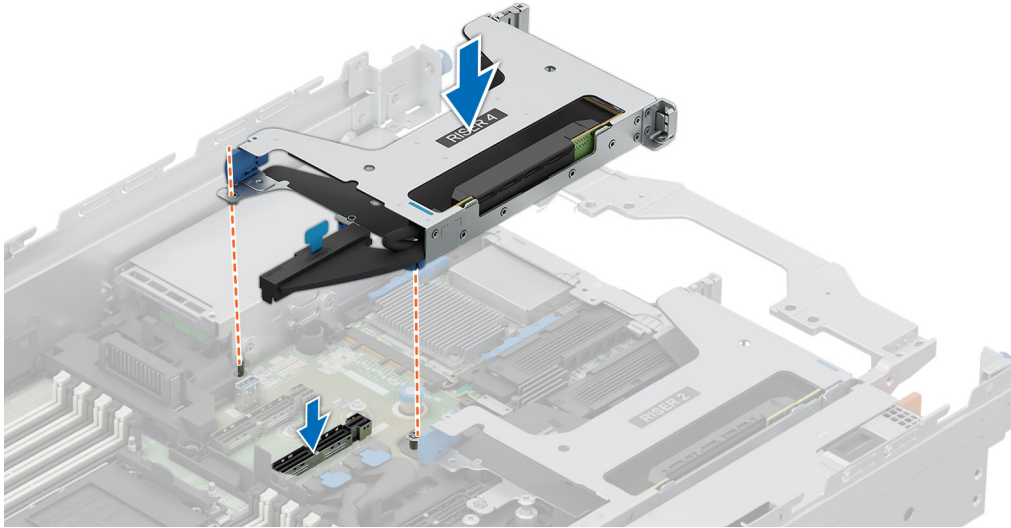

Figure 155. Installing the rear expansion card riser 4

2. For rear riser 2:
 - a. Holding the edges or the touch points, align the holes on the expansion card riser with the guides on the system board.
 - b. Lower the expansion card riser into place and press the touch points until the expansion card riser connector is fully seated on the system board connector.
 - c. Slide the knob into lock position.

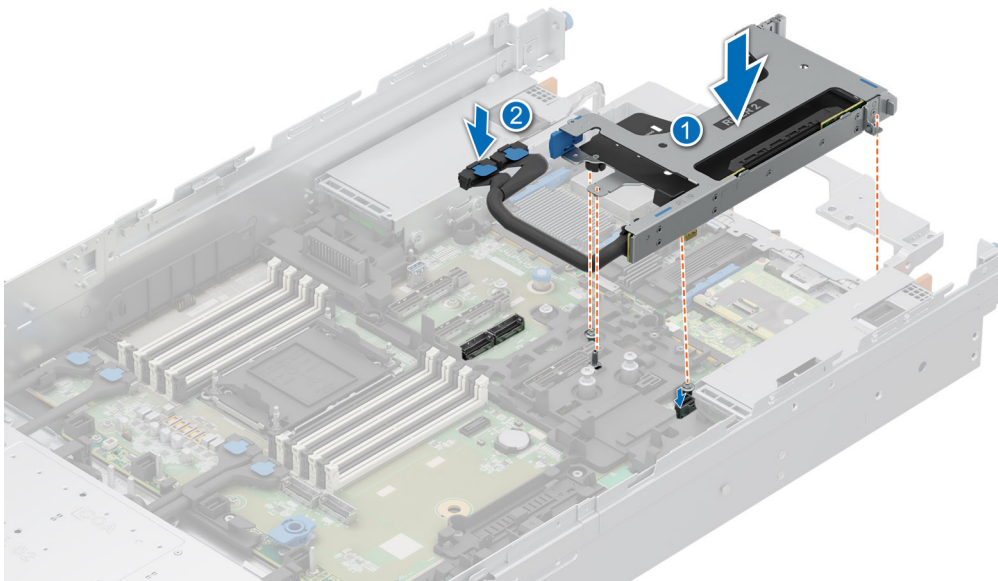

Figure 156. Installing the rear expansion card riser 2

3. For rear riser 1, riser 3, and riser 5:
 - a. Holding the edges or the touch points, align the holes on the expansion card riser with the guides on the system board.
 - b. Lower the expansion card riser into place and press the touch points until the expansion card riser connector is fully seated on the system board connector.
 - c. Tighten the captive screws on the risers and system if any.

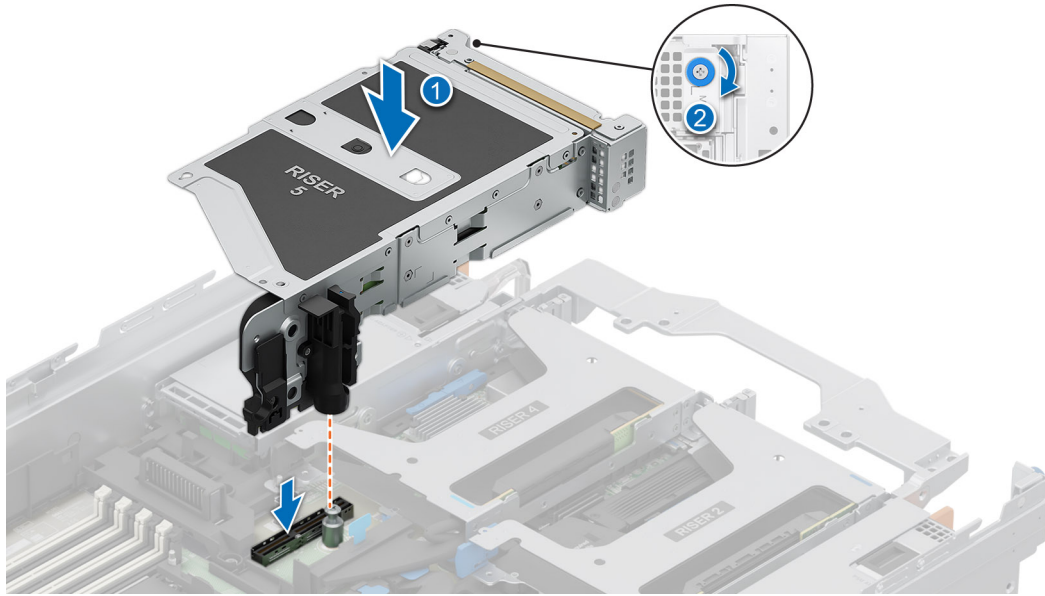

Figure 157. Installing the rear expansion card riser 5

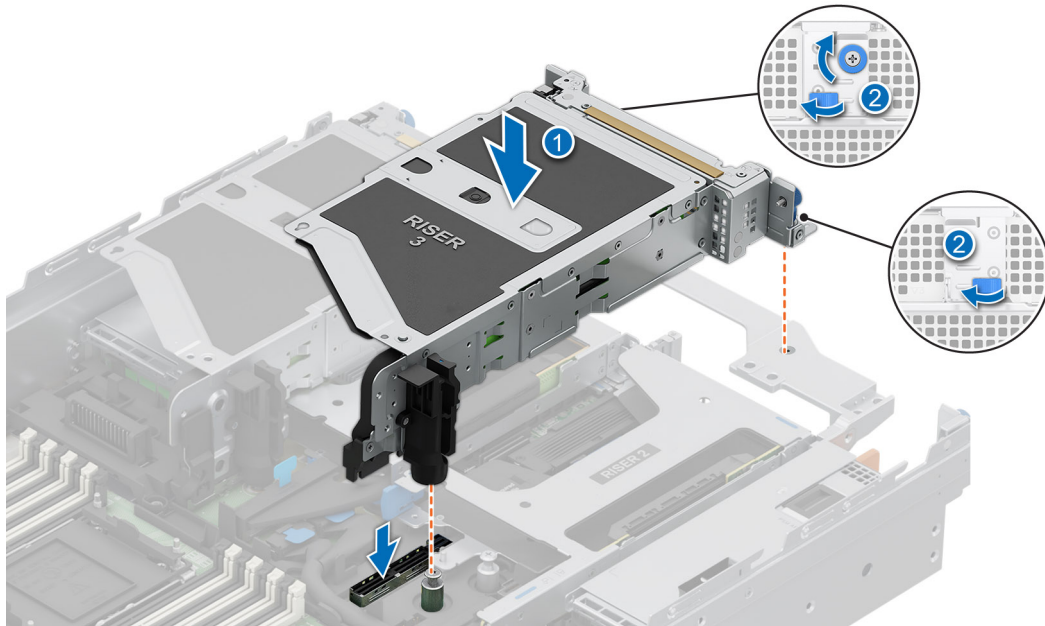

Figure 158. Installing the rear expansion card riser 3

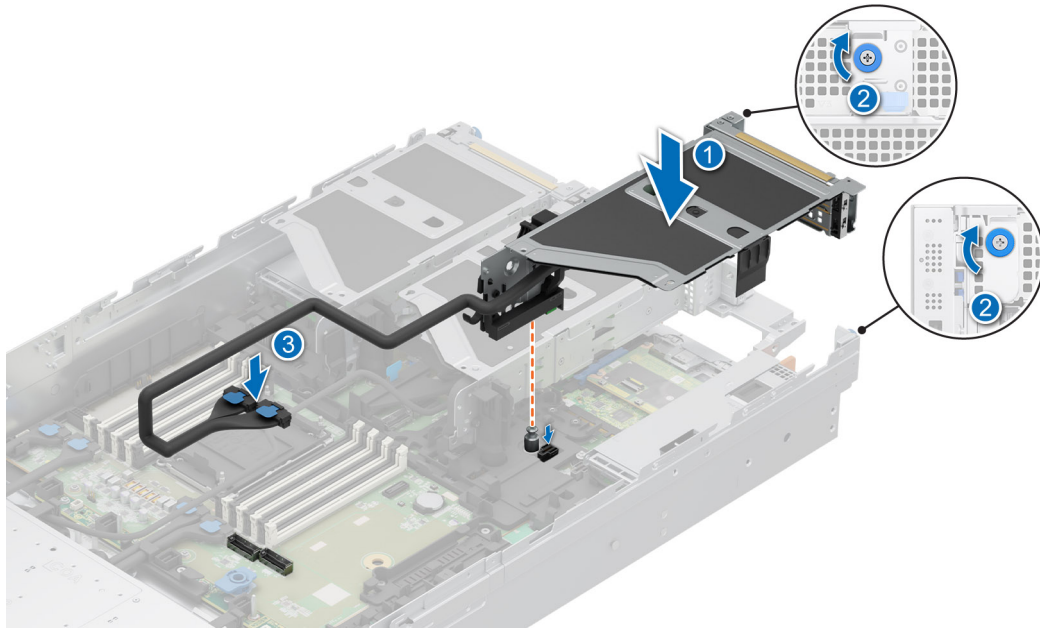

Figure 159. Installing the expansion card riser 1

Next steps

1. If required, reconnect the cables to the expansion card or HPM board.
2. Follow the procedure listed in [After working inside your system](#).

Removing an expansion card from the expansion card riser

Prerequisites

1. Follow the safety guidelines listed in the [Safety instructions](#).
2. Follow the procedure listed in [Before working inside your system](#).
3. [Remove the system cover](#)
4. If applicable, disconnect the cables from the expansion card.
5. [remove the rear expansion card riser](#).

Steps

1. From riser 1 or riser 5 card:
 - a. Tilt the expansion card retention latch lock to open.
 - b. Pull the card holder before removing the card from the riser.
 - c. Hold the expansion card by the edges and pull the card from the riser.

NOTE: The numbers on the image do not depict the exact steps. The numbers are for representation of sequence.

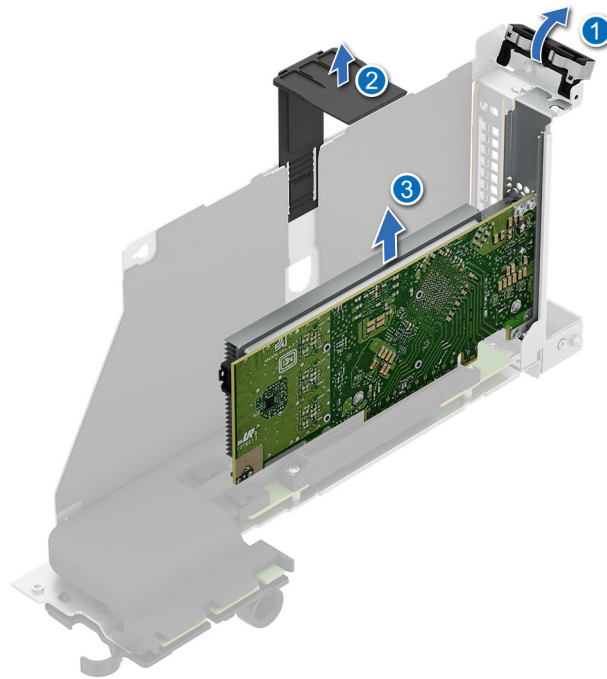

Figure 160. Removing expansion card from the rear expansion card riser

- d. If the expansion card is not going to be replaced on then riser, install a filler bracket and close the card holder on both ends of the riser.
 - i** **NOTE:** You must install a filler bracket over an empty expansion card slot to maintain Federal Communications Commission (FCC) certification of the system. The filler bracket also keeps dust and dirt out of the system and aid in proper cooling and airflow inside the system.

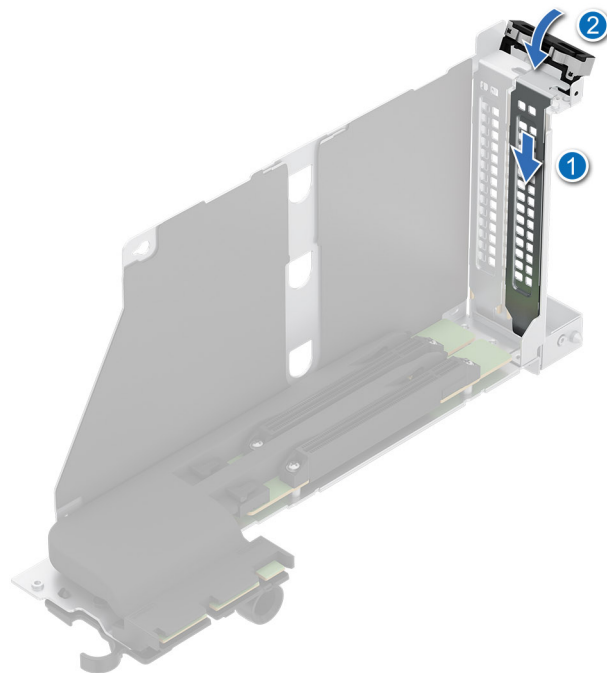

Figure 161. Installing the filler bracket

- 2. OCP NIC card from riser 3:

- a. Press and remove the cover latch from the riser.

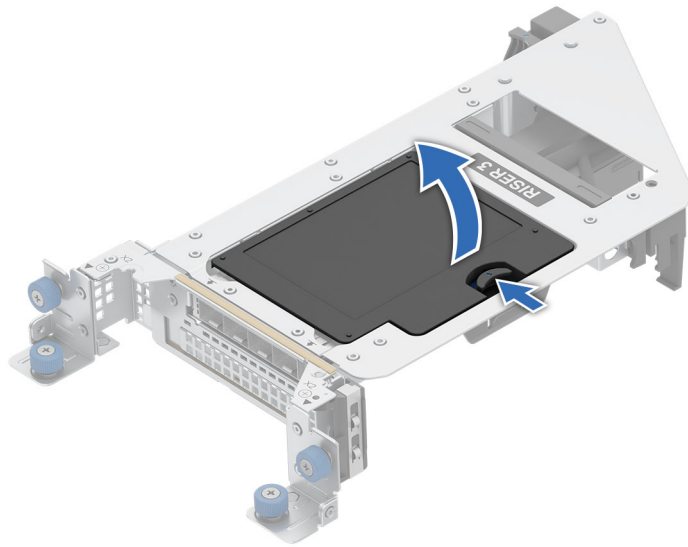

Figure 162. Removing an OCP NIC cover from the riser 3

- b. Open the blue latch to disengage the OCP NIC card.
- c. Push and slide out the OCP NIC card from the rear end of the riser.

NOTE: The numbers on the image do not depict the exact steps. The numbers are for representation of sequence.

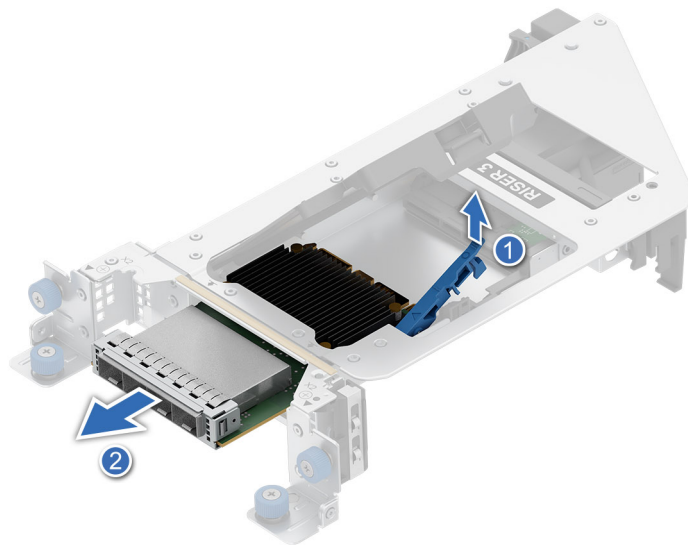

Figure 163. Removing an OCP NIC card from the riser 3

3. From riser 2:
 - a. Tilt the card holder on both ends of the riser.
 - b. Hold the expansion card by the edges and pull the card from the riser.

NOTE: The numbers on the image do not depict the exact steps. The numbers are for representation of sequence.

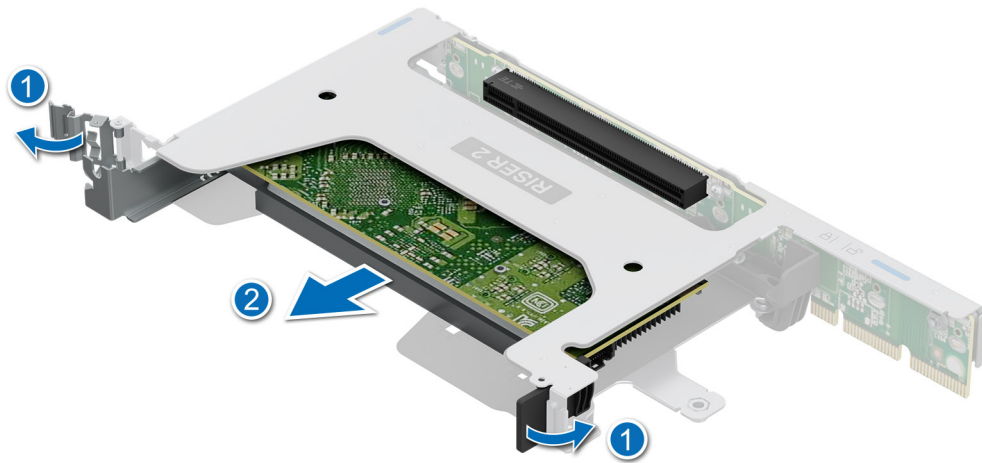

Figure 164. Removing expansion card from the riser 2

- c. If the expansion card is not going to be replaced on then riser, install a filler bracket and close the card holder on both ends of the riser.

NOTE: You must install a filler bracket over an empty expansion card slot to maintain Federal Communications Commission (FCC) certification of the system. The filler bracket also keeps dust and dirt out of the system and aid in proper cooling and airflow inside the system.

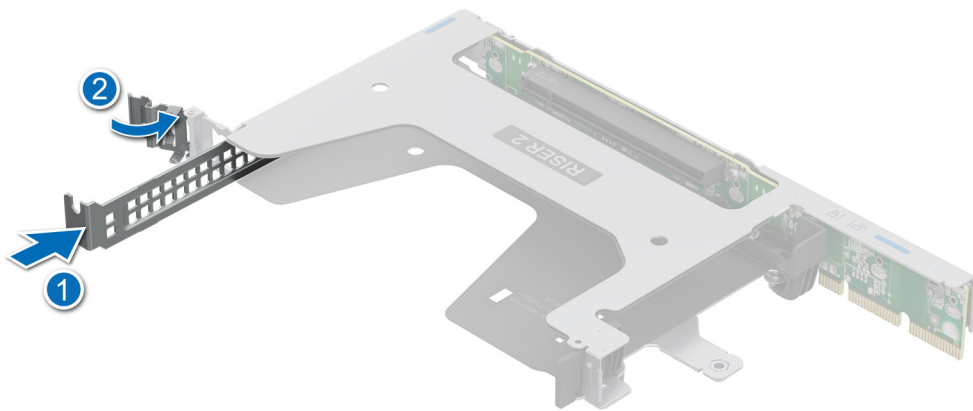

Figure 165. Installing the filler bracket

4. From riser 4:
- Tilt the card holder on both ends of the riser.
 - Hold the expansion card by the edges and pull the card from the riser.

NOTE: The numbers on the image do not depict the exact steps. The numbers are for representation of sequence.

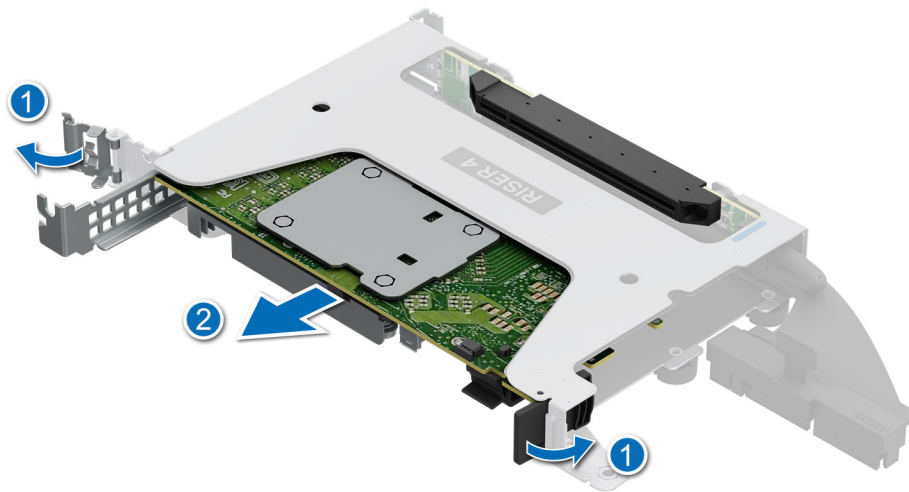

Figure 166. Removing the expansion card from the riser 4

- c. If the expansion card is not going to be replaced on then riser, install a filler bracket or PCIe blank and close the card holder on both ends of the riser.

NOTE: A PCIe blank must be put in riser 4 to balance the airflow for the rear OCP NIC card.

NOTE: You must install a filler bracket over an empty expansion card slot to maintain Federal Communications Commission (FCC) certification of the system. The filler bracket also keeps dust and dirt out of the system and aid in proper cooling and airflow inside the system.

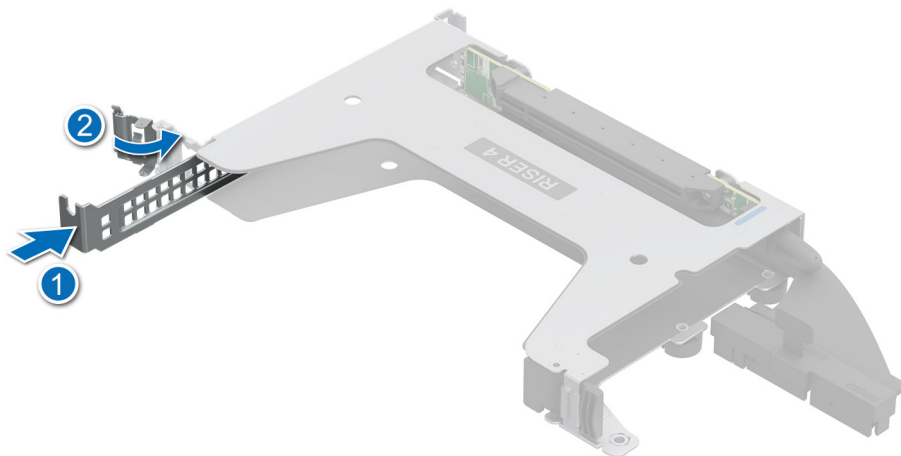

Figure 167. Installing the filler bracket



Figure 168. Installing the PCIe blank

Next steps

If applicable, install an expansion card into the expansion card riser.

Installing an expansion card into the expansion card riser

Prerequisites

1. Follow the safety guidelines listed in the [Safety instructions](#).
2. Follow the procedure listed in [Before working inside your system](#).
3. [Remove the system cover](#)
4. If applicable, disconnect the cables from the expansion card.
5. [remove the rear expansion card riser](#).
6. If installing a new expansion card, unpack it and prepare the card for installation.

NOTE: For instructions, see the documentation accompanying the card.

CAUTION: Do not install GPUs, network cards, or other PCIe devices on your system that are not validated and tested by Dell. Damage caused by unauthorized and invalidated hardware installation will null and void the system warranty.

Steps

1. Into riser 4:
 - a. Tilt the card holder on both ends and slide out the filler bracket or PCIe blank from the riser.

NOTE: Store the filler bracket or PCIe blank for future use. Filler bracket or PCIe blank must be installed in empty expansion card slots to maintain Federal Communications Commission (FCC) certification of the system. The blank also keep dust and dirt out of the system and aid in proper cooling and airflow inside the system.

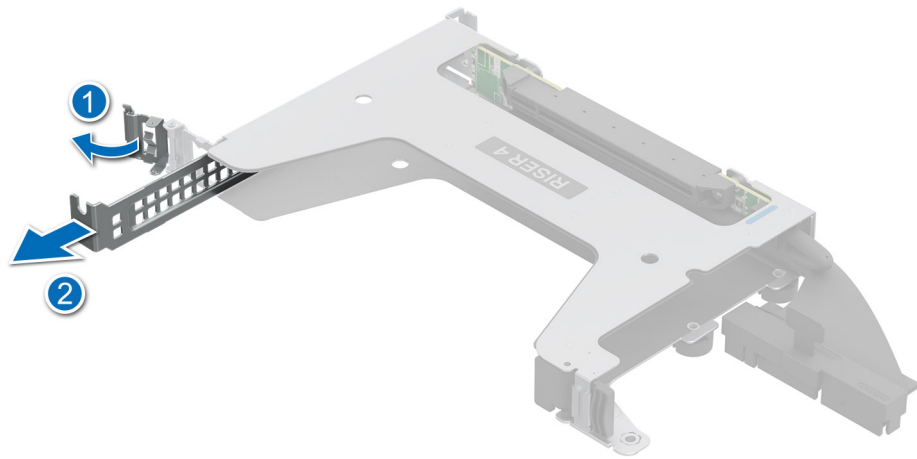

Figure 169. Removing the filler bracket

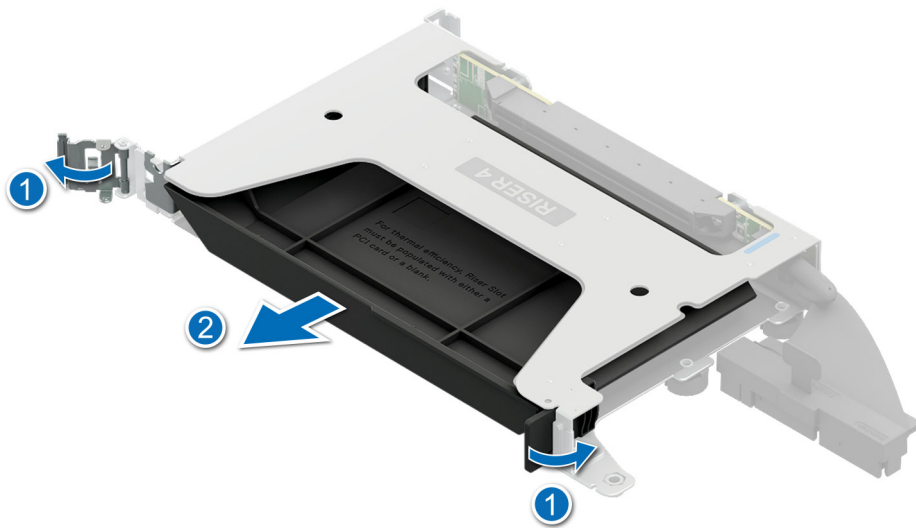

Figure 170. Removing the PCIe blank

- b. Hold the card by edges, and align the card with the connector on the riser.
- c. Insert the card firmly into the expansion card connector until seated.

NOTE: The numbers on the image do not depict the exact steps. The numbers are for representation of sequence.

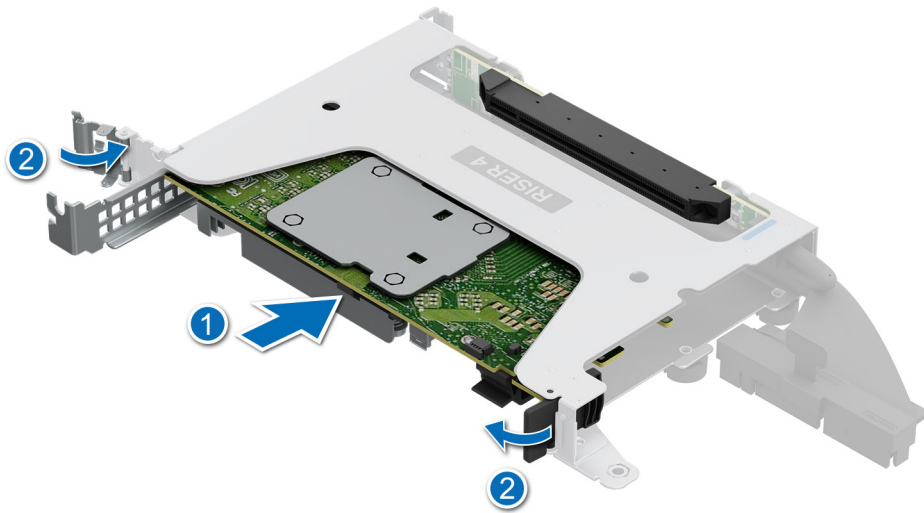

Figure 171. Installing expansion card into the riser 4

- d. Align and slide the card holder guides into the slots on the riser until seated.
- e. Close the card holder on both ends of the riser.

i **NOTE:** The numbers on the image do not depict the exact steps. The numbers are for representation of sequence.

2. Into riser 2:

- a. Tilt the card holder on both ends and slide out the filler bracket from the riser.

i **NOTE:** Store the filler bracket for future use. The filler bracket must be installed in empty expansion card slots to maintain Federal Communications Commission (FCC) certification of the system. The blank also keep dust and dirt out of the system and aid in proper cooling and airflow inside the system.

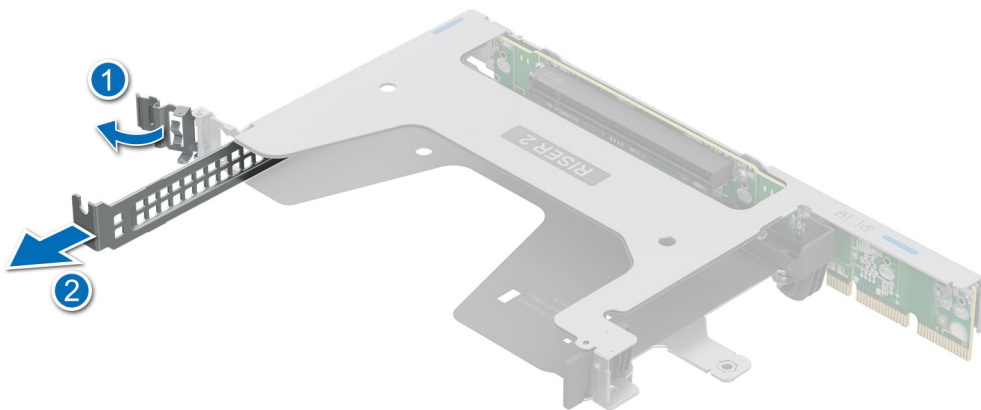

Figure 172. Removing the filler bracket

- b. Hold the card by edges, and align the card with the connector on the riser.
- c. Insert the card firmly into the expansion card connector until seated.
- d. Close the card holder on both ends of the riser.

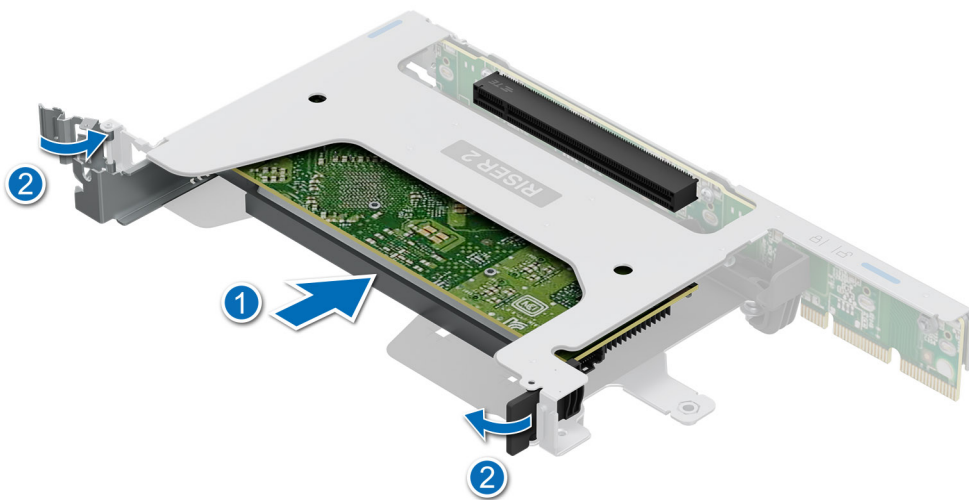

Figure 173. Installing expansion card into the riser 2

- e. Align and press the card holder into the slot on the riser until seated.
- 3. Into riser 1 or riser 5:
 - a. Tilt the card holder and slide out the filler bracket from the riser.
 - i** **NOTE:** Store the filler bracket for future use. The filler bracket must be installed in empty expansion card slots to maintain Federal Communications Commission (FCC) certification of the system. The blank also keep dust and dirt out of the system and aid in proper cooling and airflow inside the system.



Figure 174. Removing the filler bracket

- b. Tilt the expansion card retention latch lock to open.
- c. Hold the card by edges, and align the card with the connector on the riser.
- d. Insert the card firmly into the expansion card connector until seated.

- e. Tilt the expansion card retention latch to close.
- f. Push the card holder to hold the card in the riser.

NOTE: The numbers on the image do not depict the exact steps. The numbers are for representation of sequence.

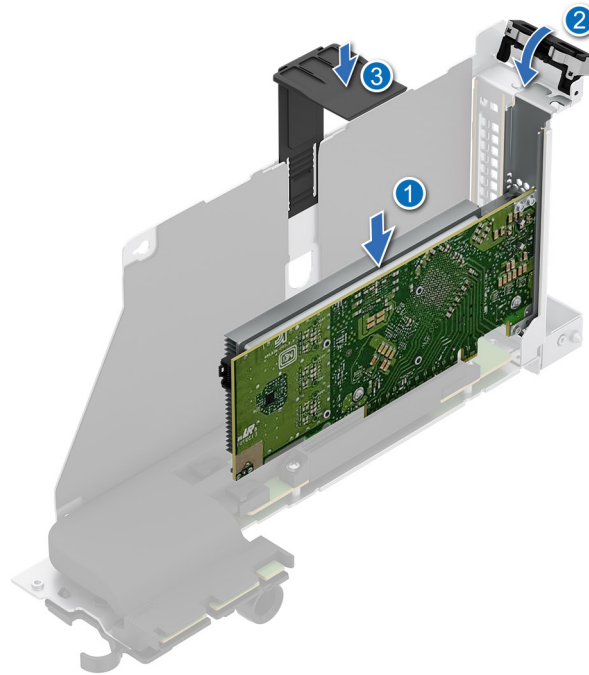

Figure 175. Installing an expansion card into the riser

- 4. OCP NIC card into riser 3:
 - a. Open the blue latch on the riser.
 - b. Slide the OCP NIC card into the riser slot.
 - c. Push until the OCP NIC card is connected to the connector on the riser.
 - d. Close the blue latch to lock the OCP NIC card to the riser.

NOTE: The numbers on the image do not depict the exact steps. The numbers are for representation of sequence.

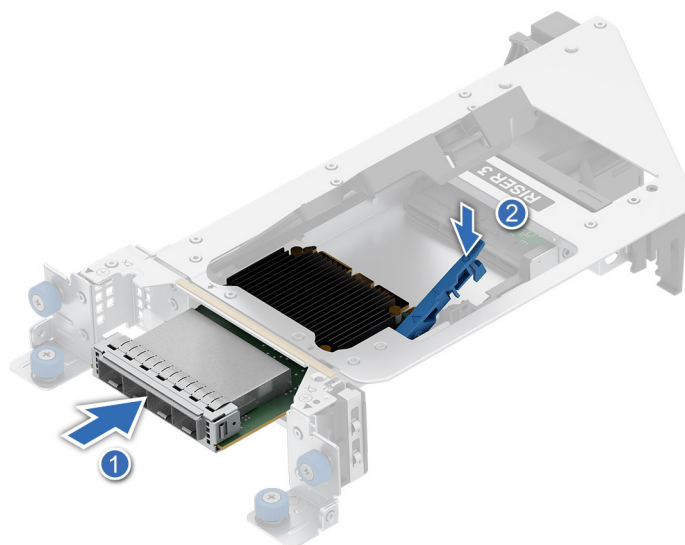

Figure 176. Installing an OCP NIC card into the riser 3

- e. Align and insert the cover latch into the riser.

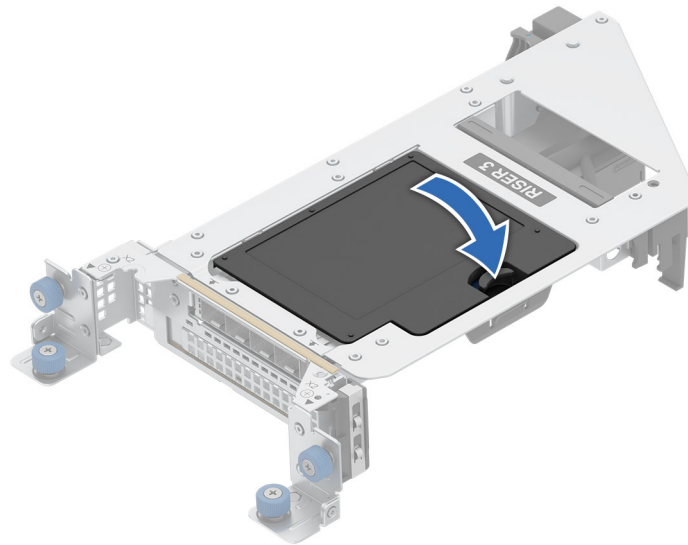

Figure 177. Installing an OCP NIC cover into the riser 3

Next steps

1. If applicable, connect the cables to the expansion card.
2. [install the rear expansion card riser.](#)
3. [Replace the system cover.](#)
4. Follow the procedure listed in the [After working inside your system.](#)
5. Install any device drivers required for the card as described in the documentation for the card.

Removing the rear expansion card riser blank

Prerequisites

1. Follow the safety guidelines listed in the [Safety instructions.](#)
2. Follow the procedure listed in the [Before working inside your system.](#)
3. [Remove the system cover.](#)

Steps

1. Loosen the captive screws on the riser blanks and on the system chassis.
2. Holding the edges lift the expansion card riser blanks out of the system.

NOTE: The numbers on the image do not depict the exact steps. The numbers are for representation of sequence.

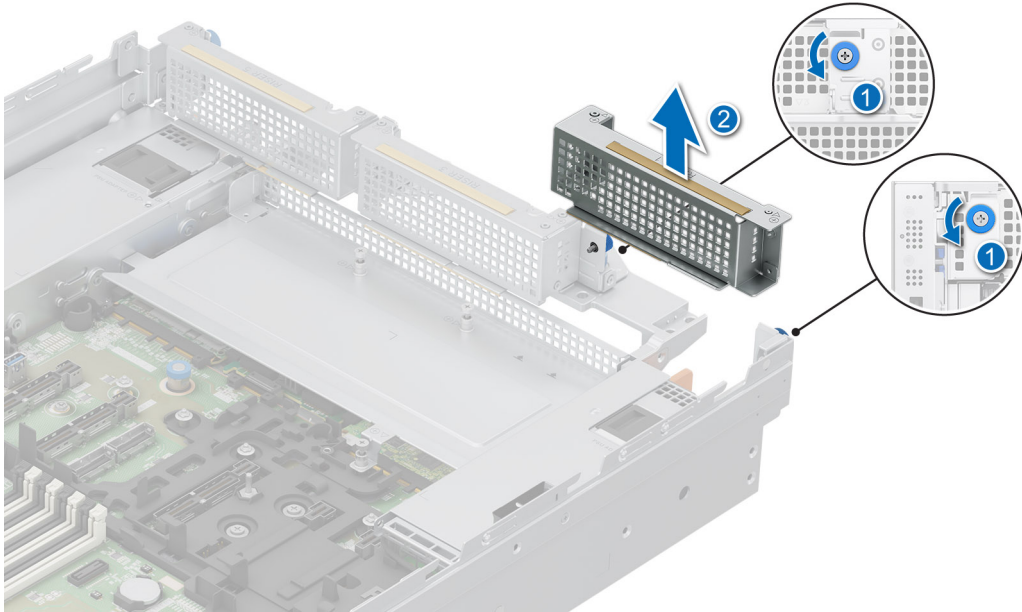

Figure 178. Removing the rear expansion card riser 1 blank

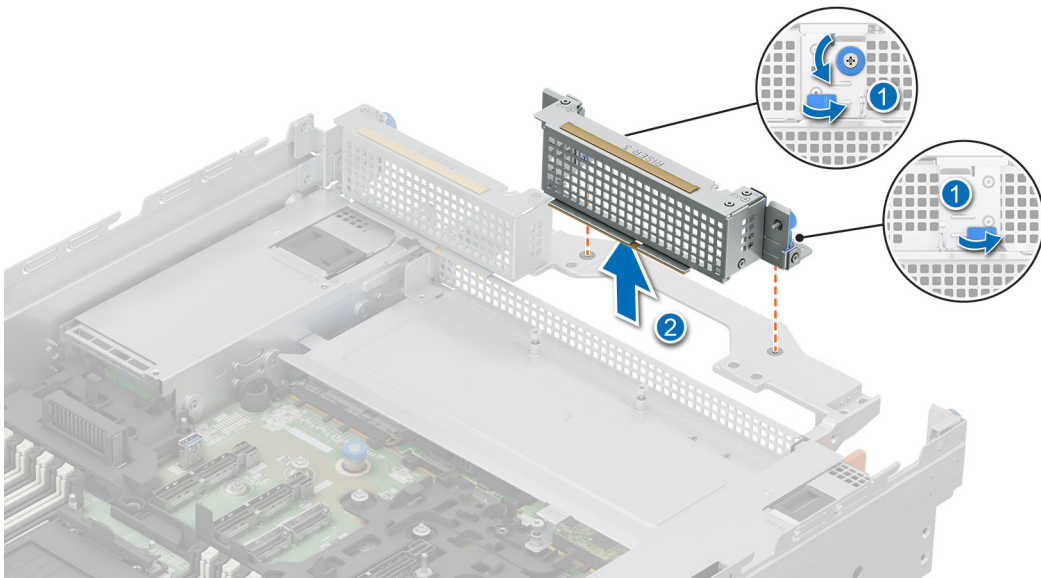

Figure 179. Removing the rear expansion card riser 3 blank

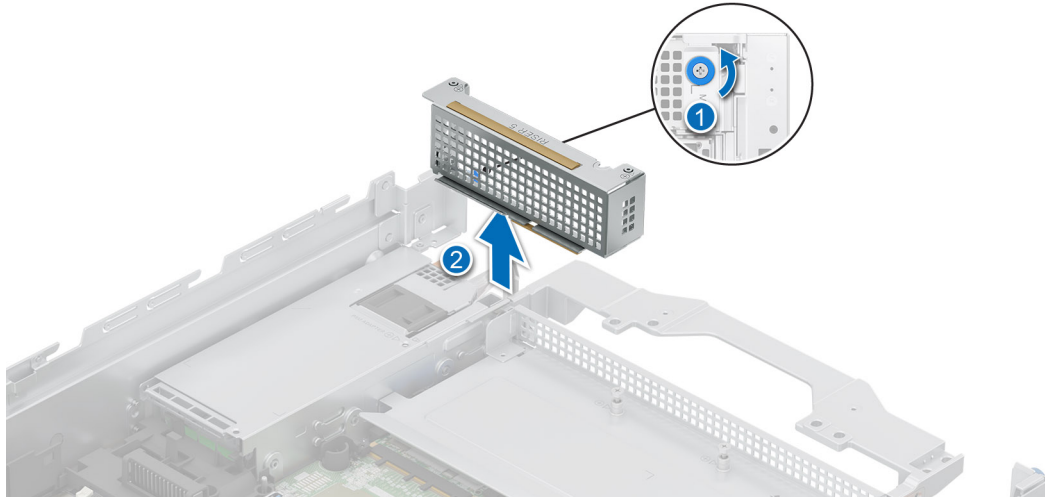

Figure 180. Removing the rear expansion card riser 5 blank

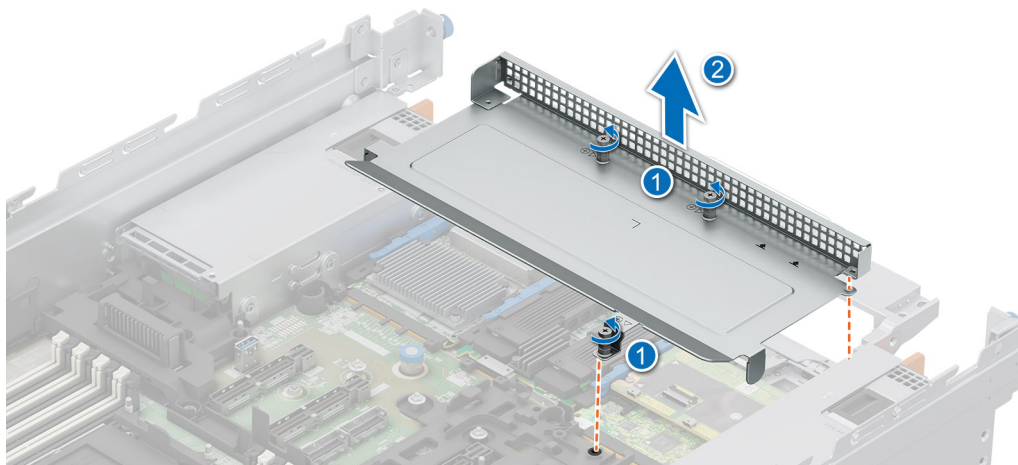

Figure 181. Removing the expansion card riser 4 and riser 2 blank

NOTE: The number of screws that need to be removed on Riser 2 Blank depends on the type of blanks being used.

Next steps

1. [Replace the rear expansion card risers](#)

Installing the rear expansion card riser blank

Prerequisites

1. Follow the safety guidelines listed in the [Safety instructions](#).
2. Follow the procedure listed in the [Before working inside your system](#).
3. [Remove the system cover](#).

Steps

1. Holding the edges align the holes on the expansion card riser blanks with the guides on the system.
2. Lower the expansion card riser blanks into place.
3. Tighten the captive screws on the risers and system.

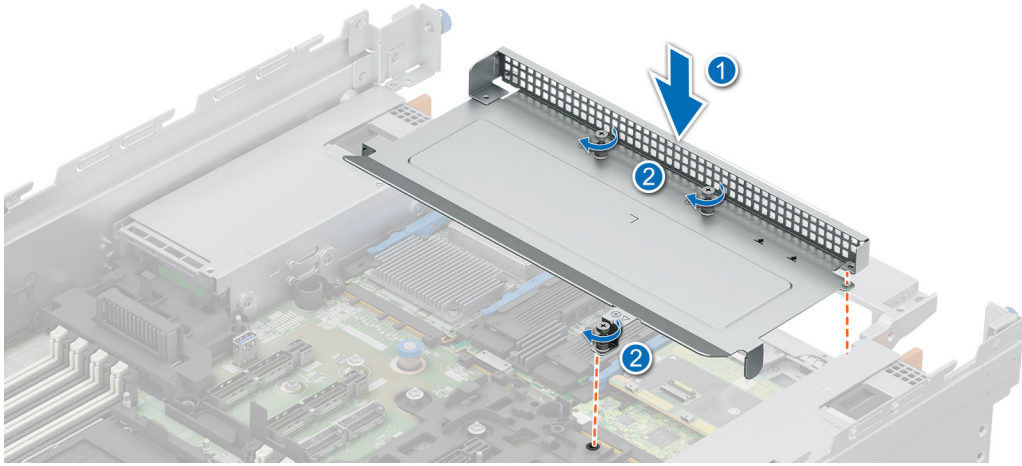

Figure 182. Installing the rear expansion card riser 4 and riser 2 blank

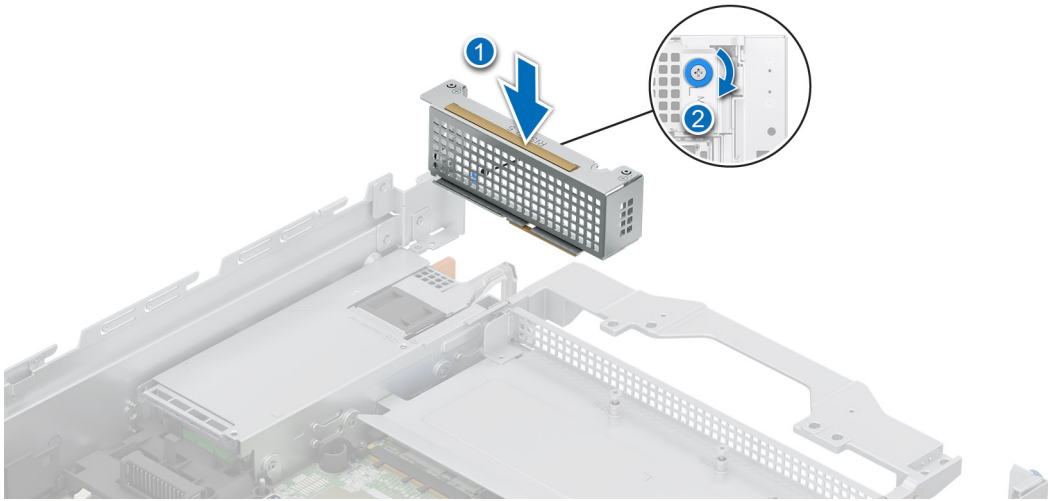

Figure 183. Installing the rear expansion card riser 5 blank

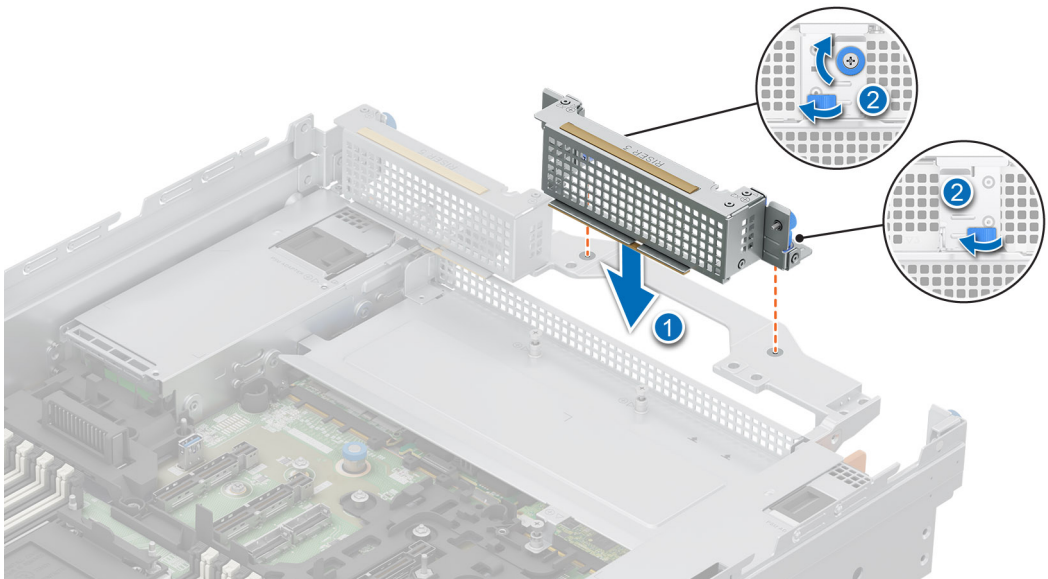

Figure 184. Installing the rear expansion card riser 3 blank

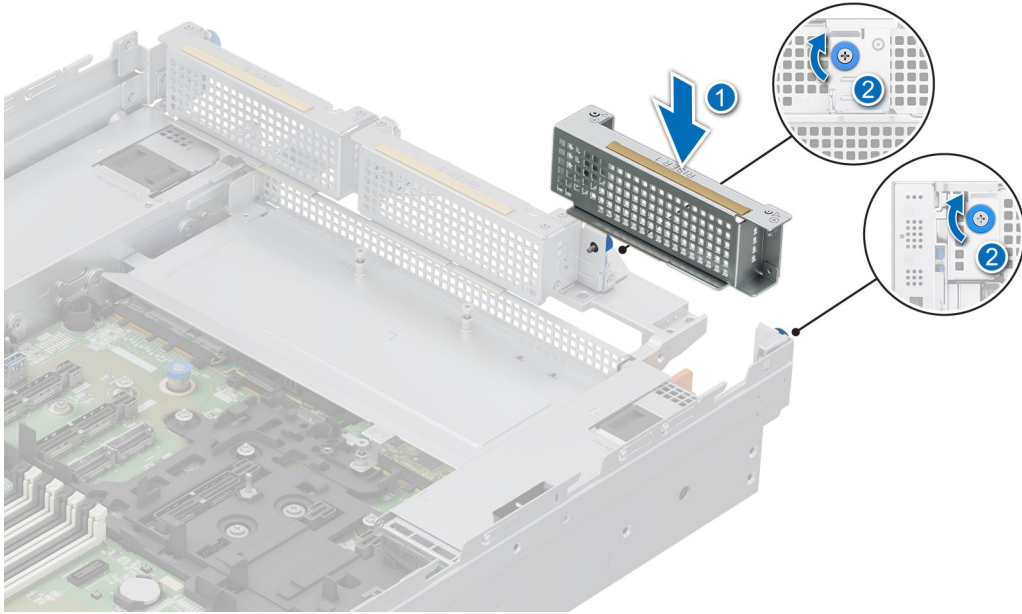

Figure 185. Installing the rear expansion card riser 1 blank

Next steps

1. [Replace the system cover.](#)
2. Follow the procedure listed in [After working inside your system.](#)

M.2 SSD module

Removing the M.2 NVMe SSD module

Prerequisites

1. Follow the safety guidelines listed in the [Safety instructions.](#)
2. Follow the procedure listed in [Before working inside your system.](#)

Steps

1. Pull and lift the BOSS-N1 card carrier retention latch lock to open.
2. Slide the BOSS-N1 card carrier out.

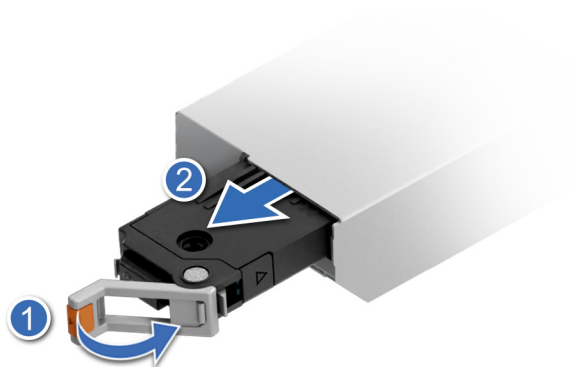

Figure 186. Removing the BOSS-N1 card carrier

- Using the Phillips 1 screwdriver, loosen the captive screws securing the top cover of the BOSS-N1 card carrier.

NOTE: Follow the sequence to loosen the captive screws. First, loosen the screw at the connector end, and then the screw at the front handle end.



Figure 187. Loosen the top cover captive screws

- Tilt the top cover from the side and lift the top cover out of the BOSS-N1 card carrier.



Figure 188. Removing the top cover

- Lift the M.2 NVMe SSD module to disconnect from the BOSS-N1 card carrier connector.

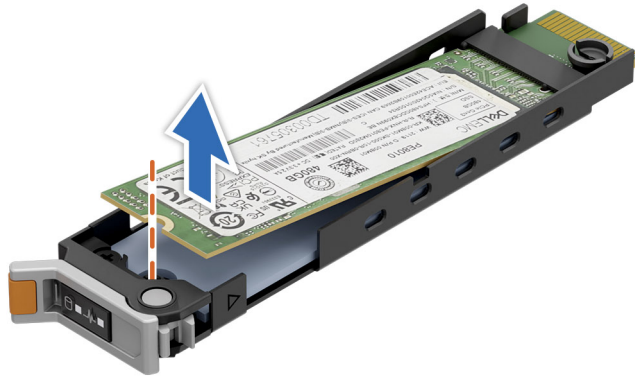

Figure 189. Removing the M.2 NVMe SSD module

NOTE: For information about Thermal pad and BOSS-N1 card carrier replacement, go to [PowerEdge Manuals > Rack Servers > PowerEdge R570 > Select This Product > Documentation > Manuals and Documents > BOSS-N1 DC-MHS M.2 NVMe SSD Card Installation and Replacement Tech Sheet](#).

Next steps

1. [Replace the M.2 NVMe SSD module.](#)

Installing the M.2 NVMe SSD module

Prerequisites

1. Follow the safety guidelines listed in the [Safety instructions](#).
2. Follow the procedure listed in [Before working inside your system](#).
3. Replace the thermal pads on the top and bottom cover of the BOSS-N1 card carrier, when replacing the M.2 NVMe SSD module.

NOTE: For information about Thermal pad and BOSS-N1 card carrier replacement, go to [PowerEdge Manuals > Rack Servers > PowerEdge R570 > Select This Product > Documentation > Manuals and Documents > BOSS-N1 DC-MHS M.2 NVMe SSD Card Installation and Replacement Tech Sheet](#).

Steps

1. Align the M.2 NVMe SSD module at an angle with the BOSS-N1 card carrier connector.
2. Insert the M.2 NVMe SSD module until it is firmly seated in the BOSS-N1 card carrier connector.

NOTE: Press the M.2 NVMe SSD card until it adheres to the thermal pad.

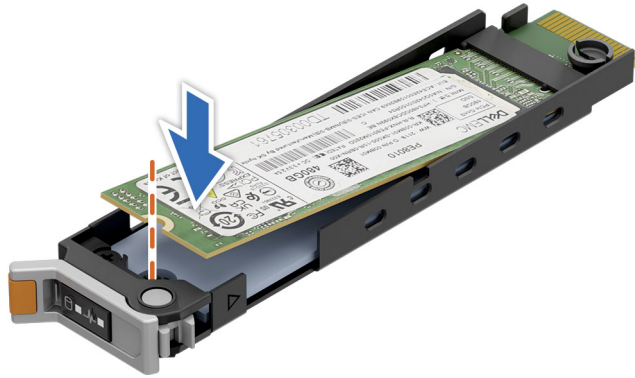

Figure 190. Installing the M.2 NVMe SSD module

3. Align at an angle, place the top cover hook into the slot on the bottom cover of the BOSS-N1 card carrier.
4. Press the opposite side of the top cover until firmly seated.

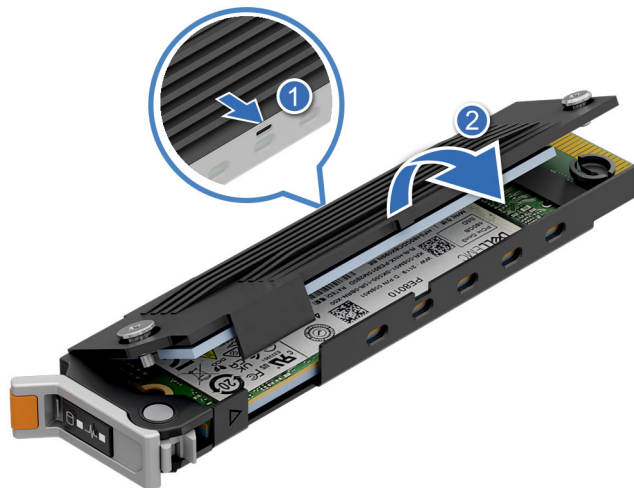

Figure 191. Installing the top cover

5. Using the Phillips 1 screwdriver, tighten the captive screws on the BOSS-N1 card carrier top cover.
i **NOTE:** Follow the sequence to tighten the captive screws. First, tighten the screw available at the front handle end, and then the screw at the connector end.



Figure 192. Tighten the top cover captive screws

6. Slide the BOSS-N1 card carrier into the BOSS-N1 module slot.
7. Close the BOSS-N1 card carrier release latch to lock the carrier in place.

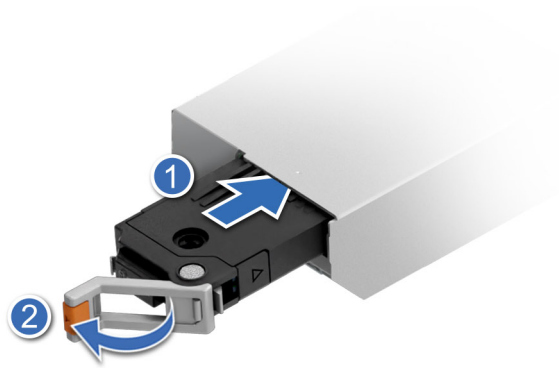

Figure 193. Installing the BOSS-N1 card carrier

Removing the M.2 NVMe SSD module from the M.2 Interposer board

Prerequisites

1. Follow the safety guidelines listed in the [Safety instructions](#).
2. Follow the procedure listed in [Before working inside your system](#).
3. [Remove the M.2 Interposer board](#) .

Steps

1. Using the Phillips 1 screwdriver, loosen the captive screws securing the top cover of the M.2 Interposer board. Tilt the top cover from the side and lift the top cover out of the M.2 Interposer board.

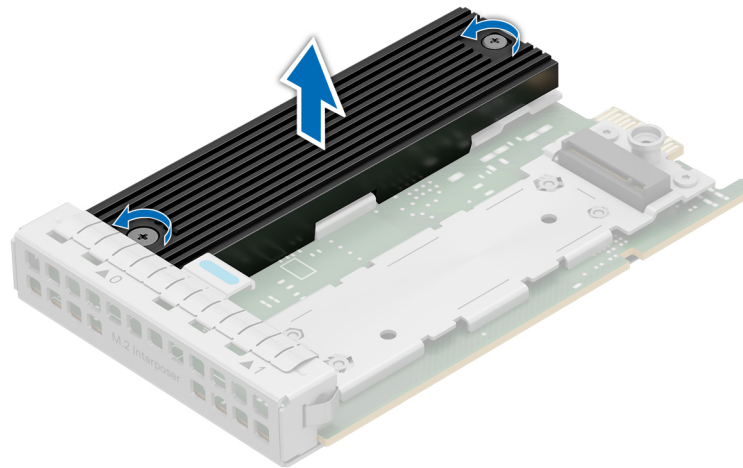

Figure 194. Loosen the top cover captive screws

2. Lift the M.2 NVMe SSD module to disconnect from the M.2 Interposer board.

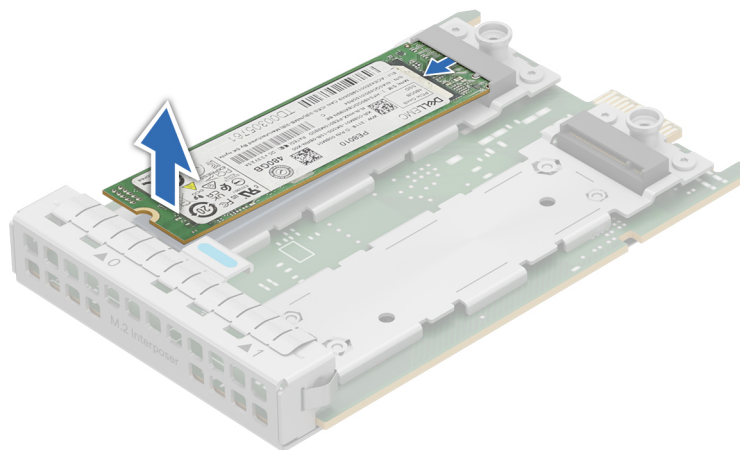

Figure 195. Removing the M.2 NVMe SSD from the board

Next steps

1. Replace the M.2 NVMe SSD module in the M.2 Interposer board.

Installing the M.2 NVMe SSD module in the M.2 Interposer board

Prerequisites

1. Follow the safety guidelines listed in the [Safety instructions](#).
2. Follow the procedure listed in [Before working inside your system](#).
3. [Remove the M.2 Interposer board](#) .

Steps

1. Remove the thermal pads on the top cover and bottom cover of the M.2 Interposer board, when replacing the M.2 NVMe SSD module in the M.2 Interposer board.

NOTE: The thermal pad that has been removed cannot be reused for installing the M.2 NVMe SSD module. You must use new thermal pads for the installation.

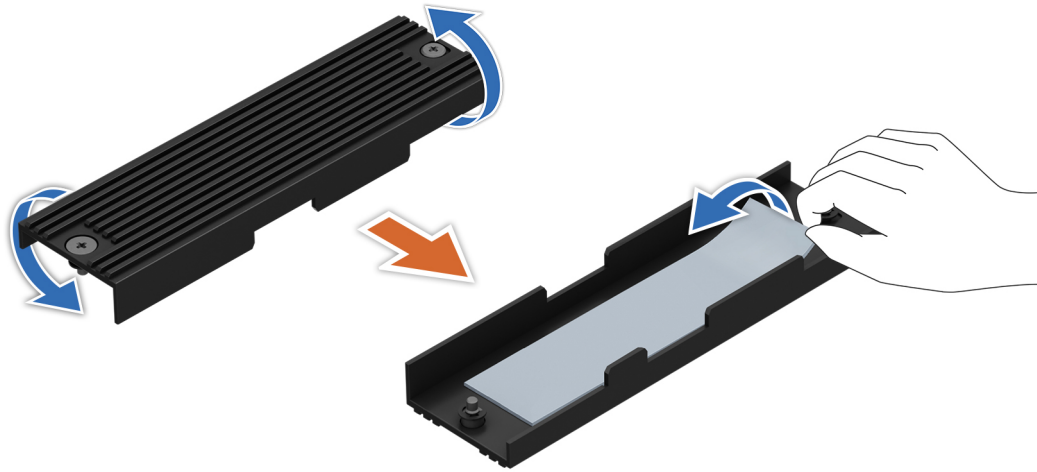

Figure 196. Removing the thermal pad from the top cover

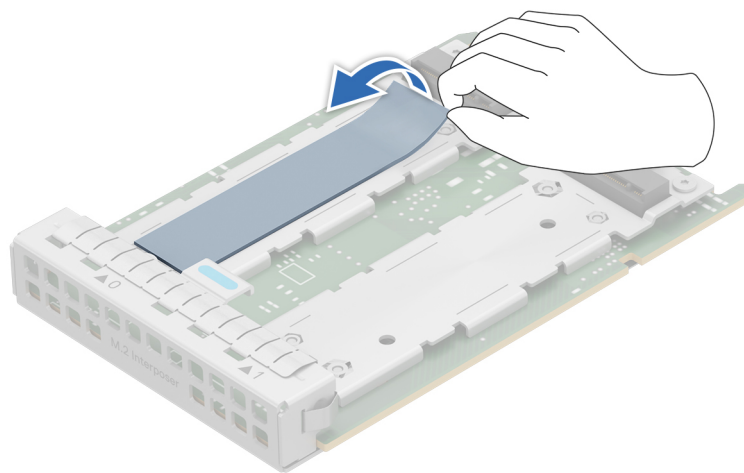

Figure 197. Removing the thermal pad from the board from the slot0

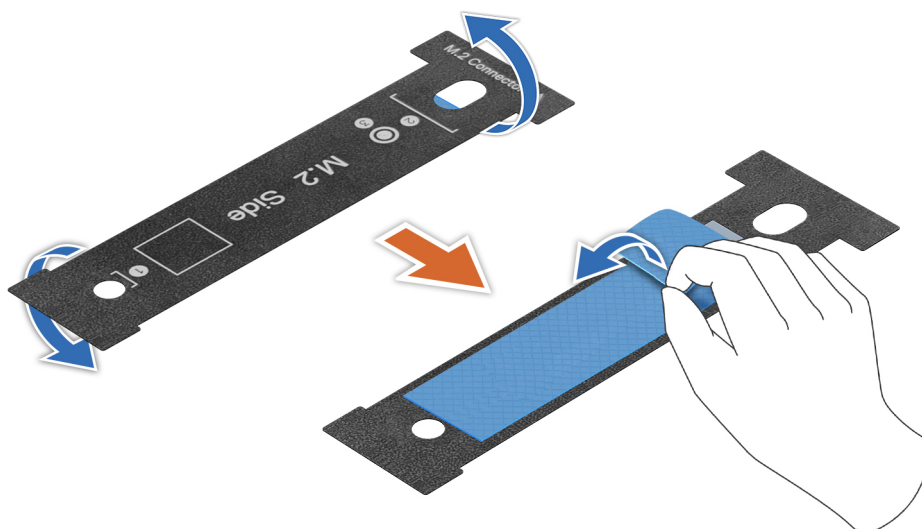

Figure 198. Removing the blue film from the new thermal pad

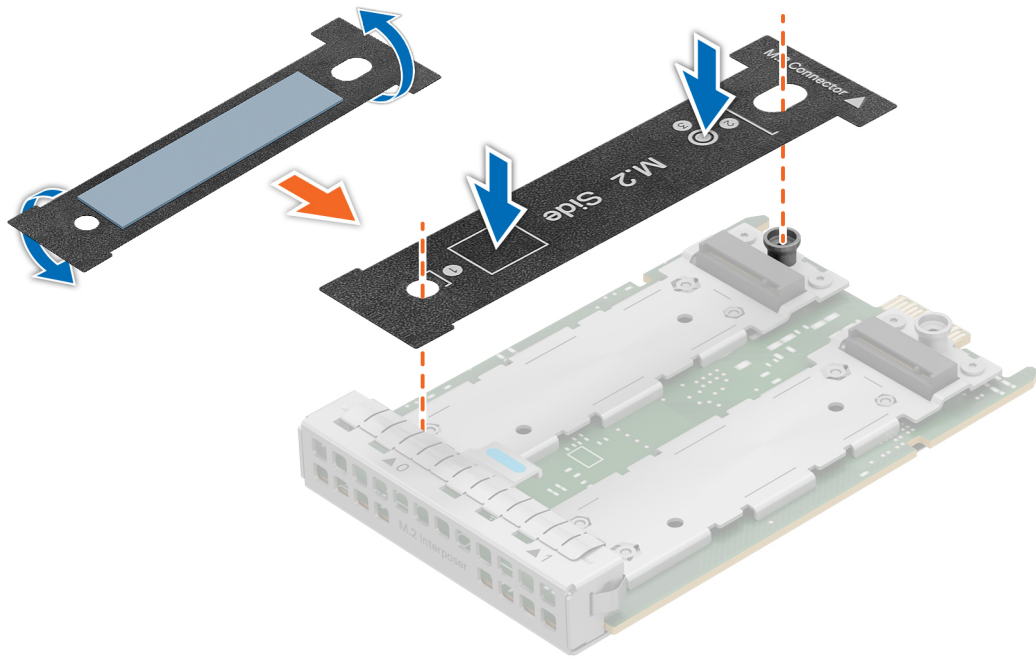

Figure 199. Flipping and installing the new thermal pad on the board

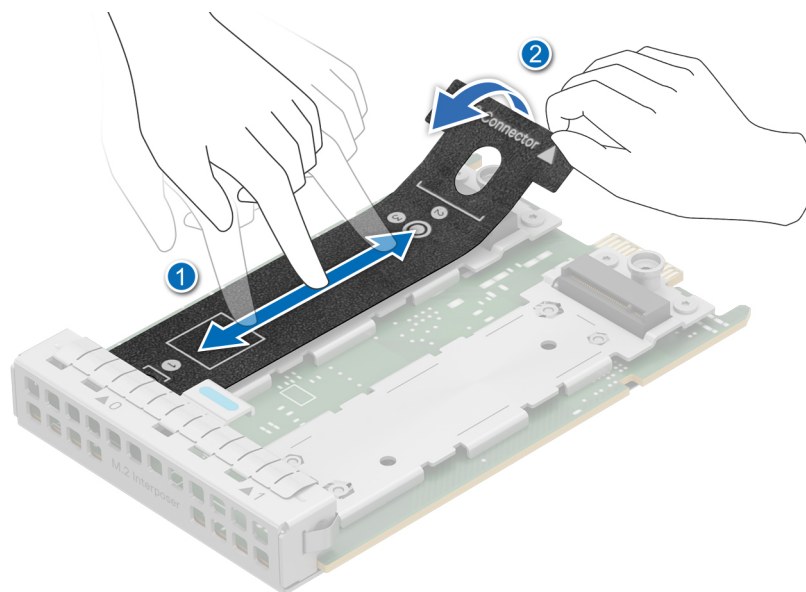

Figure 200. Pasting the new thermal pad on the board and removing the black mylar

2. Align the M.2 NVMe SSD module at an angle with the M.2 Interposer board.
3. Insert the M.2 NVMe SSD module until it is firmly seated in the M.2 Interposer board.

NOTE: Press the M.2 NVMe SSD module until it adheres to the thermal pad.

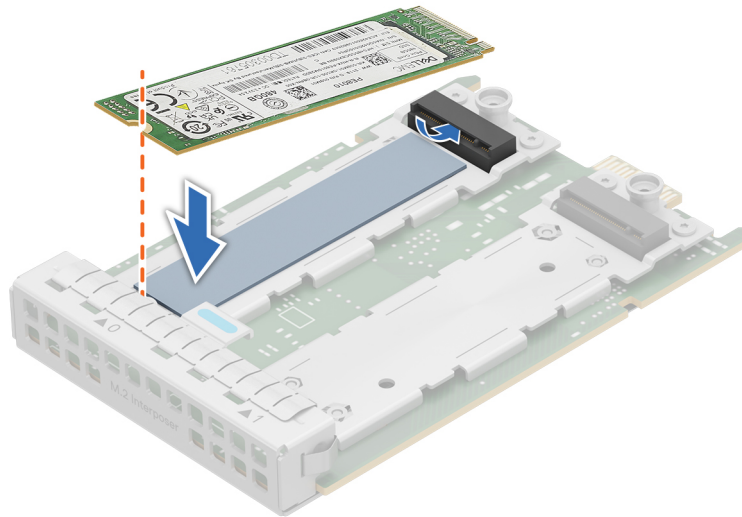

Figure 201. Installing the new M.2 NVMe SSD module

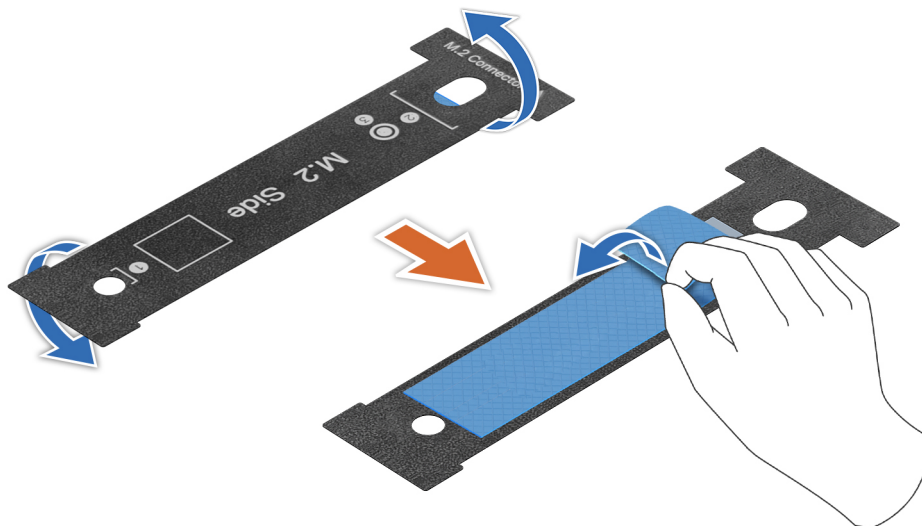

Figure 202. Removing the blue film from another thermal pad

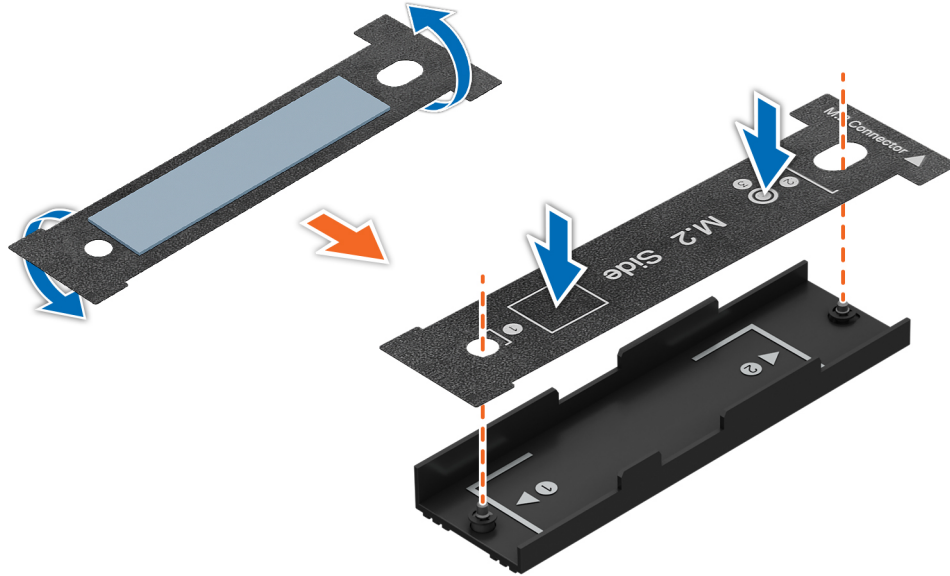

Figure 203. Installing the new thermal pad inside the top cover

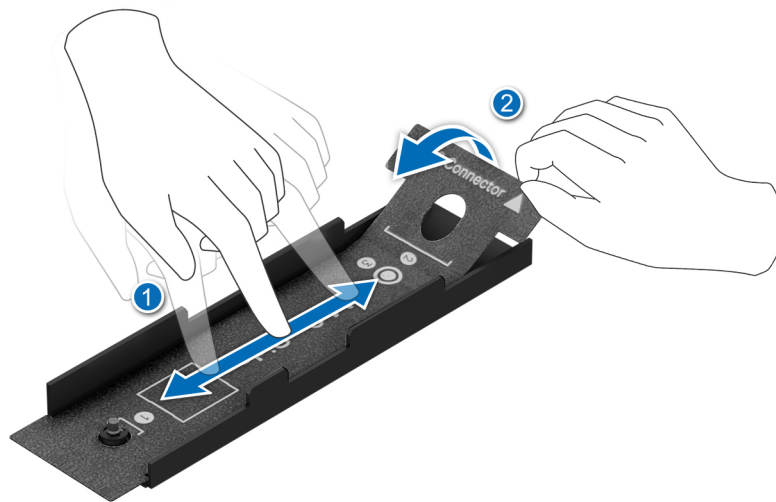

Figure 204. Pasting the new thermal pad inside the top cover and removing the black mylar from the thermal pad

4. Flip the top cover and install it on the M.2 Interposer board. Using the Phillips 1 screwdriver, tighten the captive screws on the M.2 Interposer board top cover.

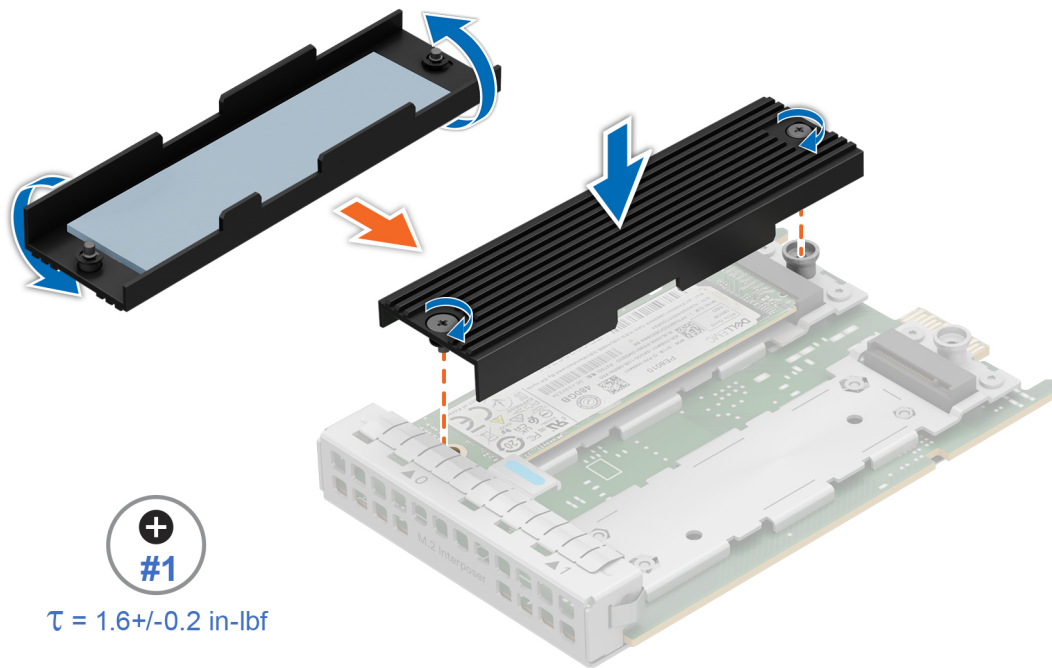

Figure 205. Installing the top cover

Optional M.2 Interposer board

This is a service technician replaceable part only.

Removing the M.2 Interposer board

Prerequisites

1. Follow the safety guidelines listed in the [Safety instructions](#).
2. Follow the procedure listed in the [Before working inside your system](#).
3. [Remove the rear expansion card riser](#) or [remove the rear expansion card riser blanks](#).

Steps

1. Open the blue latch to disengage the M.2 Interposer board.
2. Press and hold the push point on the card to push the M.2 Interposer board towards the rear of the system, disconnecting it from the connector on the HPM board.
3. Slide the M.2 Interposer board out of the slot on the system.

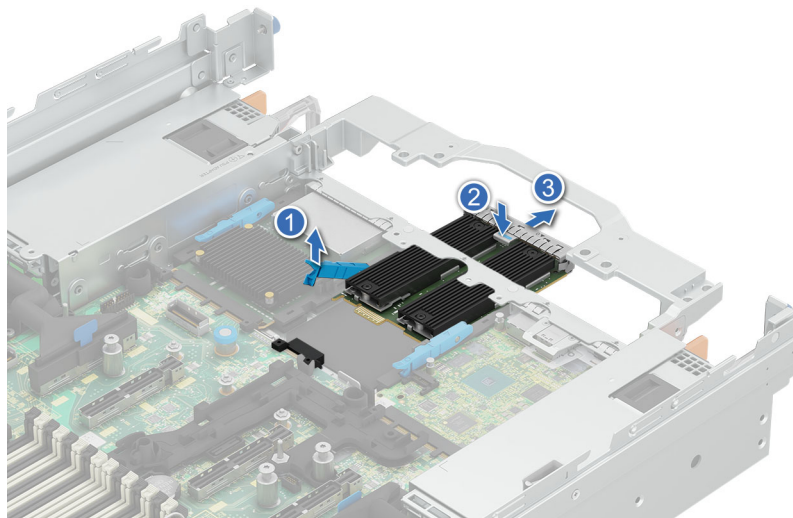

Figure 206. Removing the M.2 Interposer board

4. If you do not plan to replace the M.2 Interposer board, install a filler bracket.

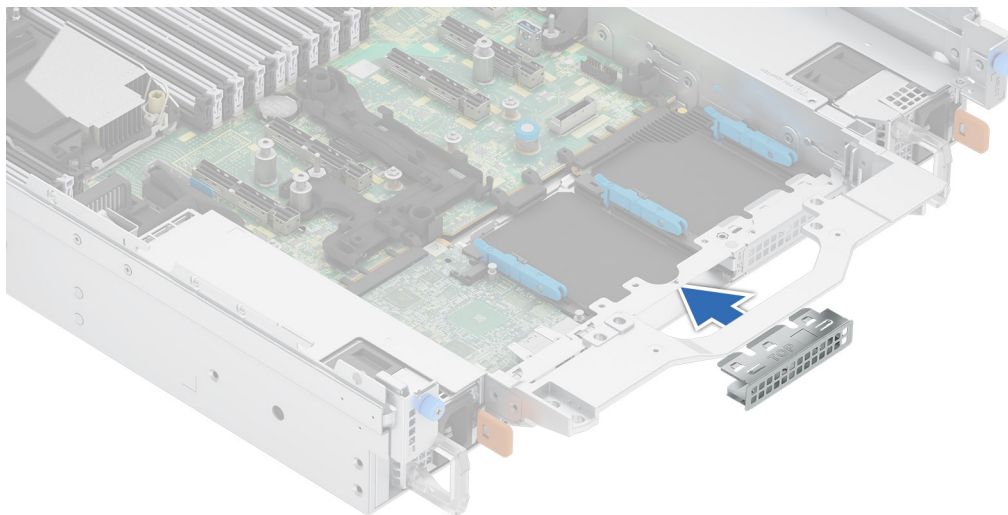

Figure 207. Installation of filler bracket

Next steps

- Remove the M.2 NVMe SSD module from the M.2 Interposer board.

NOTE: If a new M.2 Interposer board is being installed, the M.2 NVMe SSD modules must be removed from the existing M.2 Interposer board and added to the new board.

- Replace the the M.2 Interposer board

Installing the M.2 Interposer board

Prerequisites

1. Follow the safety guidelines listed in the [Safety instructions](#).
2. Follow the procedure listed in the [Before working inside your system](#).
3. [Remove the rear expansion card riser](#) or [remove the rear expansion card riser blanks](#).

NOTE: If a new M.2 Interposer board is being installed, the M.2 NVMe SSD modules must be removed from the existing M.2 Interposer board and added to the new board.

Steps

1. If installed, remove the filler bracket.

NOTE: Store the filler bracket for future use. Filler brackets must be installed in empty expansion card slots to maintain Federal Communications Commission (FCC) certification of the system. The brackets also keep dust and dirt out of the system and aid in proper cooling and airflow inside the system.

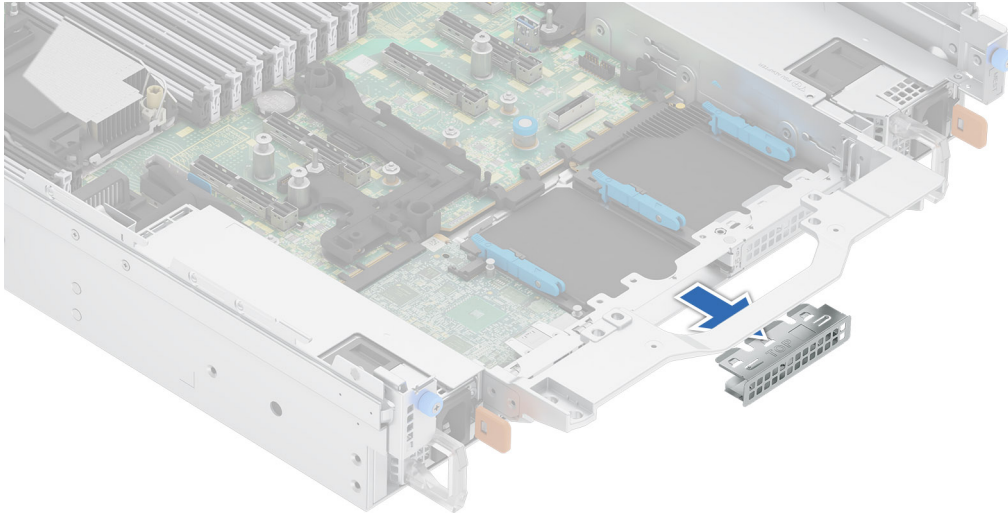

Figure 208. Removal of filler bracket

2. Remove the thermal pads from the top cover and from the bottom of the M.2 Interposer board, when replacing the M.2 Interposer board.

CAUTION: If you are not using the slot 1, peel off the protective film and the thermal pad on the slot 1.

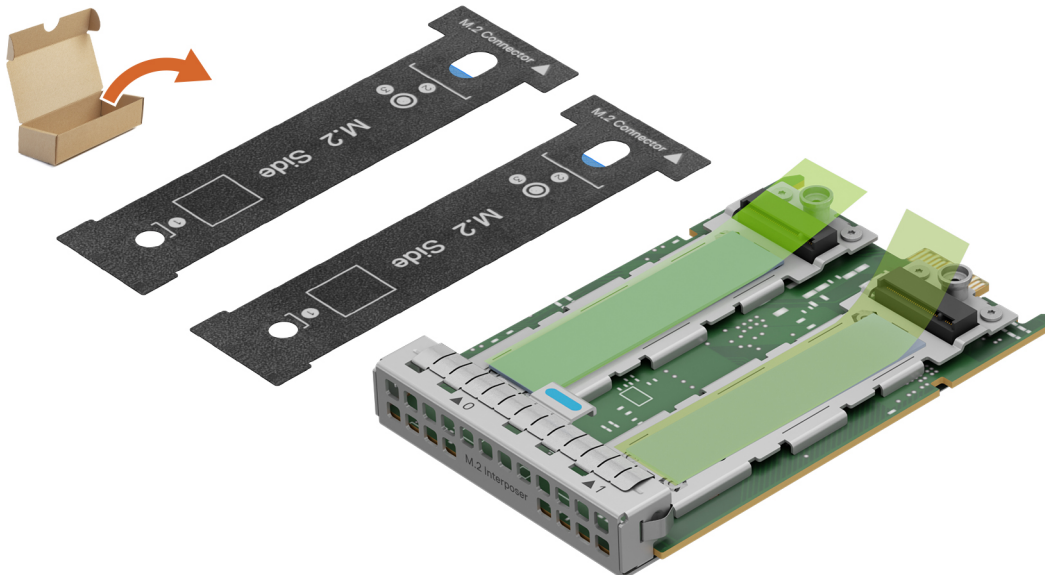

Figure 209. Kit contents

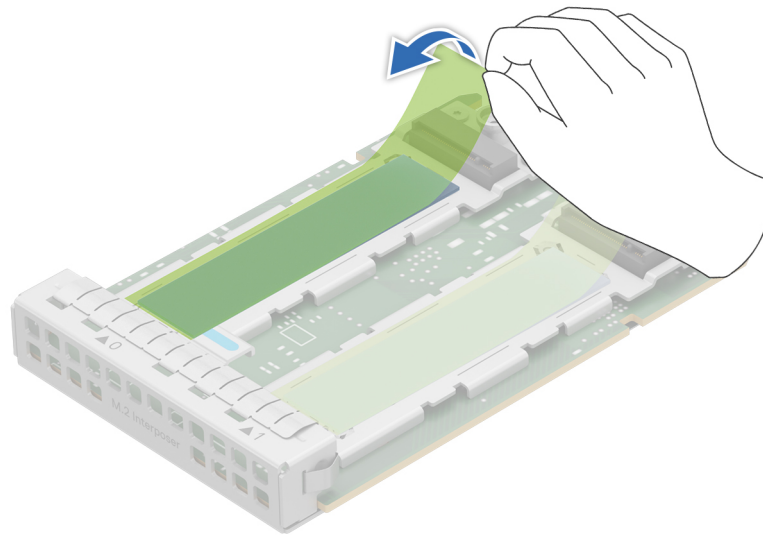

Figure 210. Removing the protective film from the thermal pad

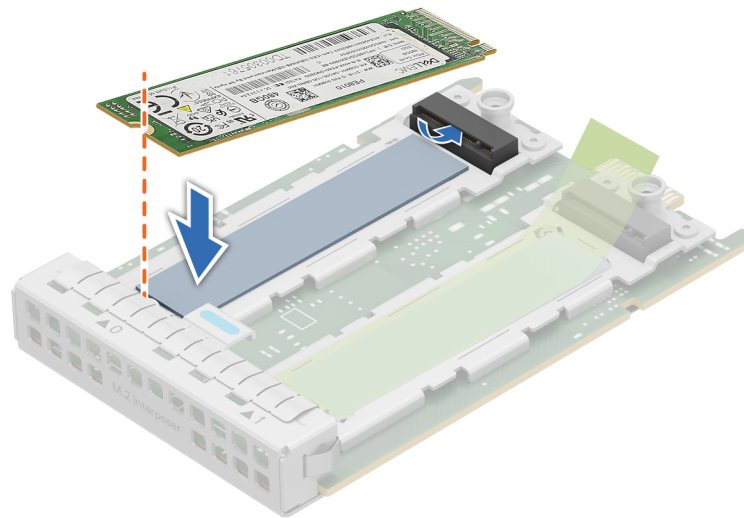

Figure 211. Installing the SSD

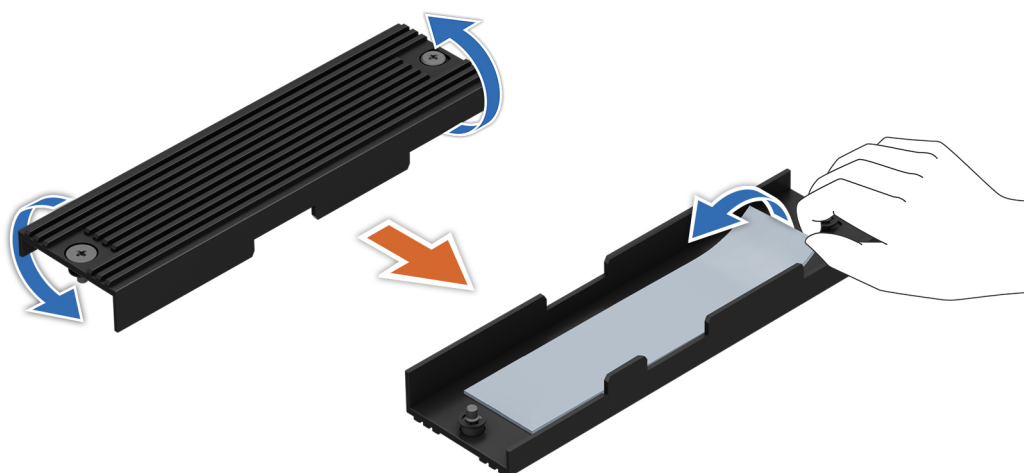

Figure 212. Flipping the top cover and removing the thermal pad from the top cover

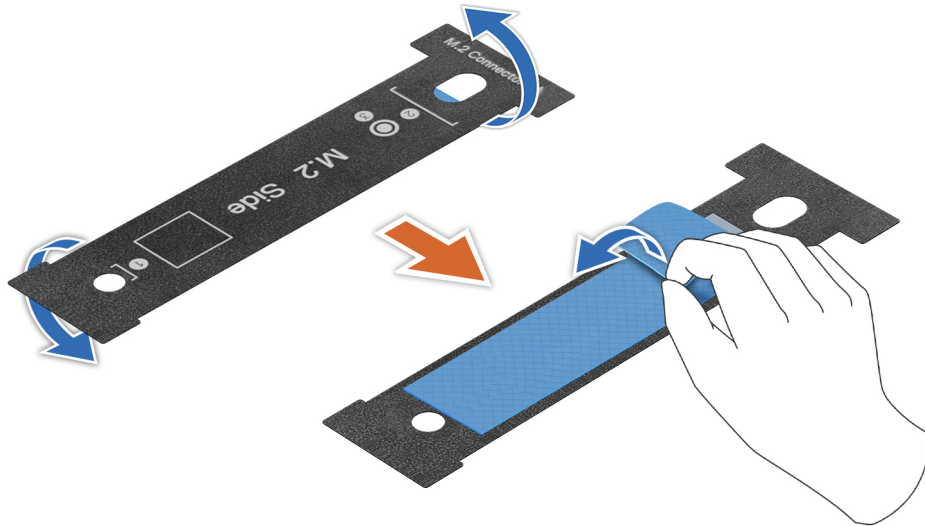

Figure 213. Removing the blue film from the new thermal pad

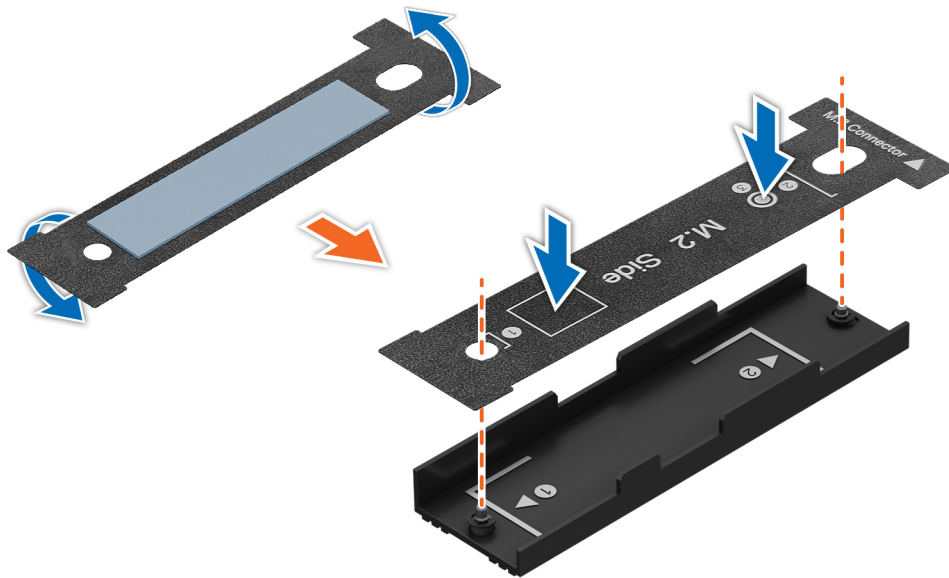

Figure 214. Installing the new thermal pad inside the top cover

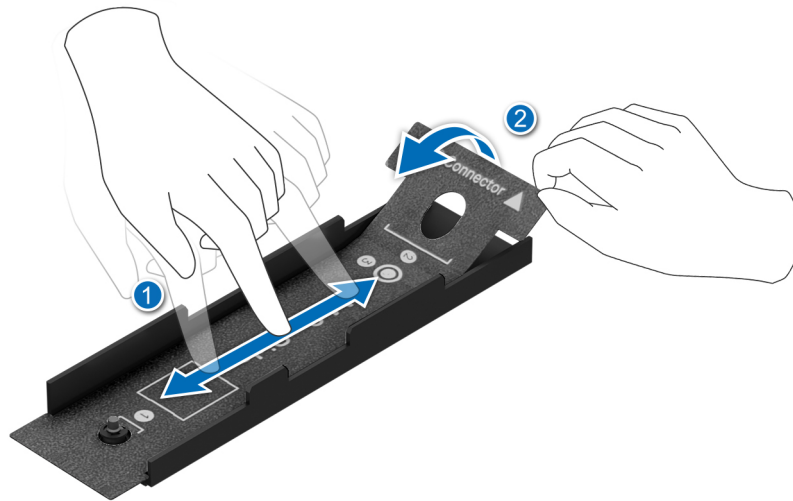

Figure 215. Pasting the new thermal pad inside the top cover and removing the black mylar

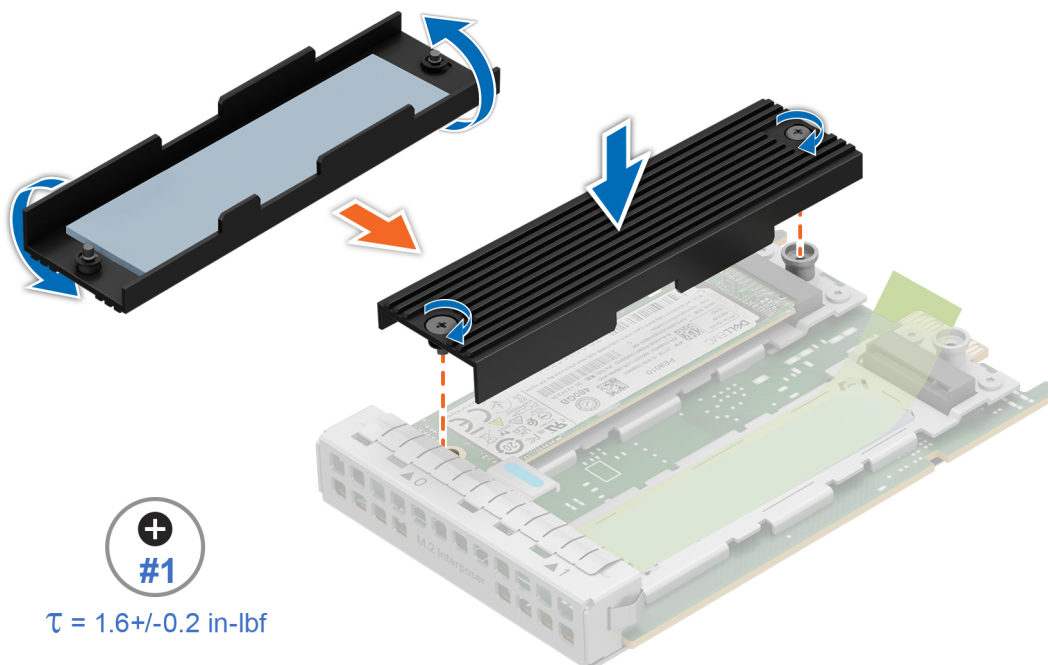

Figure 216. Installing the top cover on the M.2 Interposer board

3. Open the blue latch on the system board.
4. Slide the M.2 Interposer board into the slot in the system.
5. Push until the M.2 Interposer board is connected to the connector on the system board.
6. Close the blue latch to lock the M.2 Interposer board to the system.

NOTE: The numbers on the image do not depict the exact steps. The numbers are for representation of sequence.

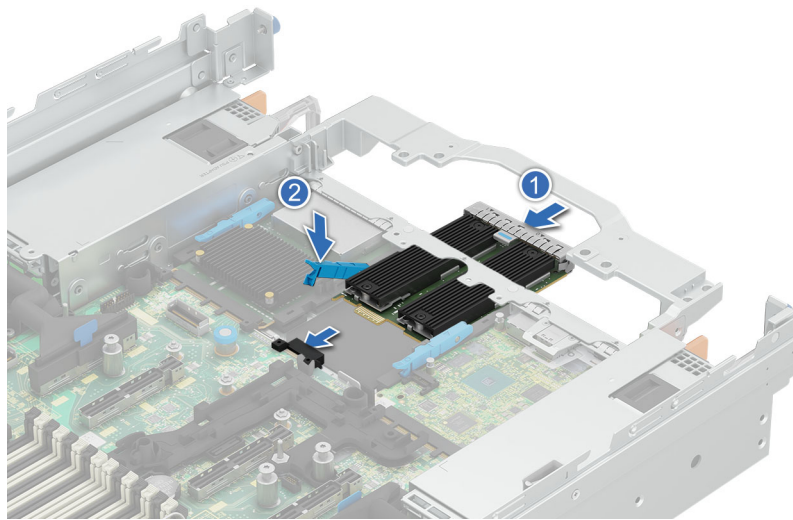

Figure 217. Installing the M.2 Interposer board

Next steps

1. [Install the rear expansion card riser](#) or [install the rear expansion card riser blanks](#).
2. Follow the procedure listed in the [After working inside your system](#).

Optional BOSS-N1 DC-MHS module

This is a service technician replaceable part only.

Removing the BOSS-N1 DC-MHS card carrier blank

Prerequisites

1. Follow the safety guidelines listed in the [Safety instructions](#).

Steps

Press and pull the BOSS-N1 DC-MHS card carrier blank out from the BOSS-N1 DC-MHS controller.



Figure 218. Removing the BOSS-N1 DC-MHS card carrier blank

Next steps

1. [Replace the BOSS-N1 DC-MHS card carrier blank](#) or [install BOSS-N1 DC-MHS card carrier](#).

Installing the BOSS-N1 DC-MHS card carrier blank

Prerequisites

1. Follow the safety guidelines listed in the [Safety instructions](#).

Steps

Align the blank with the BOSS-N1 DC-MHS controller bay and push it into the bay until it clicks into place.



Figure 219. Installing the BOSS-N1 DC-MHS card carrier blank

Removing the front BOSS-N1 DC-MHS module

Prerequisites

1. Follow the safety guidelines listed in the [Safety instructions](#).
2. Follow the procedure listed in the [Before working inside your system](#).
3. If required, [remove the air shroud](#).
4. If required, [remove the cooling fan cage assembly](#).
5. [Remove the drive backplane cover](#).
6. If required, [remove the M.2 NVMe SSD module](#).
7. [Remove the front expansion card riser](#).

NOTE: Front riser 1 must be removed, before removing riser 2 to access the front BOSS-N1 DC-MHS module.

8. Disconnect the cables from the system board, observe the cable routing.

NOTE: See [cable routing](#) section for more information.

Steps

1. Lift the plunger and slide the BOSS-N1 DC-MHS controller tray out of the riser 2.

NOTE: The numbers on the image do not depict the exact steps. The numbers are for representation of sequence.

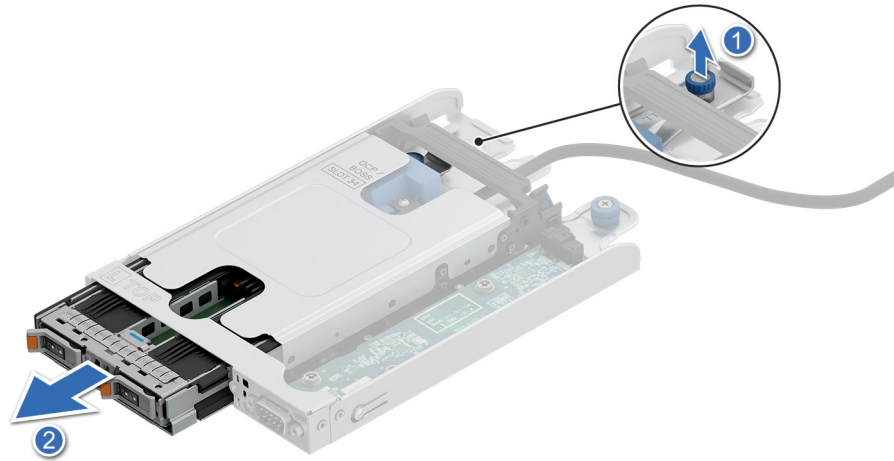

Figure 220. Removing a BOSS-N1 DC-MHS controller tray from the riser

2. Press both ends of the cable holder and tilt the BOSS-N1 DC-MHS controller cable holder.
3. Pull the BOSS-N1 DC-MHS controller cable out of the riser.

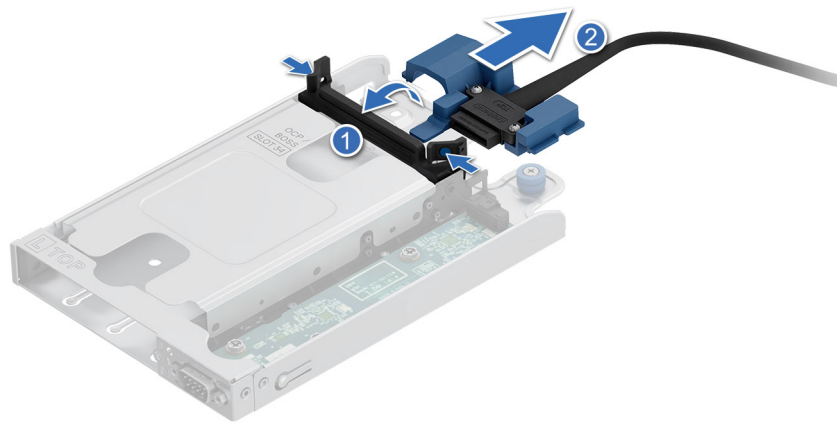

Figure 221. Removing a BOSS-N1 DC-MHS cable

4. Push the clips outward and slide out the BOSS-N1 DC-MHS controller from the tray.

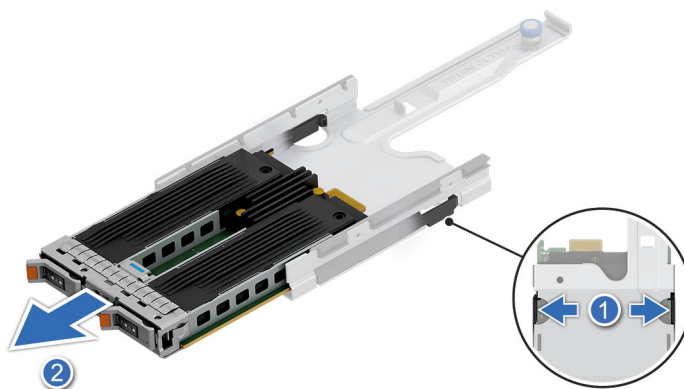

Figure 222. Removing a BOSS-N1 DC-MHS controller from tray

5. If you do not plan to replace the BOSS-N1 DC-MHS controller card, install a filler bracket.

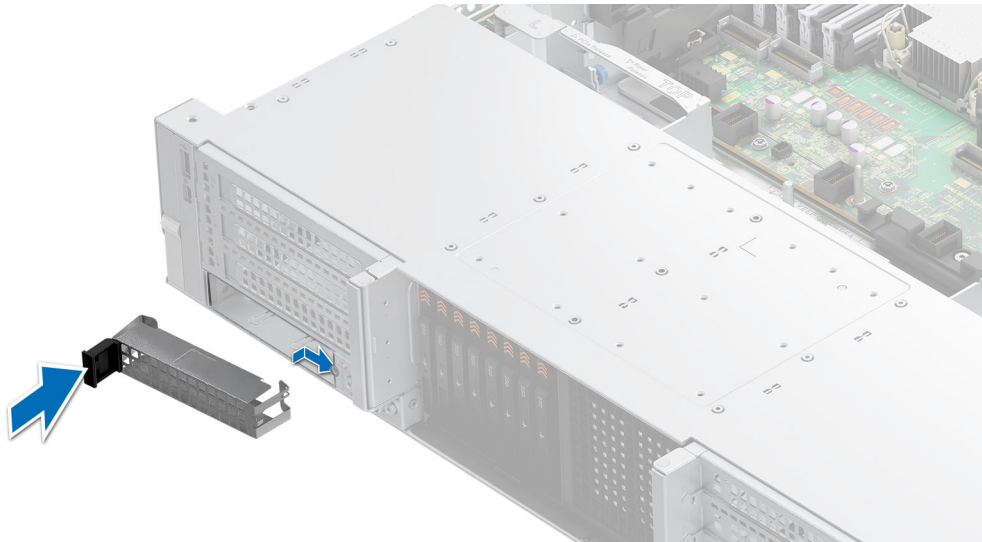

Figure 223. Installing a BOSS-N1 DC-MHS controller filler bracket

Next steps

Replace the front BOSS-N1 DC-MHS module .

Installing the front BOSS-N1 DC-MHS module

Prerequisites

1. Follow the safety guidelines listed in the [Safety instructions](#).
2. Follow the procedure listed in the [Before working inside your system](#).
3. If required, [remove the air shroud](#).
4. If required, [remove the cooling fan cage assembly](#).
5. [Remove the drive backplane cover](#).
6. If required, [remove the M.2 NVMe SSD module](#).
7. [Remove the front expansion card riser](#).

i **NOTE:** Front riser 1 must be removed, before removing riser 2 to access the front BOSS-N1 DC-MHS module.

8. Route and connect the cables from the system board, observe the cable routing.

i **NOTE:** See [cable routing](#) section for more information.

i **NOTE:** Install front riser 2 before installing riser 1.

⚠ CAUTION: Do not install GPUs, network cards, or other PCIe devices on your system that are not validated and tested by Dell. Damage caused by unauthorized and invalidated hardware installation will null and void the system warranty.

Steps

1. If installed, remove the filler bracket.

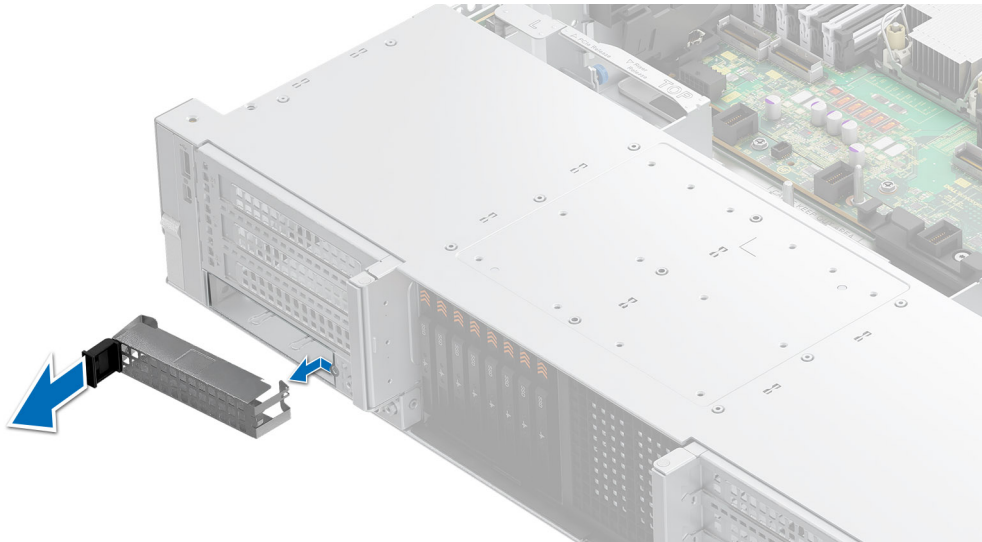

Figure 224. Removing an BOSS-N1 DC-MHS controller filler bracket

2. Align and slide the BOSS-N1 DC-MHS controller into the tray until seated.

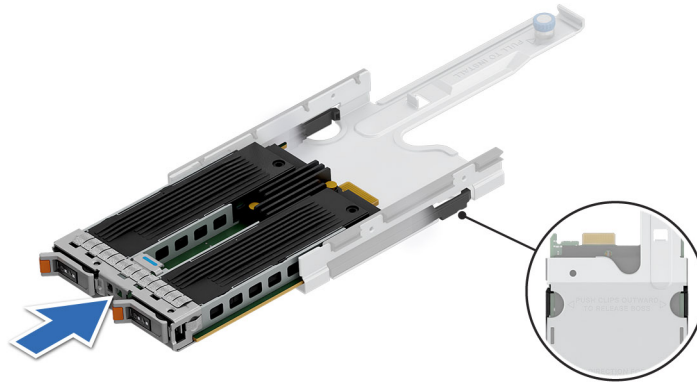

Figure 225. Installing an BOSS-N1 DC-MHS controller into tray

3. Place the BOSS-N1 DC-MHS controller cable to unlock position line on the riser and slide the cable to lock position line.
4. Tilt the cable holder to secure the BOSS-N1 DC-MHS controller cable into the riser.

i **NOTE:** Ensure that the BOSS-N1 DC-MHS controller is properly connected to the cable connector.

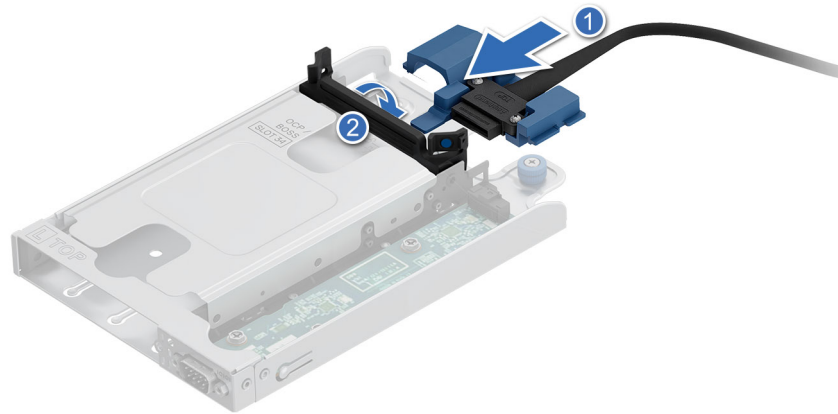

Figure 226. Installing an BOSS-N1 DC-MHS cable

5. Align and slide the BOSS-N1 DC-MHS controller tray into the riser until the plunger press the stop point.
6. Pull up the plunger and slide to secure the plunger into the hole on the riser.

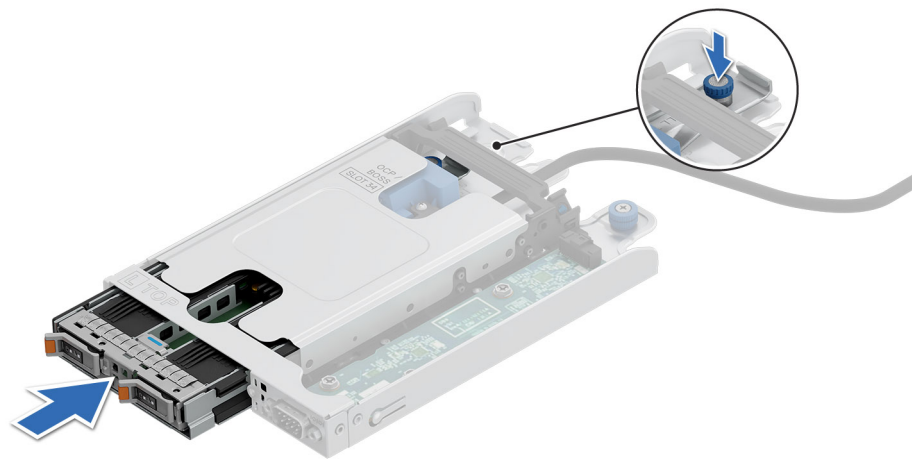

Figure 227. Installing the BOSS-N1 DC-MHS controller tray into riser

Next steps

1. Route and connect the cables, taking care not to damage them.

NOTE: See [cable routing](#) section for more information.

2. If removed, [install the M.2 NVMe SSD module](#)
3. [Install the front expansion card risers.](#)
4. [Install the cooling fan cage assembly.](#)
5. If removed, [install the air shroud.](#)
6. If removed, [install the drive backplane cover.](#)
7. Follow the procedure listed in the [After working inside your system.](#)

Removing the rear BOSS-N1 DC-MHS module

Prerequisites

1. Follow the safety guidelines listed in the [Safety instructions.](#)
2. Follow the procedure listed in [Before working inside your system.](#)

3. Remove the system cover
4. Remove the rear expansion card riser or Remove the rear expansion card riser blank
5. Remove the M.2 NVMe SSD module.

Steps

1. Open the blue latch to disengage the BOSS-N1 DC-MHS module.
2. Push the BOSS-N1 DC-MHS module towards the rear end of the system to disconnect from the connector on the HPM board.
3. Slide the BOSS-N1 DC-MHS module out of the slot on the system.

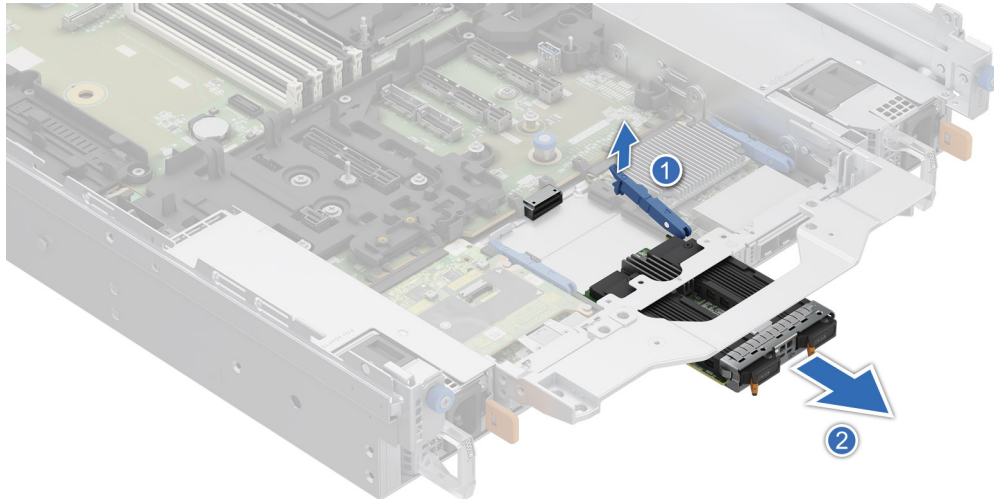

Figure 228. Removing the rear BOSS-N1 DC-MHS

4. If the BOSS-N1 DC-MHS module is not going to be replaced, install a filler bracket.

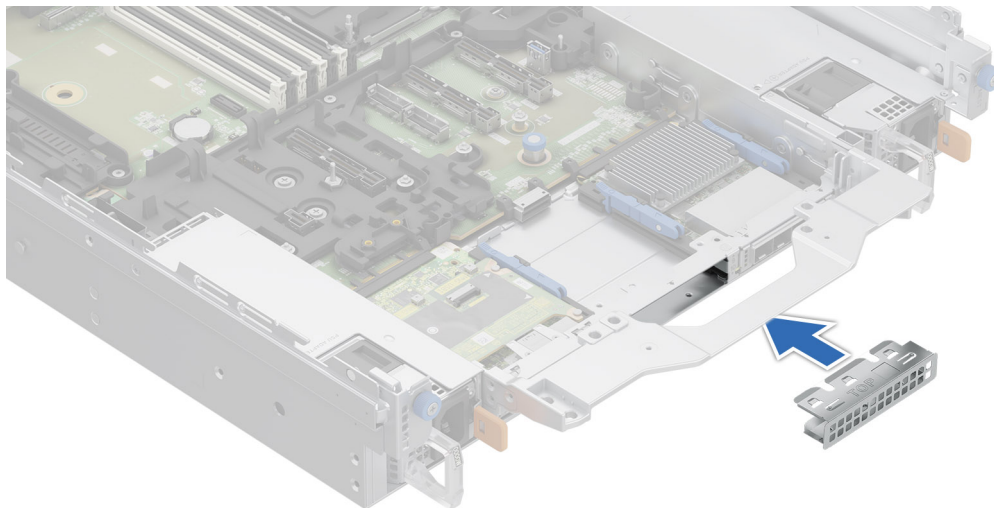

Figure 229. Installation of filler bracket

Next steps

1. Replace the rear BOSS-N1 DC-MHS module.

Installing the rear BOSS-N1 DC-MHS module

Prerequisites

1. Follow the safety guidelines listed in the [Safety instructions](#).
2. Follow the procedure listed in [Before working inside your system](#).
3. [Remove the system cover](#)
4. [Remove the rear expansion card riser](#) or [Remove the rear expansion card riser blank](#)
5. [Remove the M.2 NVMe SSD module](#).

Steps

1. If installed, remove the filler bracket.

NOTE: Store the filler bracket for future use. Filler brackets must be installed in empty expansion card slots to maintain Federal Communications Commission (FCC) certification of the system. The brackets also keep dust and dirt out of the system and aid in proper cooling and airflow inside the system.

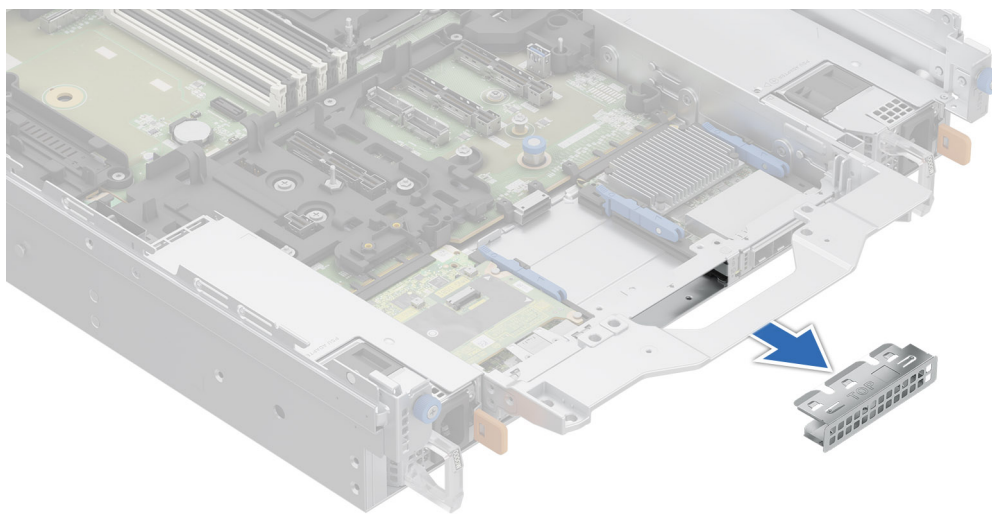

Figure 230. Removal of filler bracket

2. Open the blue latch on the HPM board.
3. Slide the BOSS-N1 DC-MHS module into the slot in the system.
4. Push until the BOSS-N1 DC-MHS module is connected to the connector on the HPM board.
5. Close the blue latch to lock the BOSS-N1 DC-MHS module to the system.

NOTE: The numbers on the image do not depict the exact steps. The numbers are for representation of sequence.

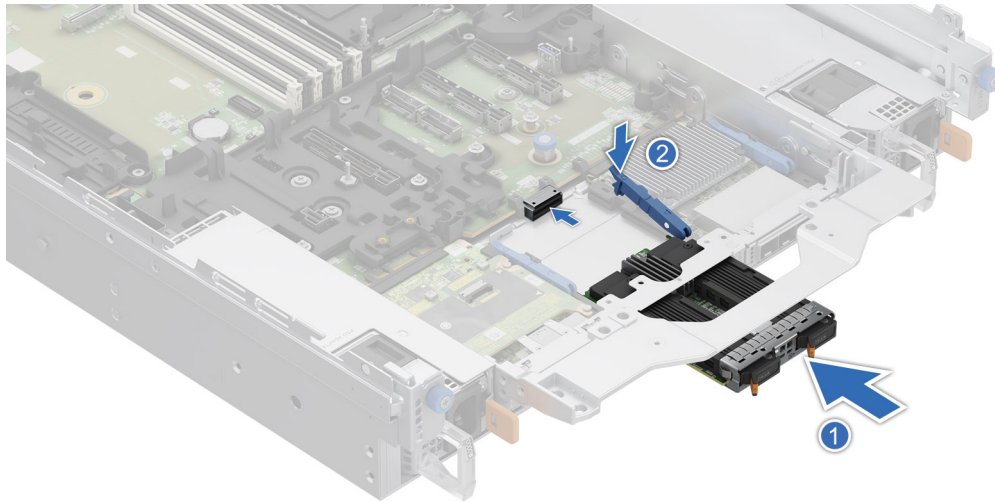

Figure 231. Installing the BOSS-N1 DC-MHS module

Next steps

1. Install the M.2 NVMe SSD module.
2. Install the rear expansion card riser or install the rear expansion card riser blanks
3. Follow the procedure listed in the [After working inside your system](#).

Optional OCP NIC card

Removing the front OCP NIC card

Prerequisites

1. Follow the safety guidelines listed in the [Safety instructions](#).
2. Follow the procedure listed in the [Before working inside your system](#).
3. If required, [remove the air shroud](#).
4. If required, [remove the cooling fan cage assembly](#).
5. [Remove the drive backplane cover](#).
6. [Remove the front expansion card riser](#).

NOTE: Front riser 3 must be removed, before removing riser 4 to access the front OCP NIC card.

7. Disconnect the cables from the system board, observe the cable routing.

NOTE: See [cable routing](#) section for more information.

Steps

1. Loosen the captive screw on the riser.

NOTE: The captive screw is available on the OCP tray or on the OCP NIC card itself, depending on the OCP NIC card used.

2. Slide the OCP NIC tray out of the riser.

NOTE: The numbers on the image do not depict the exact steps. The numbers are for representation of sequence.

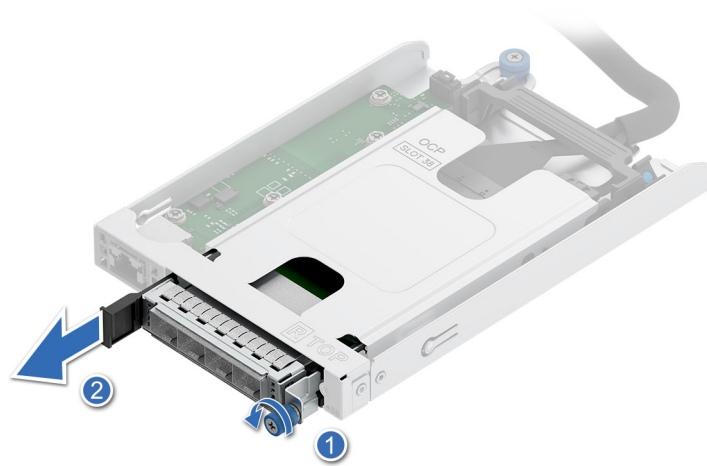

Figure 232. Removing an OCP NIC card tray from the riser

3. Press both ends of the cable holder and tilt the OCP NIC cable holder.
4. Pull the OCP NIC cable out of the riser.

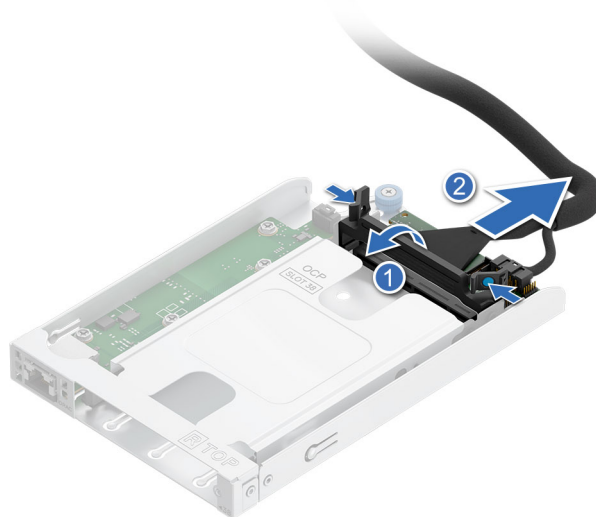

Figure 233. Removing an OCP NIC cable

5. Push the clips outward and slide out the OCP NIC card from the OCP tray.

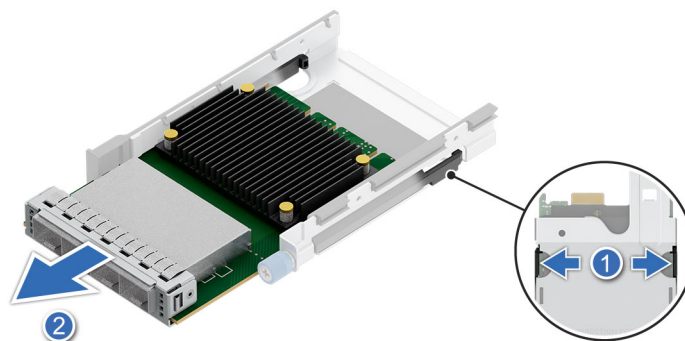

Figure 234. Removing an OCP NIC card from OCP tray

6. If the OCP NIC card is not going to be replaced, install a filler.

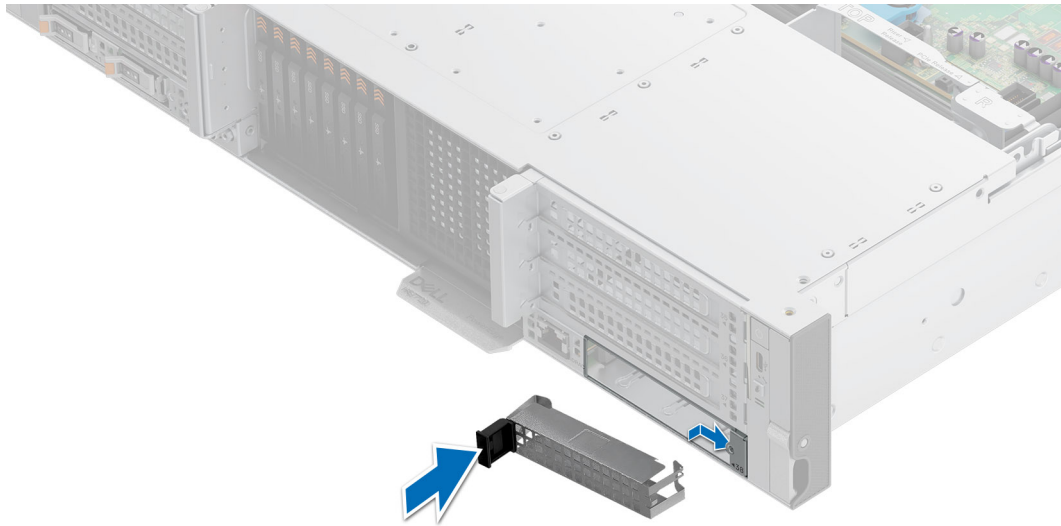

Figure 235. Installing an OCP NIC card filler bracket

Next steps

Replace the front OCP NIC card.

Installing the front OCP NIC card

Prerequisites

1. Follow the safety guidelines listed in the [Safety instructions](#).
2. Follow the procedure listed in [Before working inside your system](#).
3. If required, [remove the air shroud](#).
4. If required, [remove the cooling fan cage assembly](#).
5. [Remove the drive backplane cover](#).
6. [Remove the front expansion card riser](#).
7. **i** **NOTE:** Front riser 3 must be removed, before removing riser 4 to access the front OCP NIC card.
8. Disconnect the cables from the system board, observe the cable routing.

i **NOTE:** See [cable routing](#) section for more information.

△ CAUTION: Do not install GPUs, network cards, or other PCIe devices on your system that are not validated and tested by Dell. Damage caused by unauthorized and invalidated hardware installation will null and void the system warranty.

Steps

1. If installed, remove the filler bracket.

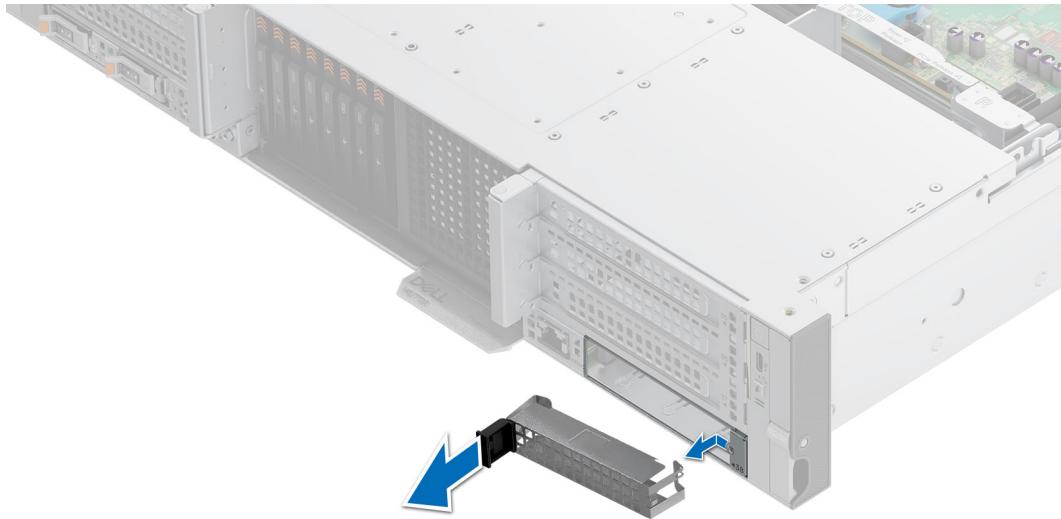

Figure 236. Removing an OCP NIC card filler bracket

2. Align and slide OCP NIC card into the OCP tray until seated.

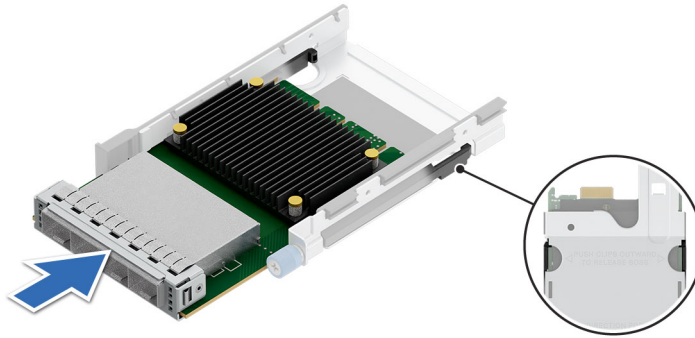

Figure 237. Installing an OCP NIC card into OCP tray

3. Place the OCP NIC card cable to unlock position line on the riser and slide the cable to lock position line.
4. Tilt the cable holder to secure the OCP NIC card cable into the riser.

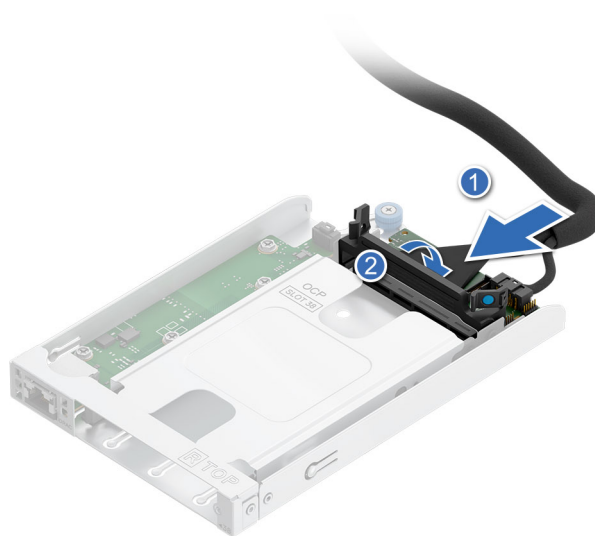

Figure 238. Installing an OCP NIC cable

5. Align and slide the OCP NIC card tray into the riser.

NOTE: Ensure that the OCP NIC card is properly connected to the cable connector.

6. Tighten the captive screw to secure the OCP NIC card tray into the riser.

NOTE: The captive screw is available on the OCP tray or in the OCP NIC card itself, depending on the OCP NIC card used.

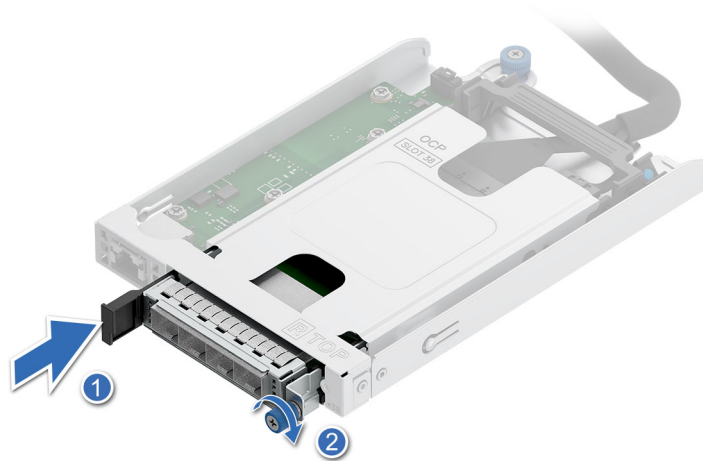

Figure 239. Installing the OCP NIC tray into riser

Next steps

1. Route and connect the cables, taking care not to damage them.

NOTE: See [cable routing](#) section for more information.

2. [Install the front expansion card risers.](#)
3. [Install the cooling fan cage assembly.](#)
4. If removed, [install the air shroud.](#)
5. If removed, [install the drive backplane cover.](#)
6. Follow the procedure listed in the [After working inside your system.](#)

Removing the rear OCP NIC card

Prerequisites

1. Follow the safety guidelines listed in the [Safety instructions.](#)
2. Follow the procedure listed in the [Before working inside your system.](#)
3. If required, [remove the air shroud.](#)
4. [Remove the rear expansion card riser](#) or [remove the rear expansion card riser blanks](#)
5. If the OCP NIC card of PCIe width x16 is used, disconnect an additional OCP NIC cable from the system board.

NOTE: See [cable routing](#) section.

Steps

1. Open the blue latch to disengage the OCP NIC card.
2. Push the OCP NIC card towards the rear end of the system to disconnect from the connector on the system board.
3. Slide the OCP NIC card out of the slot on the system.

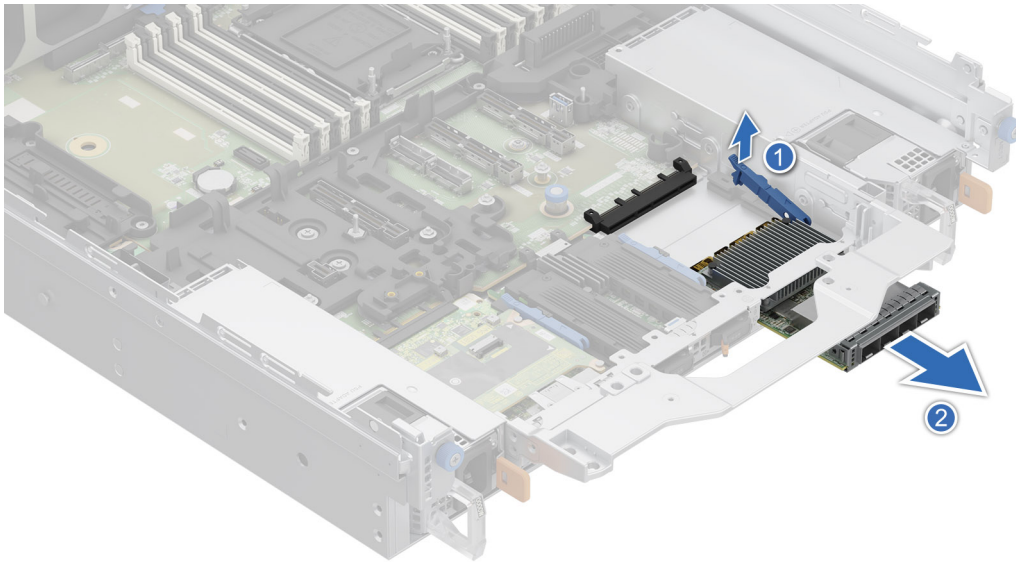

Figure 240. Removing the rear OCP NIC card

4. If the OCP NIC card is not going to be replaced, install a filler bracket .

i **NOTE:** You must install a filler bracket over an empty expansion card slot to maintain Federal Communications Commission (FCC) certification of the system. The brackets also keep dust and dirt out of the system and aid in proper cooling and airflow inside the system.

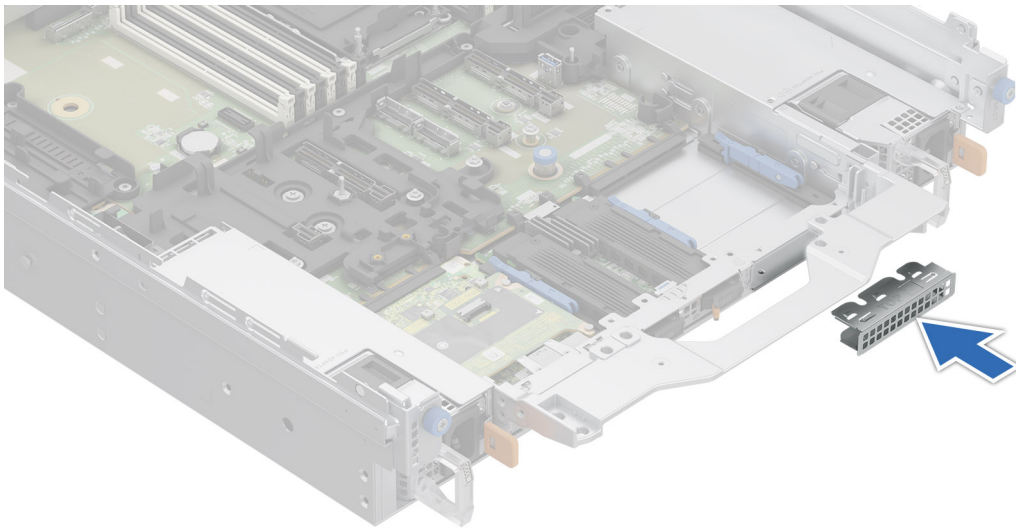

Figure 241. Installation of filler bracket

Next steps

1. [Replace the rear OCP NIC card.](#)

Installing the rear OCP NIC card

Prerequisites

1. Follow the safety guidelines listed in the [Safety instructions](#).
2. Follow the procedure listed in the [Before working inside your system](#).
3. If required, [remove the air shroud](#).

4. Remove the rear expansion card riser or remove the rear expansion card riser blanks
5. If the OCP NIC card of PCIe width x16 is used, disconnect an additional OCP NIC cable from the system board.

i **NOTE:** See [cable routing](#) section.

△ **CAUTION:** Do not install GPUs, network cards, or other PCIe devices on your system that are not validated and tested by Dell. Damage caused by unauthorized and invalidated hardware installation will null and void the system warranty.

Steps

1. If installed, remove the filler bracket.

i **NOTE:** Store the filler bracket for future use. Filler brackets must be installed in empty expansion card slots to maintain Federal Communications Commission (FCC) certification of the system. The brackets also keep dust and dirt out of the system and aid in proper cooling and airflow inside the system.

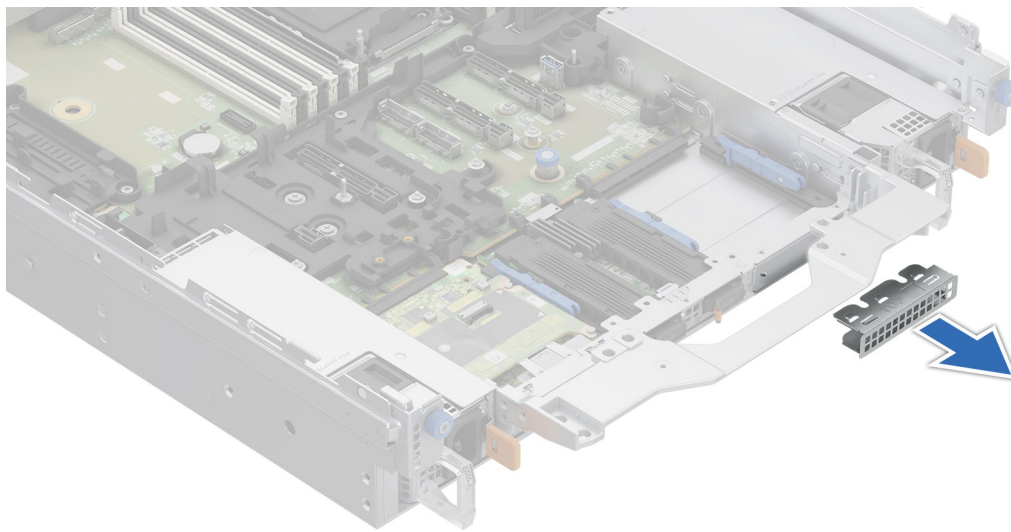

Figure 242. Removal of filler bracket

2. Open the blue latch on the system board.
3. Slide the OCP NIC card into the slot in the system.
4. Push until the OCP NIC card is connected to the connector on the system board.
5. Close the blue latch to lock the OCP NIC card to the system.

i **NOTE:** The numbers on the image do not depict the exact steps. The numbers are for representation of sequence.

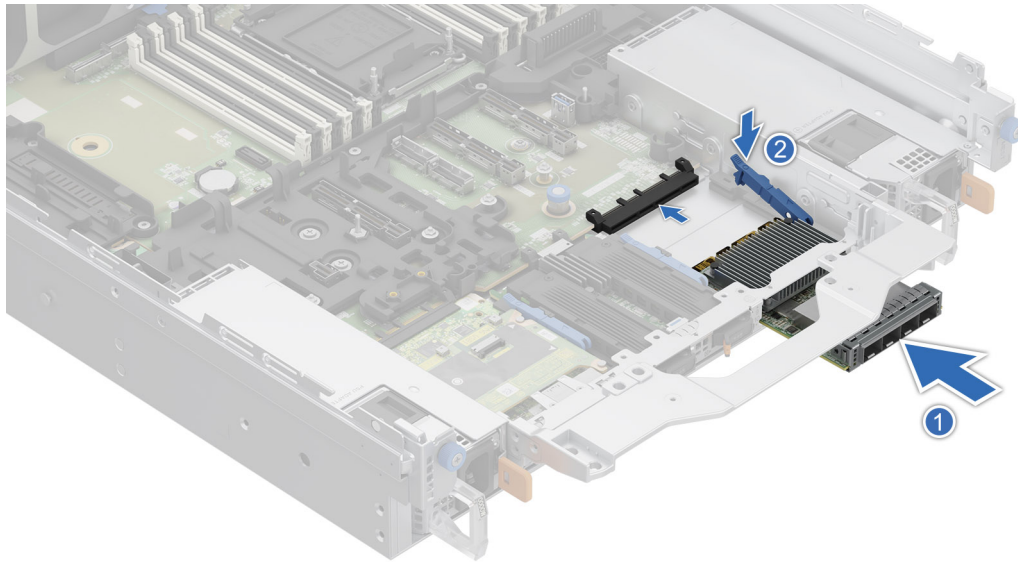

Figure 243. Installing the rear OCP NIC card

Next steps

1. If the OCP NIC card of PCIe width x16 is used, connect an additional OCP NIC cable on the system board.

NOTE: See [cable routing](#) section.

2. [Install the rear expansion card riser](#) or [install the rear expansion card riser blanks](#)
3. If removed, [install the air shroud](#).
4. Follow the procedure listed in [After working inside your system](#).

Datacenter-Secure Control Module (DC-SCM)

This is a service technician replaceable part only.

Removing the DC-SCM board

Prerequisites

1. Follow the safety guidelines listed in the [Safety instructions](#).
2. Follow the procedure listed in the [Before working inside your system](#).
3. If required, [remove the air shroud](#).
4. [Remove the rear expansion card riser](#) or [remove the rear expansion card riser blanks](#)

Steps

1. Open the blue latch to disengage the DC-SCM board.
2. Push the DC-SCM board towards the rear end of the system to disconnect from the connector on the HPM board.
3. Slide the DC-SCM board out of the slot on the system.

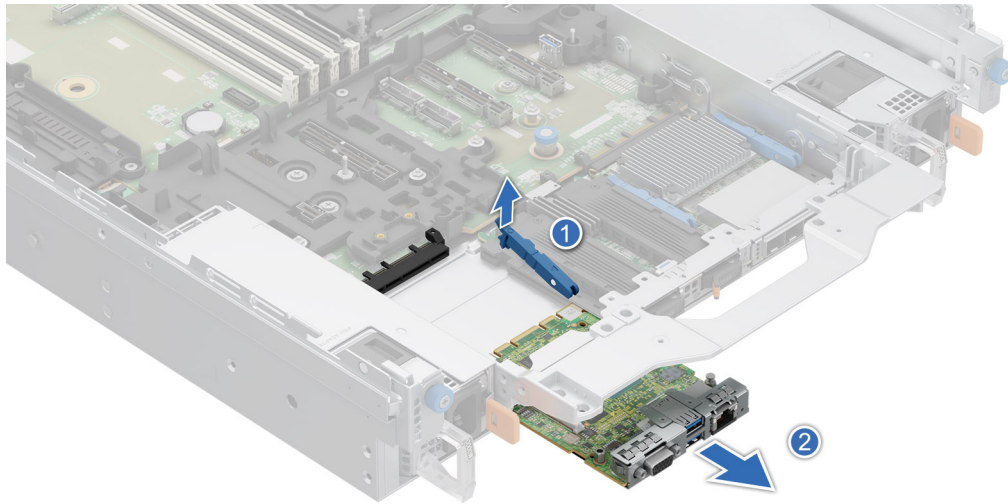

Figure 244. Removing the DC-SCM board

Next steps

- i** **NOTE:** If a new DC-SCM board is being installed, the Attic board must be removed from the existing DC-SCM board and installed on the new board.
 - i** **NOTE:** If the optional KVM module is installed, kindly make note of the cable routing, see the [cable routing](#) section.
1. [Replace the DC-SCM board.](#)

Installing the DC-SCM board

Prerequisites

1. Follow the safety guidelines listed in the [Safety instructions](#).
2. Follow the procedure listed in the [Before working inside your system](#).
3. If required, [remove the air shroud](#).
4. [Remove the rear expansion card riser](#) or [remove the rear expansion card riser blanks](#)

⚠ CAUTION: Do not install GPUs, network cards, or other PCIe devices on your system that are not validated and tested by Dell. Damage caused by unauthorized and invalidated hardware installation will null and void the system warranty.

- i** **NOTE:** If a new DC-SCM board is being installed, the Attic board must be removed from the existing DC-SCM board and installed on the new board.
- i** **NOTE:** If the optional KVM module is installed, kindly make note of the cable routing, see the [cable routing](#) section.

Steps

1. Open the blue latch on the HPM board.
2. Slide the DC-SCM board into the slot in the system.
3. Push until the DC-SCM board is connected to the connector on the HPM board.
4. Close the blue latch to lock the DC-SCM board to the system.

i **NOTE:** The numbers on the image do not depict the exact steps. The numbers are for representation of sequence.

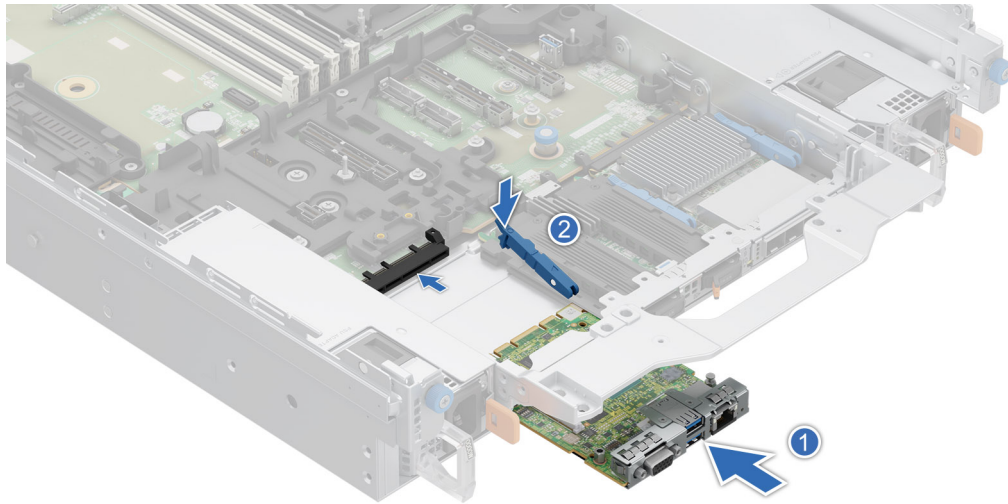

Figure 245. Installing the DC-SCM board

Next steps

1. [Install the rear expansion card riser](#) or [install the rear expansion card riser blanks](#).
2. If removed, [install the air shroud](#).
3. Power on the system.
4. Ensure that you perform the following steps:
 - a. Use the Easy Restore feature to restore the BIOS and Service Tag. See the [Restoring the system using the Easy Restore feature](#) section.
 - b. If the service tag is not backed up in the backup flash device, enter the system service tag manually. See the [Manually update the Service Tag](#) by using System Setup section.
 - c. Install BIOS and iDRAC version updates, Diagnostics, and OS Driver Pack and OS Collector.
 - d. Re-enable the Trusted Platform Module (TPM). See the [Initializing TPM](#) section.
5. Follow the procedure listed in [After working inside your system](#).

Restoring the system using Easy Restore

The Easy Restore feature restores the server service tag and BIOS configuration data after replacing the Datacenter-Secure Control Module (DC-SCM). System configuration data is automatically maintained in a backup flash device within the system. If the BIOS detects a new DC-SCM during server boot, the system prompts the user to restore the backup system configuration data.

About this task

For more information about the Easy Restore feature, see Open BMC configuration Users Guide at [Support for Open Server Manager | Documentation | Dell India](#).

When the DC-SCM is booted for the first time, it presents a screen with settings it can restore, below is a list of options/steps available:

Steps

1. To restore the system configuration data, press **Y**
2. To skip restore for this boot, press **N**
3. Enter BIOS setup to manually restore Service Tag, press **F2**



Figure 246. Easy Restore

Manually update the Service Tag

After replacing a HPM board, if Easy Restore fails, follow this process to manually enter the Service Tag, using **System Setup**.

About this task

If you know the system service tag, use the **System Setup** menu to enter the service tag.

Steps

1. Power on the system.
2. To enter the **System Setup**, press **F2**.
3. Click **Service Tag Settings**.
4. Enter the service tag.

NOTE: You can enter the service tag only when the **Service Tag** field is empty. Ensure that you enter the correct service tag. Once the service tag is entered, it cannot be updated or changed. Incorrectly entered service tag will lead to HPM board replacement.

5. Click **OK**.

Attic board

This is a service technician replaceable part only.

Removing the Attic board

Prerequisites

1. Follow the safety guidelines listed in the [Safety instructions](#).
2. Follow the procedure listed in the [Before working inside your system](#).
3. If required, [remove the air shroud](#).
4. [Remove the rear expansion card riser](#) or [remove the rear expansion card riser blanks](#)
5. [Remove the DC-SCM board](#).

NOTE: Disconnect the Attic cable. See the [cable routing](#) section.

Steps

1. Using the Phillips 1 screwdriver, loosen the captive screws securing the attic board to the DC-SCM board.
2. Tilt and lift the Attic board from the DC-SCM guide pins.

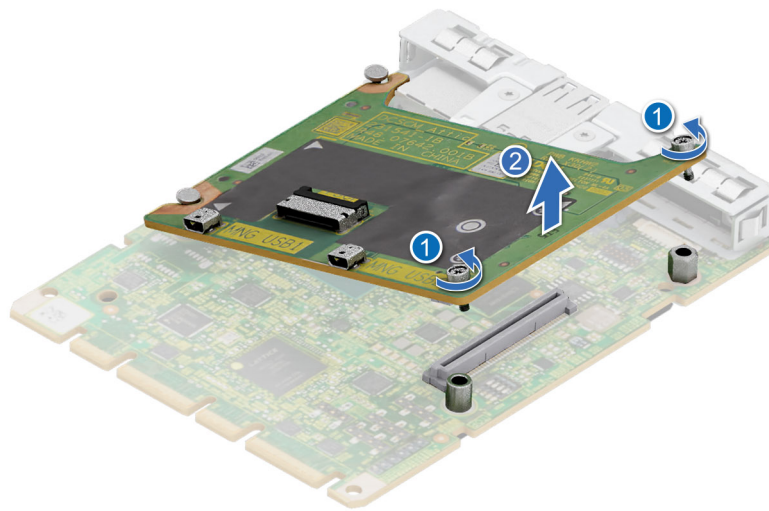

Figure 247. Removing the Attic board

Next steps

1. [Replace the Attic board](#).

Installing the Attic board

Prerequisites

1. Follow the safety guidelines listed in the [Safety instructions](#).
2. Follow the procedure listed in the [Before working inside your system](#).
3. If required, [remove the air shroud](#).
4. [Remove the rear expansion card riser](#) or [remove the rear expansion card riser blanks](#)
5. [Remove the DC-SCM board](#).

NOTE: Disconnect the Attic cable. See the [cable routing](#) section.

CAUTION: Do not install GPUs, network cards, or other PCIe devices on your system that are not validated and tested by Dell. Damage caused by unauthorized and invalidated hardware installation will null and void the system warranty.

Steps

1. Align the Attic board at an angle with the guide pins on the DC-SCM board.
2. Press until the Attic board is connected to the connector on the DC-SCM board.
3. Using a Phillips 1 screwdriver, tighten the captive screws.

NOTE: The numbers on the image do not depict the exact steps. The numbers are for representation of sequence.

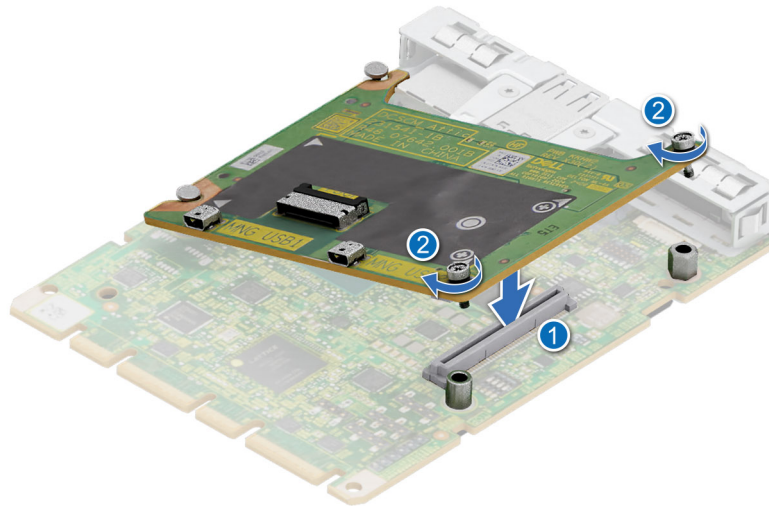

Figure 248. Installing the Attic board

Next steps

1. Install the DC-SCM board.

NOTE: Connect the Attic cable, see [cable routing](#) section.

2. Install the rear expansion card riser or install the rear expansion card riser blanks.
3. If removed, install the air shroud.
4. Follow the procedure listed in [After working inside your system](#).

Internal USB

Removing the internal USB

Prerequisites

CAUTION: To avoid interference with other components in the server, the maximum permissible dimensions of the USB memory key are 15.9 mm wide x 57.15 mm long x 7.9 mm high.

1. Follow the safety guidelines listed in the [Safety instructions](#).
2. Follow the procedure listed in the [Before working inside your system](#).
3. If required, [remove the air shroud](#).
4. [Remove the rear expansion card riser](#) or [remove the rear expansion card riser blanks](#)

Steps

1. Locate the USB card on the HPM board.
To locate the USB port on the HPM board, see [HPM board jumpers and connectors](#).
2. Lift the internal USB card to disconnect from the connector on the HPM board.

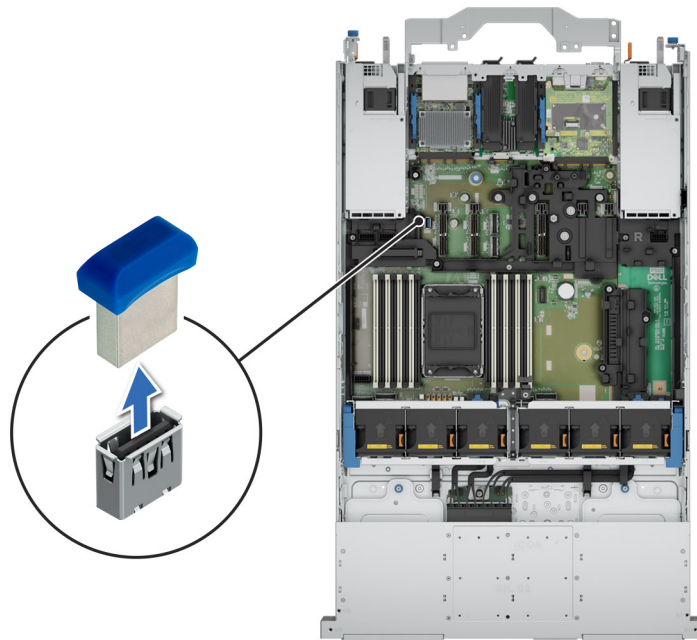

Figure 249. Removing the internal USB card

Next steps

1. [Replace the internal USB card.](#)

Installing the Internal USB

Prerequisites

1. Follow the safety guidelines listed in the [Safety instructions](#).
2. Follow the procedure listed in the [Before working inside your system](#).
3. If required, [remove the air shroud](#).
4. [Remove the rear expansion card riser](#) or [remove the rear expansion card riser blanks](#)

Steps

Align the internal USB card with the USB port on the HPM board and press firmly until it is properly seated.

NOTE: For information about the exact location of USB on HPM board, see [HPM board jumpers and connectors](#) section.

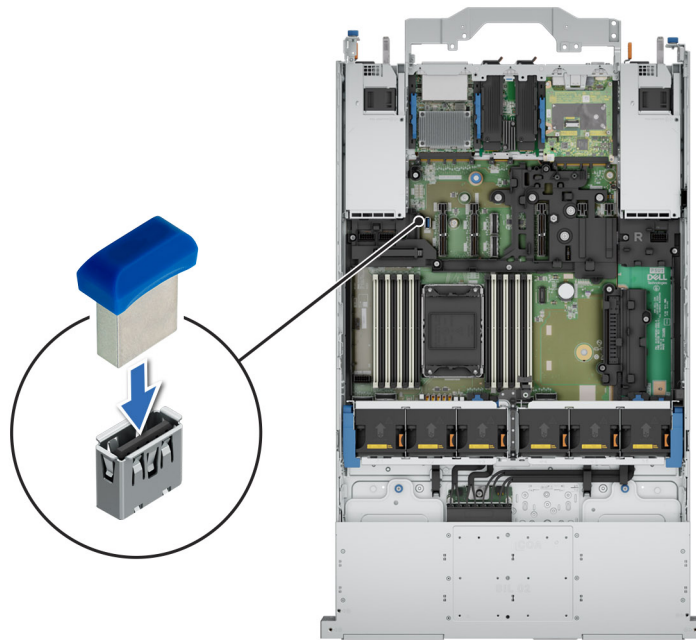

Figure 250. Installing the internal USB card

Next steps

1. Install the rear expansion card riser or install the rear expansion card riser blanks.
2. If removed, install the air shroud.
3. Follow the procedure listed in [After working inside your system](#).
4. While booting, press F2 to enter **System Setup** and verify that the system detects the USB memory key.

System battery

This is a service technician replaceable part only.

Replacing the system battery

Prerequisites

⚠ WARNING: There is a danger of a new battery exploding if it is incorrectly installed. Replace the battery only with the same or equivalent type that is recommended by the manufacturer. Discard used batteries according to the manufacturer's instructions. See the Safety instructions that came with your system for more information.

1. Follow the safety guidelines listed in the [Safety instructions](#).
2. Follow the procedure listed in the [Before working inside your system](#).
3. [Remove the system cover](#).
4. [Remove the air shroud](#).

Steps

1. Press and hold the battery socket retention latch, for the battery to pop out.

i NOTE: If the battery does not pop out, then lift it out of the socket.

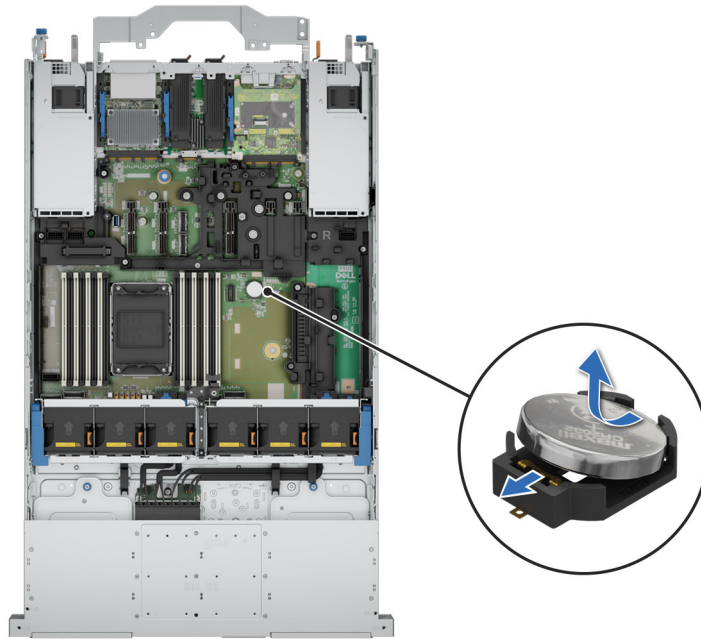

Figure 251. Removing the system battery

2. To install a new system battery, hold the battery with the positive side facing up at an angle and slide it under the battery holder socket latch.
3. Press the battery into the connector until it snaps into place.

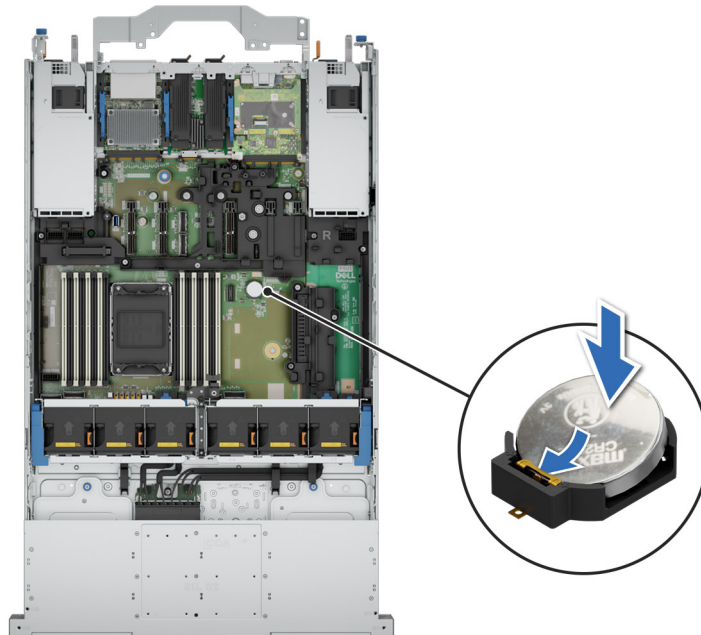

Figure 252. Installing the system battery

Next steps

1. [Install the air shroud.](#)
2. [Install the system cover.](#)
3. Follow the procedure listed in [After working inside your system.](#)
4. Confirm that the battery is operating properly, by performing the following steps:
 - a. Enter the System Setup, while booting, by pressing F2.

- b. Enter the correct time and date in the System Setup **Time** and **Date** fields.
- c. **Exit** the System Setup.
- d. To test the newly installed battery, check the time and date at least an hour after installing the battery.
- e. Enter the System Setup and if the time and date are still incorrect, see [Getting help](#) section.

Intrusion switch

This is a service technician replaceable part only.

Removing the intrusion switch module

Prerequisites

1. Follow the safety guidelines listed in the [Safety instructions](#).
2. Follow the procedure listed in the [Before working inside your system](#).
3. [Remove the system cover](#).
4. [Remove the rear expansion card riser](#) or [remove the rear expansion card riser blanks](#)

i **NOTE:** Ensure that you note the routing of the cable as you remove it from the HPM board. Route the cable properly when you replace it to prevent the cable from being pinched or crimped.

Steps

1. Using a Phillips 1 screwdriver, loosen the screws on the intrusion switch module.
2. Disconnect the intrusion switch cable and the dongle cable.

i **NOTE:** The intrusion switch cable is connected to the dongle cable, which in turn is connected to the HPM board. See the [cable routing](#) section.

3. Disconnect the dongle cable in the J slot connector on the HPM board.

i **NOTE:** Detach the cable from the intrusion switch and keep it safe to be used when replacing with the new intrusion switch.

4. Lift the intrusion switch module along with dongle cable out of the system.

i **NOTE:** The numbers on the image do not depict the exact steps. The numbers are for representation of sequence.

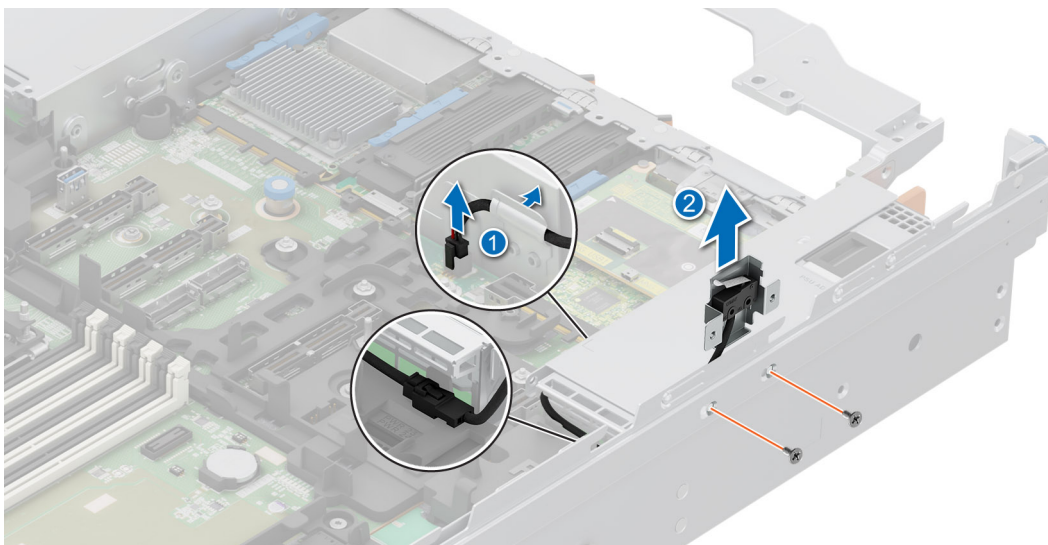

Figure 253. Removing the intrusion switch module

Next steps

1. [Replace the intrusion switch module.](#)

Installing the intrusion switch module

Prerequisites

1. Follow the safety guidelines listed in the [Safety instructions](#).
2. Follow the procedure listed in [Before working inside your system](#).
3. [Remove the system cover](#).
4. [Remove the rear expansion card riser](#) or [remove the rear expansion card riser blanks](#)

i **NOTE:** Ensure that you note the routing of the cable as you remove it from the HPM board. Route the cable properly when you replace it to prevent the cable from being pinched or crimped.

Steps

1. Align and place the intrusion switch module into the system.
2. Using a Phillips 1 screwdriver, tighten the screws to secure the intrusion switch module to the system chassis.
3. Connect the dongle cable and the intrusion switch cable.
4. Reconnect the dongle cable in the J slot connector on the HPM board.

i **NOTE:** The intrusion switch cable is connected to the dongle cable, which in turn is connected to the HPM board. See [cable routing](#) section.

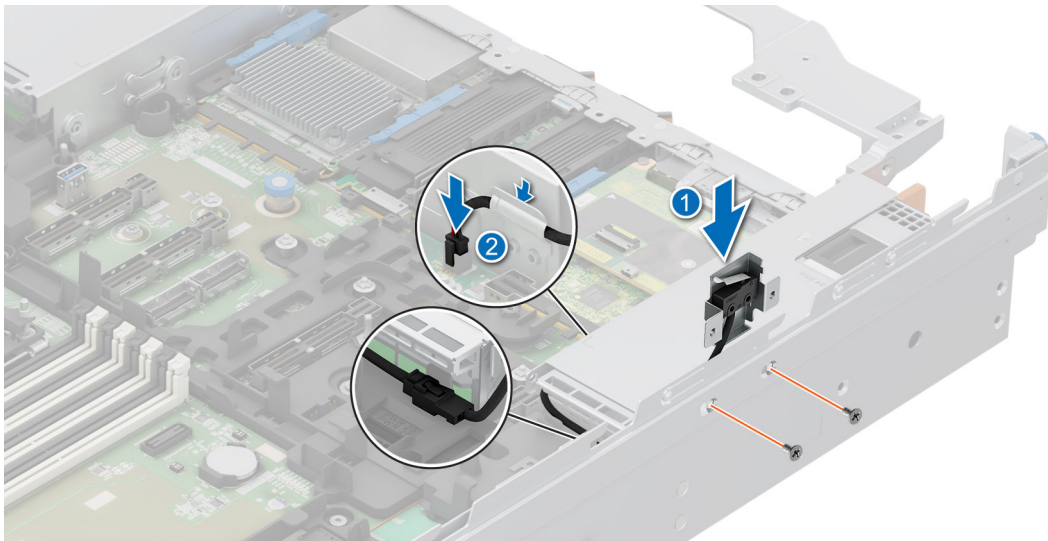

Figure 254. Installing the intrusion switch module

Next steps

1. [Install the rear expansion card riser](#) or [install the rear expansion card riser blanks](#).
2. [Install the system cover](#),
3. Follow the procedure listed in [After working inside your system](#).

Power supply unit

Removing a power supply unit

Prerequisites

CAUTION: The system requires one power supply unit (PSU) for normal operation. On power-redundant systems, remove and replace only one PSU at a time in a system that is powered on.

1. Follow the safety guidelines listed in the [Safety instructions](#).
2. Disconnect the power cable from the power outlet and from the PSU that you intend to remove.
3. Remove the cable from the strap on the PSU handle.
4. Unlatch and lift or remove the optional cable management accessory if it interferes with the PSU removal.

NOTE: For information about the cable management when the PSU is removed or installed while the system is in a rack, see the system's cable management arm documentation at [PowerEdge Manuals](#).

Steps

Press the release latch and holding the PSU handle, slide the PSU out of the bay.



Figure 255. Removing a power supply unit

Next steps

1. [Replace the PSU](#) or [install the PSU blank](#).

Installing a power supply unit

Prerequisites

1. Follow the safety guidelines listed in the [Safety instructions](#).
2. For systems that support redundant PSU, ensure that both the PSUs are of the same type and have the same maximum output power.

NOTE: The maximum output power (shown in watts) is listed on the PSU label.

3. If required, [Remove the PSU blank](#).

Steps

Slide the PSU into the PSU bay until the release latch snaps into place.



Figure 256. Installing a power supply unit

Next steps

1. If you have unlatched or removed the cable management accessory, reinstall or relatch it. For information about the cable management when the PSU is removed or installed while the system is in the rack, see the system's cable management accessory documentation at [PowerEdge Manuals](#).
2. Connect the power cable to the PSU, and plug the cable into a power outlet.

CAUTION: When connecting the power cable to the PSU, secure the cable to the PSU with the strap.

NOTE: When installing hot swapping, or hot adding a new PSU, wait for 15 seconds for the system to recognize the PSU and determine its status. The PSU redundancy may not occur until discovery is complete. The PSU status indicator turns green to indicate that the PSU is functioning properly.

Removing a power supply unit blank

Prerequisites

1. Follow the safety guidelines listed in the [Safety instructions](#).

Steps

Pull the blank out of the system.

CAUTION: For proper system cooling, the PSU blank must be installed in the second PSU bay in a non-redundant configuration. Remove the PSU blank only if you are installing a second PSU.

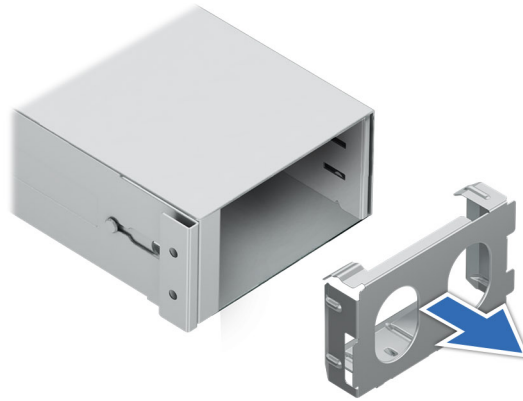

Figure 257. Removing a power supply unit blank

Next steps

1. Replace the PSU blank, or install the PSU.

Installing a power supply unit blank

Prerequisites

1. Follow the safety guidelines listed in the [Safety instructions](#).

NOTE: Install the power supply unit (PSU) blank only in the second PSU bay.

2. If required, [Remove the PSU](#), or [Remove the power supply blank](#).

Steps

Align the PSU blank with the PSU bay and push it into the PSU bay until it clicks into place.

NOTE: Make sure that the "Top" mark on the PSU blank is on the upper side.

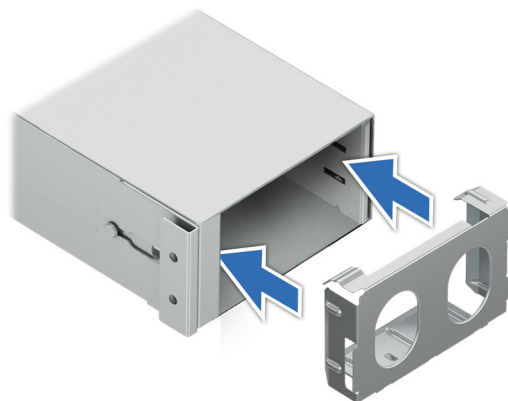

Figure 258. Installing a power supply unit blank

Installing a power supply unit filler

Prerequisites

1. Follow the safety guidelines listed in the [Safety instructions](#).

2. Follow the procedure listed in [Before working inside your system](#).
3. [Remove the PSU](#), or [Remove the power supply blank](#).

Steps

1. Align the guides on the filler with the slots on the PSU cage and slide until the filler is secured in the PSU cage.
2. Using a Philips 1 screwdriver, tighten the screw.

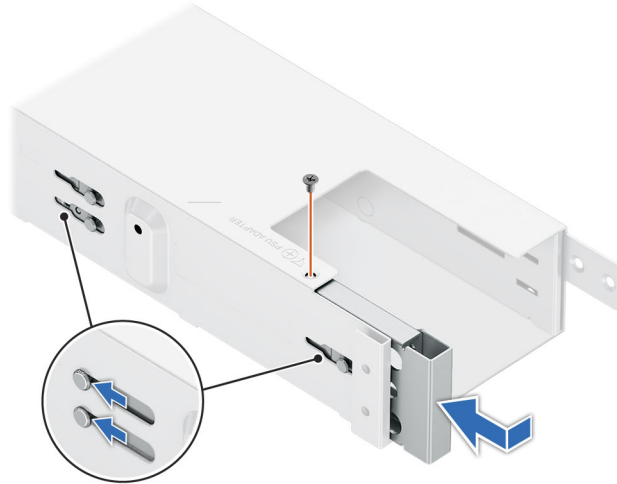

Figure 259. Installing the left PSU filler

3. Align the guides on the filler with the slots on the PSU cage and slide the filler, until the latch is locked with the PSU cage.

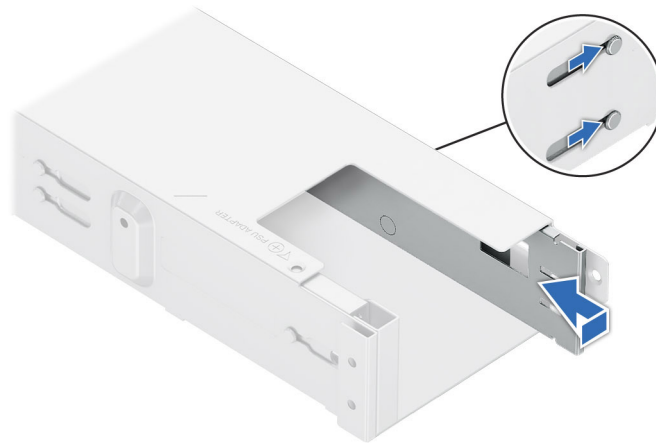

Figure 260. Installing the right PSU filler

Next steps

1. [Install the PSU](#) or [install the PSU blank](#).
2. Follow the procedure listed in [After working inside your system](#).

Installing a power supply unit filler

Prerequisites

1. Follow the safety guidelines listed in the [Safety instructions](#).
2. Follow the procedure listed in [Before working inside your system](#).
3. [Remove the PSU](#), or [Remove the power supply blank](#).

Steps

1. Align the guides on the filler with the slots on the PSU cage and slide until the filler is secured in the PSU cage.
2. Using a Philips 1 screwdriver, tighten the screw.

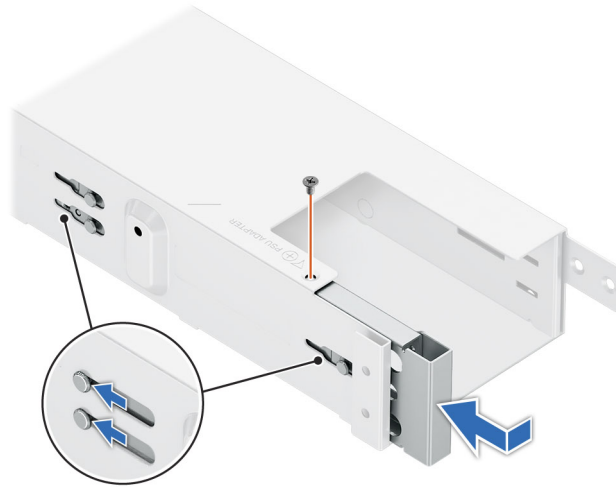

Figure 261. Installing the left PSU filler

3. Align the guides on the filler with the slots on the PSU cage and slide the filler, until the latch is locked with the PSU cage.

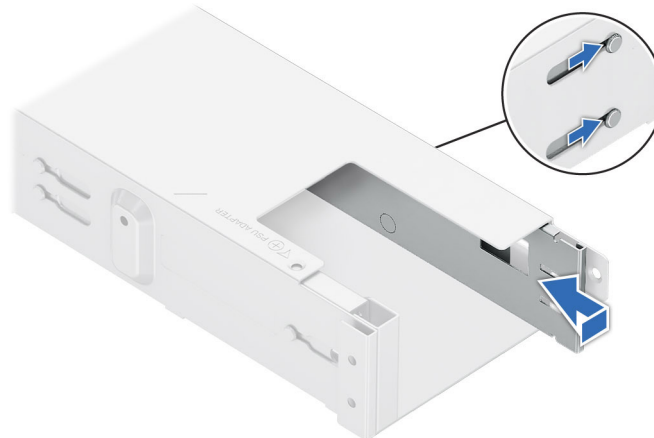

Figure 262. Installing the right PSU filler

Next steps

1. [Install the PSU](#) or [install the PSU blank](#).
2. Follow the procedure listed in [After working inside your system](#).

Trusted Platform Module

TPM is soldered down to the DC-SCM.

If the Trusted Platform Module (TPM) is identified as the root cause of the problem, a full DC-SCM replacement is necessary.

For more information on TPM see [Trusted Platform Module \(TPM\) Summary](#).

Initializing TPM 2.0 for users

Steps

1. Initialize the TPM.
 - a. While booting your system, press F2 to enter System Setup.
 - b. On the **System Setup Main Menu** screen, click **System BIOS > System Security Settings**.
 - c. From the **TPM Security** option, select **On**.
 - d. Save the settings.
 - e. Restart your system.
2. The **TPM Status** changes to **Enabled, Activated**.

HPM board

This is a service technician replaceable part only.

 **NOTE:** System board is know as Host Processor Module (HPM) board.

Removing the HPM board

Prerequisites

 **CAUTION:** If you are using the Trusted Platform Module (TPM) with an encryption key, you may be prompted to create a recovery key during program or System Setup. Be sure to create and safely store this recovery key. If you replace this HPM board, you must supply the recovery key when you restart your system or program before you can access the encrypted data on your drives.

1. Follow the safety guidelines listed in the [Safety instructions](#).
2. Follow the procedure listed in the [Before working inside your system](#).
3. Remove the following components:
 - a. [Air shroud](#)
 - b. [Cooling fans](#)
 - c. [Memory modules](#)
 - d. [Rear expansion card risers](#) or [rear expansion card riser blanks](#)
 - e. [Processor and heat sink module](#)
 - f. [Rear OCP](#) if installed
 - g. [Rear BOSS-N1 DC-MHS](#) if installed
 - h. [DC-SCM](#)
 - i. [Internal USB memory key](#) if installed
 - j. [Power supply units \(PSU\)](#)
 - k. Disconnect all the cables from the HPM board and make note of all the cable connections.

 **CAUTION:** Take care not to damage the system identification button while removing the HPM board from the system.

 **CAUTION:** Do not lift the system board by holding a memory module, processor, or other components.

Steps

1. Using the HPM board holder and plunger, slide the HPM board towards the front of the system.
2. Securely hold the holder and plunger to carefully lift the HPM board out of the chassis.

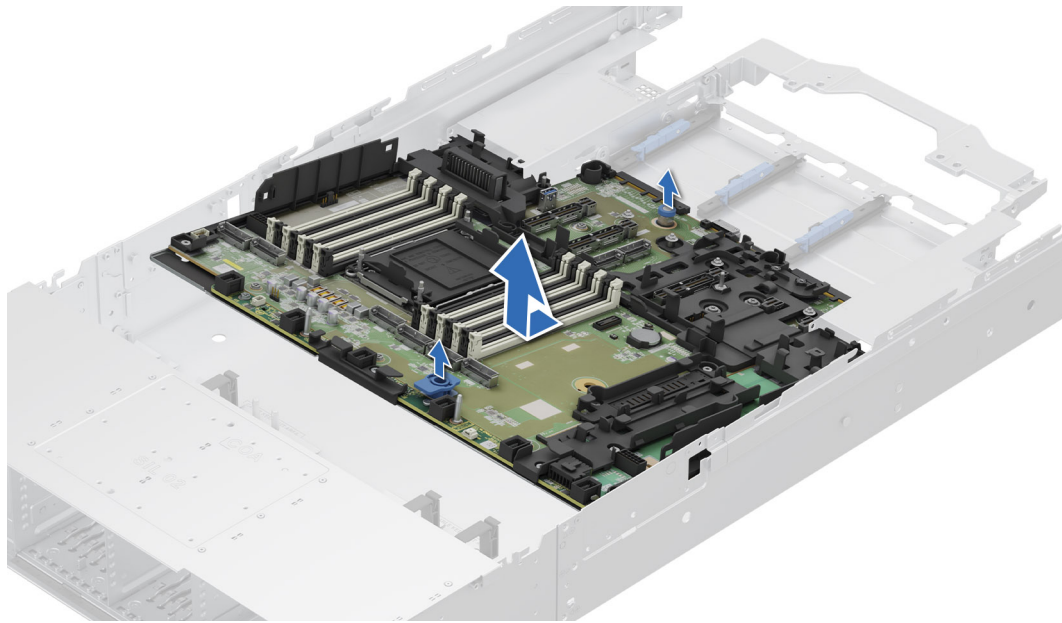

Figure 263. Removing the HPM board

Next steps

1. [Install the HPM board.](#)

Installing the HPM board

Prerequisites

1. Follow the safety guidelines listed in the [Safety instructions](#).
2. Follow the procedure listed in [Before working inside your system](#).
3. If you are replacing the HPM board, remove all the components that are listed in the removing the HPM board section.

Steps

1. Unpack the new HPM board assembly.

 **CAUTION: Do not lift the system board by holding a memory module, processor, or other components.**

 **CAUTION: Take care not to damage the system identification button while placing the HPM board into the chassis.**

2. Holding the HPM board holder and plunger, align and lower the HPM board into the system.
3. Slide the HPM board towards the rear of the chassis until the connectors are firmly seated in the slots.

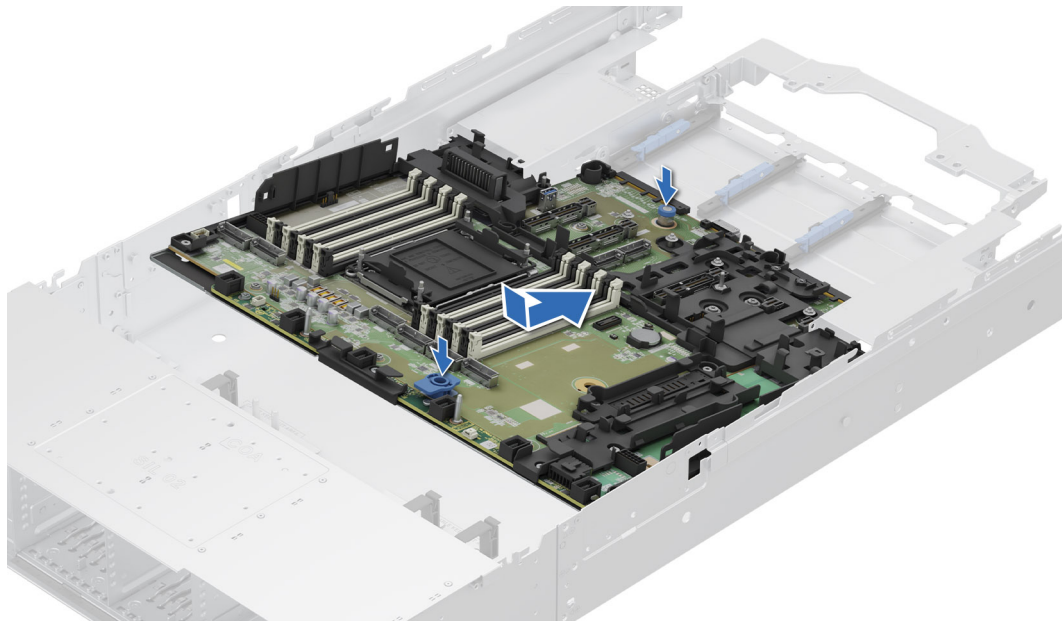

Figure 264. Installing the HPM board

Next steps

1. Replace the following components:
 - a. [Internal USB memory key](#) if removed
 - b. [Rear OCP card](#) if removed
 - c. [Rear BOSS-N1 DC-MHS](#) if removed
 - d. [DC-SCM](#)
 - e. [Processor and heat sink module](#)
 - f. [Memory modules](#)
 - g. [Rear expansion card risers](#) or [rear expansion card riser blanks](#)
 - h. [Cooling fans](#)
 - i. [Air shroud](#)
 - j. [Power supply units \(PSU\)](#)
2. Reconnect all cables to the HPM board.

i **NOTE:** Ensure that the cables inside the system are routed along the chassis wall and secured using the cable securing bracket.

3. Follow the procedure listed in [After working inside your system](#).

Control panel

This is a service technician replaceable part only.

Removing the right control panel (RCP) - Primary

Prerequisites

1. Follow the safety guidelines listed in the [Safety instructions](#).
2. Follow the procedure listed in the [Before working inside your system](#).
3. [Remove the drive backplane cover](#).
4. If installed, [remove the air shroud](#).
5. [Remove the cooling fan cage assembly](#).
6. [Remove the side wall bracket](#).

Steps

1. Using the Phillips 1 screwdriver, remove the screws that secure the right control panel and cable cover to the system.
2. Remove the cable cover away from the system.
3. Disconnect the right control panel cable from the connector on the system board.
4. Holding the right control panel cable assembly, slide the right control panel out of the system.

NOTE: Observe the routing of the cable assembly as you remove the right control panel from the system.

NOTE: The numbers on the image do not depict the exact steps. The numbers are for representation of sequence.

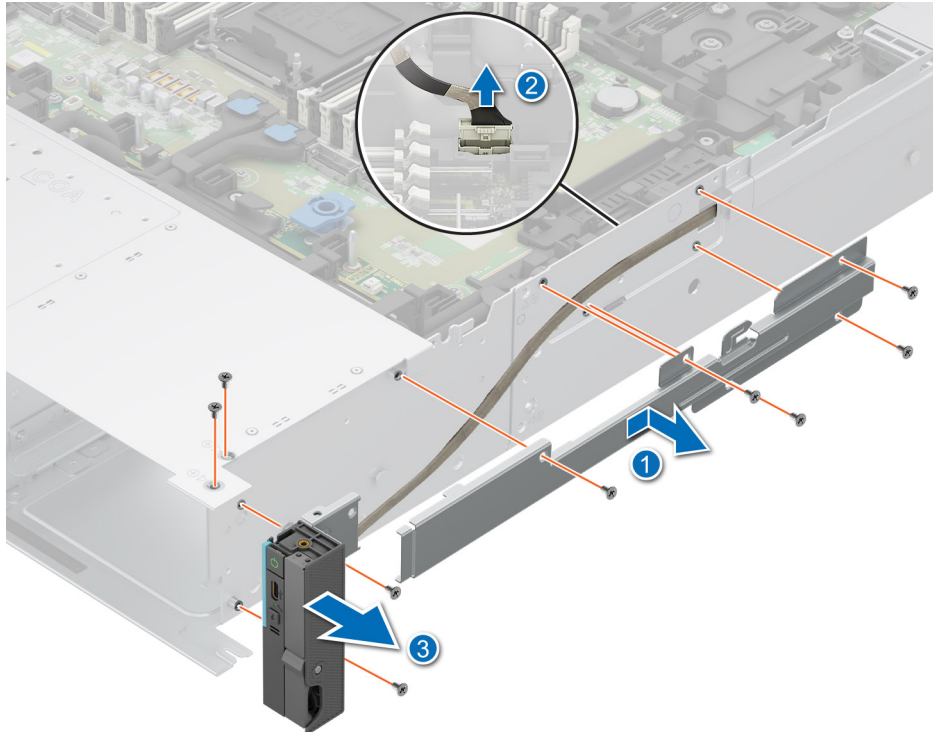

Figure 265. Removing the right control panel - primary

Next steps

1. [Replace the right control panel - primary.](#)

Installing the Right Control Panel (RCP) - Primary

Prerequisites

1. Follow the safety guidelines listed in the [Safety instructions](#).
2. Follow the procedure listed in the [Before working inside your system](#).
3. [Remove the drive backplane cover.](#)
4. If installed, [remove the air shroud.](#)
5. [Remove the cooling fan cage assembly.](#)
6. [Remove the side wall bracket.](#)

Steps

1. Align and slide the right control panel into the slot on the system.
2. Route the right control panel cable through the side wall of the system.
3. Align and slide the right control panel cable cover in the slot on the system.

NOTE: Route the cable properly to prevent the cable from being pinched or crimped.

4. Connect the right control panel cable to the connector on the system board.
5. Using the Phillips 1 screwdriver, tighten the screws that secure the right control panel and the cable cover to the system.

NOTE: The numbers on the image do not depict the exact steps. The numbers are for representation of sequence.

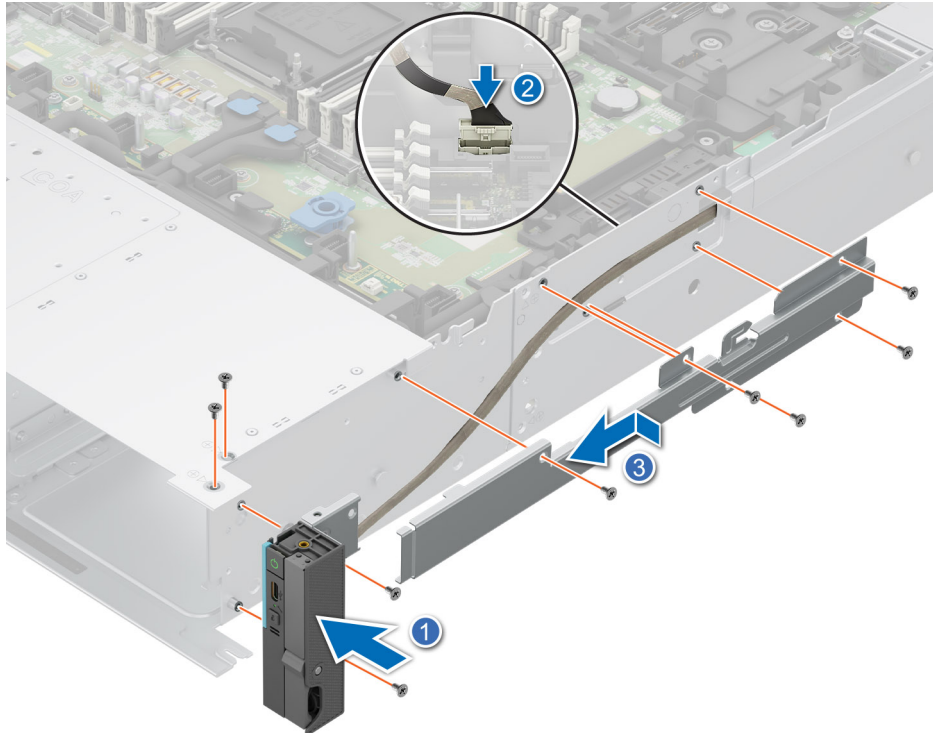

Figure 266. Installing the right control panel - primary

Next steps

1. Install the side wall bracket.
2. Install the cooling fan cage assembly.
3. Install the drive backplane cover.
4. Install the air shroud.
5. Follow the procedure listed in [After working inside your system](#).

Removing the KVM/Quick Sync Left Control Panel (LCP) - Secondary

Prerequisites

1. Follow the safety guidelines listed in the [Safety instructions](#).
2. Follow the procedure listed in the [Before working inside your system](#).
3. [Remove the drive backplane cover](#).
4. If installed, [remove the air shroud](#).
5. [Remove the cooling fan cage assembly](#).
6. [Remove the side wall bracket](#).
7. [Remove the rear expansion card risers](#) or the [rear expansion card riser blanks](#)

Steps

1. Using the Phillips 1 screwdriver, remove the screws that secure the left control panel and the cable cover to the system.

2. Remove the cable cover away from the system.
3. Disconnect the control panel cable from the connector on the HPM/Attic board.
4. Holding the cable, slide the left control panel out of the system.

NOTE: Observe the routing of the cable as you remove the left control panel from the system.

NOTE: See the [cable routing](#) section.

NOTE: The numbers on the image do not depict the exact steps. The numbers are for representation of sequence.

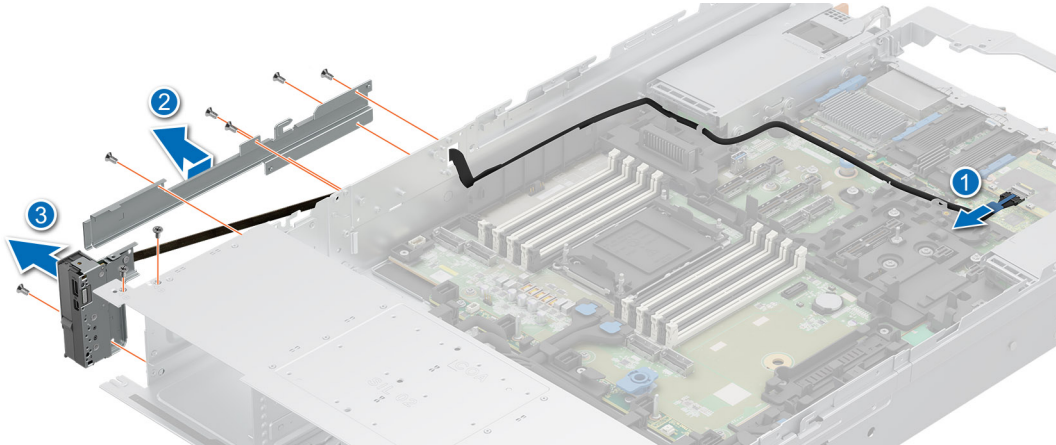

Figure 267. Removing the KVM left control panel

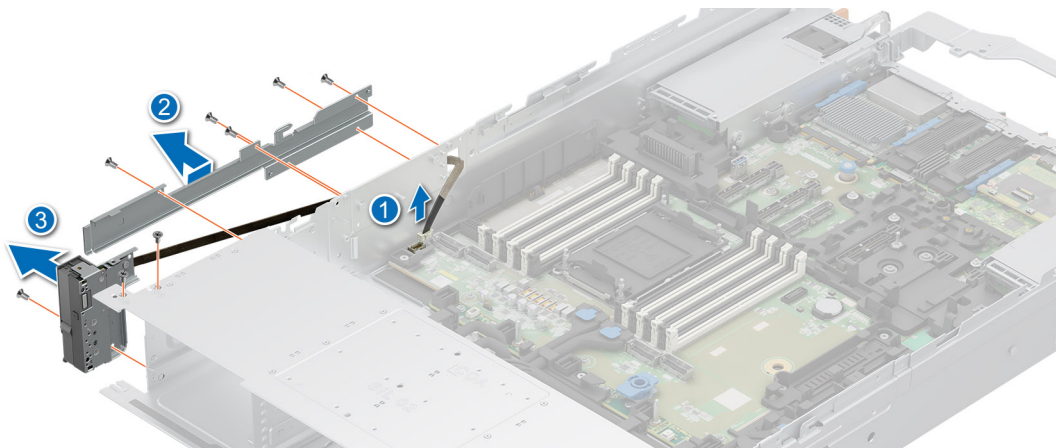

Figure 268. Removing the Quick Sync left control panel

Next steps

1. Replace the KVM/Quick Sync Left Control Panel - Secondary.

Installing the KVM/Quick Sync Left Control Panel (LCP) - Secondary

Prerequisites

1. Follow the safety guidelines listed in the [Safety instructions](#).
2. Follow the procedure listed in the [Before working inside your system](#).
3. [Remove the drive backplane cover](#).
4. If installed, [remove the air shroud](#).

5. Remove the cooling fan cage assembly.
6. Remove the side wall bracket.
7. Remove the rear expansion card risers or the rear expansion card riser blanks

Steps

1. Align and slide the left control panel in the slot on the system.
 2. Route the left control panel cable through the side wall of the system.
 3. Align and slide the left control panel cable cover in the slot on the system.
- NOTE:** Route the cable properly through the chassis side holder and the clips to prevent the cable from being pinched or crimped.
- NOTE:** See the [cable routing](#) section.
4. Connect the left control panel cable to the connector on the HPM/Attic board .
 5. Using the Phillips 1 screwdriver, tighten the screws to secure the left control panel and the cable cover to the system.
- NOTE:** The numbers on the image do not depict the exact steps. The numbers are for representation of sequence.

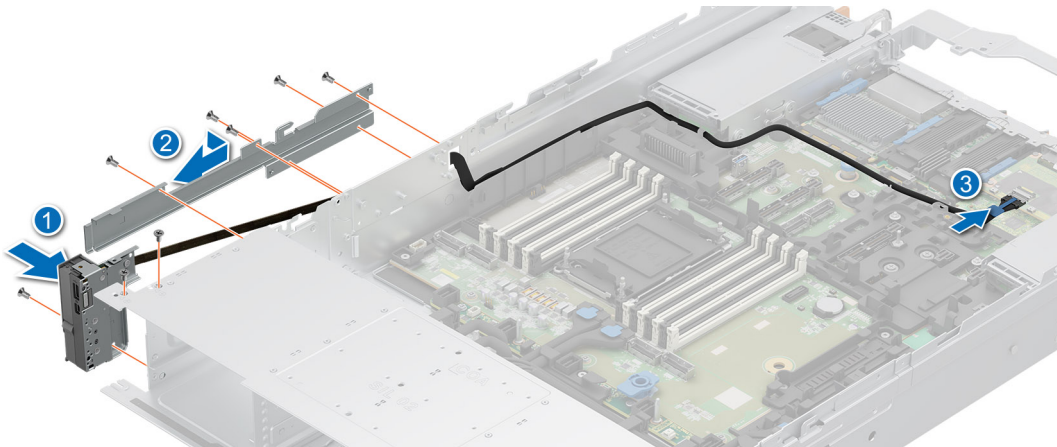

Figure 269. Installing the KVM left control panel

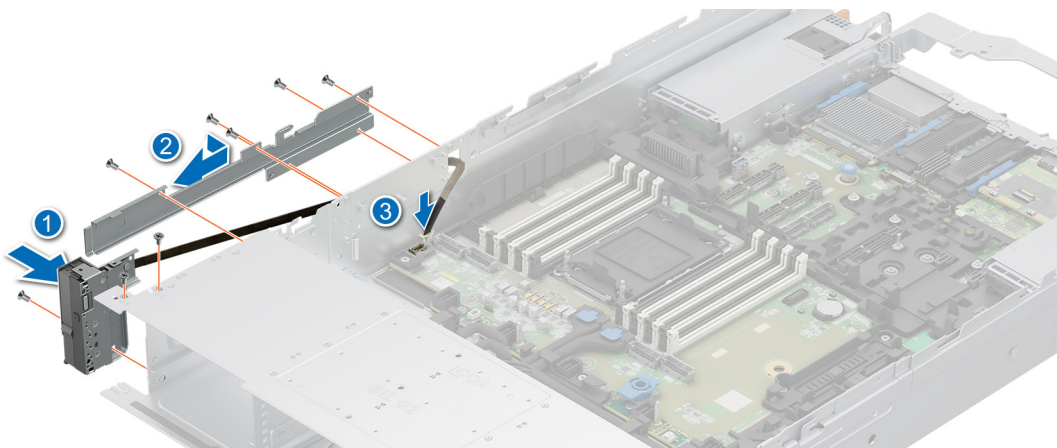

Figure 270. Installing the Quick Sync left control panel

Next steps

1. Install the side wall bracket.
2. Install the rear expansion card risers or the rear expansion card riser blanks
3. Install the cooling fan cage assembly.

4. Install the drive backplane cover.
5. Install the air shroud.
6. Follow the procedure listed in [After working inside your system](#).

Upgrade Kits

The table lists the available After Point Of Sale [APOS] kits.

Table 99. Upgrade kits

Kits	Related links to service instructions
Memory	See Installing a memory module
SSD	See Installing a drive
Processor	See Installing a processor
Power supplies	See Installing a power supply unit
Cables	See Cable routing

Topics:

- [Processor upgrade kit components](#)
- [GPU upgrade kit](#)
- [M.2 Interposer kit](#)
- [BOSS-N1 DCHMS module kit](#)
- [PERC module kit](#)

Processor upgrade kit components

The system supports only one processor.

Before you begin the installation or removal process, follow the [safety guidelines](#) and [before working inside the system](#) instructions.

Table 100. Processor upgrade kit components matrix

System configuration	CPU	Heatsink	FAN
8 x EDSFF E3.S drives	1	1 x HPR heatsink for CPU TDP > 150 W	5 x HPR Silver fan for CPU TDP > 150 W
8 x 2.5-inch SATA/NVMe Drives	1	1 x HPR heatsink for CPU TDP > 150 W	5 x HPR Silver fan for CPU TDP > 150 W
12 x 3.5-inch SATA Drives	1	1 x HPR heatsink for CPU TDP > 150 W	6 x HPR Gold fan for CPU TDP > 150 W

For installation procedures of the Heatsink and Processor see: [Processor and heat sink](#) section.

 **NOTE:** The install procedure for the remote and extended heatsinks are the same.

Processor upgrade guidelines

Procedure for switching between Intel® Xeon® E-Core processor and Intel® Xeon® P-core processor

1. Before the processor upgrade, ensure that the system has been upgraded to the latest BIOS, iDRAC, and FPGA version. See [Processor specifications](#) for more details.
2. Power off the system and follow the below steps to clear the NVRAM
 - a. Remove the power cords from all the power supply units.
 - b. Remove the [system cover](#), [air shrouds](#), and all [the rear risers](#) (if applicable).
 - c. Replace the Intel® Xeon® E-Core processor with the Intel® Xeon® P-core processor. For processor remove and installation, see [Processor and heat sink](#).
 - d. Toggle the DIP switch 1 to 'ON' state as shown below. For the DIP switch location on the HPM board see, [HPM board jumper settings](#).

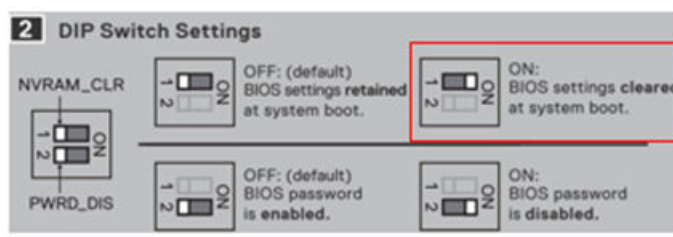

Figure 271. Image showing the 'ON' state

- e. Replace the [system cover](#), [the air shrouds](#), and all [the rear risers](#) (if applicable).
- f. Connect the power cords to the power supply units, and power on the system.
- g. When the system displays the **UEFI0033** message on the BIOS post screen as below, power off the system and disconnect the power cords from the all the power supply units.

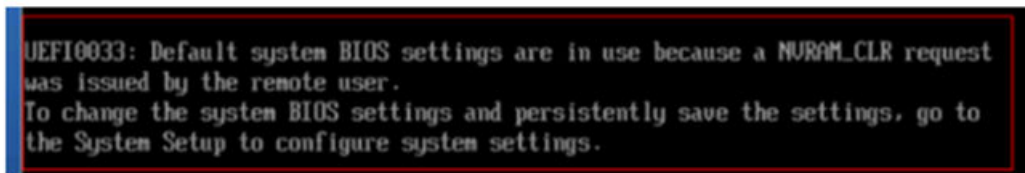

Figure 272. BIOS POST screen

- h. Remove the [system cover](#), [air shrouds](#), and all [the rear risers](#) (if applicable).
- i. Toggle the DIP switch 1 to "Off" state as shown below. For the DIP switch location on the HPM board see [HPM board jumper settings](#).

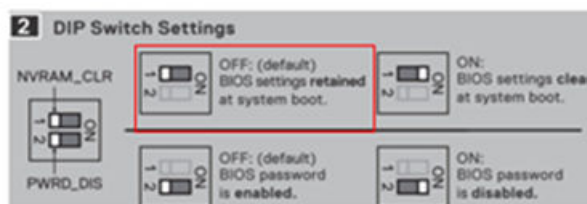

Figure 273. Image showing the 'OFF' state

- j. Replace the [system cover](#), [the air shrouds](#), and all [the rear risers](#) (if applicable).
- k. Connect the power cords to all the power supply units, power on the system and boot normally.

NOTE: The process is the same when replacing an Intel® Xeon® P-Core processor with an Intel® Xeon® E-core processor.

GPU upgrade kit

The GPU FL kit is available for the Customer. Depending on the kit ordered, the respective components are available.

CAUTION: Do not install GPUs, network cards, or other PCIe devices on your system that are not validated and tested by Dell. Damage caused by unauthorized and invalidated hardware installation will null and void the system warranty.

WARNING: Consumer-Grade GPU should not be installed or used in the Enterprise Server products.

Table 101. Components in the full length (FL) GPU kit

Components	GPU FL kit	
	Details	Quantity
Risers	Riser configuration (RC) 6, 8	RC6: Rear 1 x16 Onboard OCP + 1 x16 FH(Gen5) + 3 x16 DW FL(Gen5) + x4 Optional BOSS-N1 RC8: Front: 1 x16 FH(Gen5) + 1 x16 FLOP OCP + x4 Optional BOSS-N1 Rear: 1 x16 FH(Gen5) + 2 x16 DW FL(Gen5)
Shroud	GPU shroud	1
Fans	HPR GOLD fan	6
Heat sinks	1Uheat sink	RC: 6, 8
Cables	Power cable	2 x 6 + 1 x 4 (12-position + 4-sideband)

FL - Full Length, HL - Half Length, HPR - High Performance, RC - Riser configuration

- NOTE:** All DW GPU cards require 1U height heat sink, HPR Gold fans and GPU shroud.
- NOTE:** The riser configuration 6 supports DW GPU on slots 7, 4, 2 and riser configuration 8 supports DW GPU on slot 7, 2.
- NOTE:** H100 NVL GPU can't be supported in 12 x 3.5 inch drive, 24 x 2.5 inch drive and 32 x E3>S EDSFF drive configurations.
- NOTE:** See [expansion card installation guidelines](#) for more information about riser configuration supported for the system.
- NOTE:** H100 NVL GPU can be supported at max ambient 35C. However, with 350 W CPU SKUs, it is limited at max ambient 30C support.
- NOTE:** DW GPU is only supported in Cold aisle 8x E3 config.

Before you begin, follow the [safety guidelines](#) and [before working inside the system](#) instructions.

1. Remove the standard or High Performance Silver (HPR) cooling fans and install the High performance Gold (HPR) cooling fans.
 - NOTE:** For more information about supported cooling fans matrix, see the [thermal restriction matrix](#) section.
2. Remove the air shroud.
3. Remove the processor and heat sink module and also remove the processor.
4. Install the processor on GPU heat sink and install the processor and heat sink module.
5. Install the GPU air shroud.
6. Install the GPU into full length risers.
 - NOTE:** See [installing full length expansion card riser](#) into the system.

NOTE: For information about riser slot location on the system board, see the [System board jumpers and connectors](#) section.

- If applicable, connect the power cables to the GPU. To know the connectors for the GPU on the system board, see the [System board jumpers and connectors](#) section.

See the GPU power cable matrix to know about the requirement of cables for the GPU.

For routing of cales see [Cable Routing](#) .

Table 102. GPU power cable matrix

Category	Supported GPUs	Type	Vendor	Cable	Cable quantity
GPU	NVIDIA L4	HL (FH and LP brackets)	NVIDIA	Not required	Not required
GPU	NVIDIA H100 NVL and L40S	FH and FL	NVIDIA	12VH type 2 x 6 + 1 x 4 (12-position + 4-sideband) 	Riser 6 up to 3 and Riser 8 up to 2
HL - Half Length, FH - Full Height, FL - Full Length					

- Install the [full length expansion card riser](#).

After installing, follow the [After working inside the system](#) instructions.

M.2 Interposer kit

The M.2 interposer module supports up to two M.2 NVMe SSDs. On the PowerEdge R570 M.2 Interposer modules are supported at the front and rear.

Before you begin the installation or removal process, follow the [safety guidelines](#) and [before working inside the system](#) instructions.

Table 103. M.2 Interposer module kit components - Front

Components in kit	R570 (quantity)
M.2 Interposer controller card module	1
M.2 Interposer front tray	1
M.2 NVMe SSD	1 or 2
M.2 NVMe SSD capacity label	1 or 2
M.2 Interposer PCIe cable with holder	1

Table 104. M.2 Interposer module kit components - Rear

Components in kit	R570 (quantity)
M.2 Interposer controller card module	1
M.2 NVMe SSD	1 or 2
M.2 NVMe SSD capacity label	1 or 2

For installation procedures of the M.2 Interposer modules see: [Installing the M.2 Interposer board](#) section.

NOTE: See [cable routing](#) section, for more information about connecting the cables to HPM board connectors.

BOSS-N1 DCHMS module kit

The BOSS-N1 DCHMS module supports up to two M.2 NVMe SSDs. On the PowerEdge R570 BOSS-N1 DCHMS modules are supported at the front and rear.

Before you begin the installation or removal process, follow the [safety guidelines](#) and [before working inside the system](#) instructions.

Table 105. BOSS-N1 DCHMS module kit components - Front

Components in kit	R570 (quantity)
BOSS-N1 DCHMS controller card module	1
BOSS-N1 DCHMS card carrier	2
M.2 NVMe SSD	2
M.2 NVMe SSD capacity label	2
BOSS-N1 DCHMS card carrier blank	1
BOSS-N1 DCHMS PCIe cable with holder	1

Table 106. BOSS-N1 DCHMS module kit components - Rear

Components in kit	R570 (quantity)
BOSS-N1 DCHMS controller card module	1
BOSS-N1 DCHMS controller card module	1
BOSS-N1 DCHMS card carrier	2
M.2 NVMe SSD	2
M.2 NVMe SSD capacity label	2
BOSS-N1 DCHMS card carrier blank	1

For installation procedures of the BOSS-N1 DCHMS modules see: [Optional BOSS-N1 DC-MHS module](#) section.

 **NOTE:** See [cable routing](#) section, for more information about connecting the BOSS cables to HPM board connectors.

PERC module kit

Before you begin the installation or removal process, follow the [safety guidelines](#) and [before working inside the system](#) instructions.

Table 107. PERC module kit components - Front (H965i)

Components in kit	R570 (quantity)
Tray	1
H965i Front	1
Shroud	1
Screw 3 x 8.5 mm	4
PCIE cable	2
PERC cable	2
Power cable	1

Table 108. PERC module kit components - Front (H365i)

Components in kit	R570 (quantity)
Tray	1
H365i Front	1
Shroud	1
Screw 3 x 8.5 mm	4
PCIe cable	1
PERC cable	2
Power cable	1

Table 109. PERC upgrade Kit cable connections

Backplane configuration	Riser configuration	Upgrade from:	Upgrade to:	Disconnect and remove card or cables from the connector (cable marking):	Replace with the card or cables (cable marking):
8 x 2.5-inch NVMe	RC 0	Onboard PCIe	H365i front	<ul style="list-style-type: none"> • PCIe cable 1 (HPM_SL1/SL2 – BP_DST_PA1/ BP_DST) • PCIe cable 2 (HPM_SL3/SL4 – BP_DST_PA2/ BP_DST_PB2) 	<ul style="list-style-type: none"> • Add H365i card • PCIe cable1 (HPM_SL3 – CTRL_DST_PA 1) • PERC cable 1 (CTRL_SRC_S A1 – BP_DST_PA1) • PERC cable 2 (CTRL_SRC_P B1 – BP_DST_PA2/ BP_DST_PB2) • PERC power cable (BP_PWR_CT RL - CTRL_PWR_1)
8 x 2.5-inch NVMe	RC 0	Onboard PCIe	H965i front	<ul style="list-style-type: none"> • PCIe cable 1 (HPM_SL1/SL2 – BP_DST_PA1/ BP_DST) • PCIe cable 2 (HPM_SL3/SL4 – BP_DST_PA2/ BP_DST_PB2) 	<ul style="list-style-type: none"> • Add H965i card • PCIe cable1 (HPM_SL1/SL2 – CTRL_DST_PA 1/ CTRL_DST_PB 1) • PERC cable 1 (CTRL_SRC_S A1_PA1 – BP_DST_PA1/ BP_DST_PB1) • PERC cable 2 (CTRL_SRC_P B1 – BP_DST_PA2/ BP_DST_PB2) • PERC power cable (BP_PWR_CT

Table 109. PERC upgrade Kit cable connections (continued)

Backplane configuration	Riser configuration	Upgrade from:	Upgrade to:	Disconnect and remove card or cables from the connector (cable marking):	Replace with the card or cables (cable marking):
					RL - CTRL_PWR_1)
8 x 2.5-inch SATA	RC 1, RC 5	H365i	H965i front	N/A	<ul style="list-style-type: none"> • Add H965i card • PCIe cable1 (HPM_SL3 – CTRL_DST_PA 1) • PCIe cable1 (HPM_SL4 – CTRL_DST_PB 1) • PERC cable 1 (CTRL_SRC_S A1 - BP_DST_SA1) • PERC power cable (BP_PWR_CTL RL - CTRL_PWR_1)
8 x 2.5-inch NVMe	RC 0, RC 1, RC 5	H365i	H965i front	N/A	<ul style="list-style-type: none"> • Add H965i card • PCIe cable1 (HPM_SL3 – CTRL_DST_PB 1) • PCIe cable1 (HPM_SL34– CTRL_DST_PA 1) • PERC cable (CTRL_SRC_P A1 - BP_DST_PA1) • PER cable (CTRL_SRC_P B1 - BP_DST_PA1) • PERC power cable (BP_PWR_CTL RL - CTRL_PWR_1)
16 x 2.5-inch NVMe	RC 0, RC 1, RC 5	H365i	H965i front	N/A	<ul style="list-style-type: none"> • Add H965i card • PCIe cable1 (HPM_SL3 – CTRL_DST_PB 1) • PCIe cable1 (HPM_SL34– CTRL_DST_PA 1) • PERC cable (CTRL_SRC_P

Table 109. PERC upgrade Kit cable connections (continued)

Backplane configuration	Riser configuration	Upgrade from:	Upgrade to:	Disconnect and remove card or cables from the connector (cable marking):	Replace with the card or cables (cable marking):
					A1 - BP_DST_PA1) • PER cable (CTRL_SRC_P B1 - BP_DST_PA1) • PERC power cable (BP_PWR_CTRL - CTRL_PWR_1)

For installation procedures of the PERC modules see: [PERC cards](#) section.

i **NOTE:** See [cable routing](#) section, for more information about connecting the PERC cables to HPM board connectors.)

System diagnostics and indicator codes

The diagnostic indicators on the system front panel display system status during system startup.

Topics:

- [Power button LED](#)
- [System health and system ID indicator codes](#)
- [iDRAC Direct LED indicator codes](#)
- [iDRAC Quick Sync 2 indicator codes](#)
- [NIC indicator codes](#)
- [Power supply unit indicator codes](#)
- [Drive indicator codes](#)
- [Using system diagnostics](#)

Power button LED

The power button LED is on the front panel of your system.



Figure 274. Power button LED

Table 110. Power button LED

Power button LED indicator code	Condition
Off	System is not operating or idle in standby power mode regardless of the power supply available.
On	System is operating, one or more of the non-standby power supply units are active.
Slowly blinking	System is performing powering on sequence, and is still booting.

System health and system ID indicator codes

The system health and system ID indicator is located on the right control panel of the system.



Figure 275. System health and system ID indicator

Table 111. System health and system ID indicator codes

System health and system ID indicator code	Condition
Solid blue	Indicates that the system is powered on, is healthy, and system ID mode is not active. Press the system ID button to switch to system ID mode.
Blinking blue	Indicates that the system ID mode is active. Press the system ID button to switch to system health mode.
Blinking amber	Indicates that the system is experiencing a fault. Check the System Event Log for specific error messages. EEMI guide

iDRAC Direct LED indicator codes

The iDRAC Direct LED indicator lights up to indicate that the port is connected and is being used as a part of the iDRAC subsystem.

You can configure iDRAC Direct by using a USB to micro USB (type AB) cable, which you can connect to your laptop or tablet. Cable length should not exceed 3 feet (0.91 meters). Performance could be affected by cable quality. The following table describes iDRAC Direct activity when the iDRAC Direct port is active:

Table 112. iDRAC Direct LED indicator codes

iDRAC Direct LED indicator code	Condition
Solid green for two seconds	Indicates that the laptop or tablet is connected.
Blinking green (on for two seconds and off for two seconds)	Indicates that the laptop or tablet connected is recognized.
LED Indicator off	Indicates that the laptop or tablet is unplugged.

iDRAC Quick Sync 2 indicator codes

iDRAC Quick Sync 2 module (optional) is located on the left control panel front IO panel of the system.



Table 113. iDRAC Quick Sync 2 indicators and descriptions

iDRAC Quick Sync 2 indicator code	Condition	Corrective action
Off (default state)	Indicates that the iDRAC Quick Sync 2 feature is powered off. Press the iDRAC Quick Sync 2 button to power on the iDRAC Quick Sync 2 feature.	If the LED fails to power on, reseal the left control panel flex cable and check. If the problem persists, see the Getting help section.
Solid white	Indicates that iDRAC Quick Sync 2 is ready to communicate. Press the iDRAC Quick Sync 2 button to power off.	If the LED fails to power off, restart the system. If the problem persists, see the Getting help section.
Blinks white rapidly	Indicates data transfer activity.	If the indicator continues to blink indefinitely, see the Getting help section.
Blinks white slowly	Indicates that firmware update is in progress.	If the indicator continues to blink indefinitely, see the Getting help section.
Blinks white five times rapidly and then powers off	Indicates that the iDRAC Quick Sync 2 feature is disabled.	Check if iDRAC Quick Sync 2 feature is configured to be disabled by iDRAC. If the problem persists, see the Getting help section. PowerEdge manuals or <i>Dell OpenManage Server Administrator User's Guide</i> at OpenManage Manuals .
Solid amber	Indicates that the system is in fail-safe mode.	Restart the system. If the problem persists, see the Getting help section.
Blinking amber	Indicates that the iDRAC Quick Sync 2 hardware is not responding properly.	Restart the system. If the problem persists, see the Getting help section.

NIC indicator codes

Each NIC on the back of the system has indicators that provide information about the activity and link status. The activity LED indicator indicates if data is flowing through the NIC, and the link LED indicator indicates the speed of the connected network.

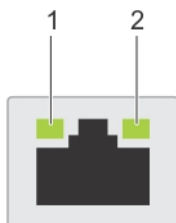

Figure 276. NIC indicator codes

1. Link LED indicator
2. Activity LED indicator

Table 114. NIC indicator codes

NIC indicator codes	Condition
Link and activity indicators are off.	Indicates that the NIC is not connected to the network.
Link indicator is green, and activity indicator is blinking green.	Indicates that the NIC is connected to a valid network at its maximum port speed, and data is being sent or received.
Link indicator is amber, and activity indicator is blinking green.	Indicates that the NIC is connected to a valid network at less than its maximum port speed, and data is being sent or received.
Link indicator is green, and activity indicator is off.	Indicates that the NIC is connected to a valid network at its maximum port speed, and data is not being sent or received.
Link indicator is amber, and activity indicator is off.	Indicates that the NIC is connected to a valid network at less than its maximum port speed, and data is not being sent or received.
Link indicator is blinking green, and activity is off.	Indicates that the NIC identity is enabled through the NIC configuration utility.

Power supply unit indicator codes

AC and DC power supply units (PSUs) have an illuminated translucent handle that serves as an indicator. The indicator shows if power is present or if a power fault has occurred.

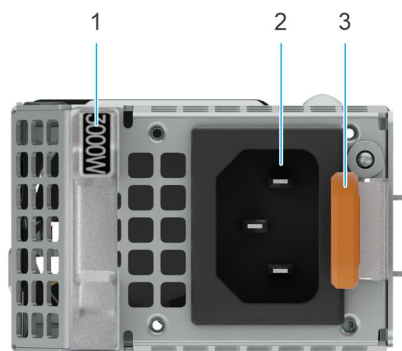

Figure 277. AC PSU status indicator

1. AC PSU handle
2. Socket
3. Release latch

Table 115. AC and DC PSU status indicator codes

Power indicator codes	Condition
Green	Indicates that a valid power source is connected to the PSU and the PSU is operational.
Blinking amber	Indicates an issue with the PSU.
Not powered on	Indicates that the power is not connected to the PSU.
Blinking green	Indicates that the firmware of the PSU is being updated. ⚠ CAUTION: Do not disconnect the power cord or unplug the PSU when updating firmware. If firmware update is interrupted, the PSUs will not function.
Blinking greens and powers off	When hot-plugging a PSU, it blinks green five times at a rate of 4 Hz and powers off. This indicates a PSU mismatch due to efficiency, feature set, health status, or supported voltage. ⚠ CAUTION: If two PSUs are installed, both the PSUs must have the same type of label; for example,

Table 115. AC and DC PSU status indicator codes (continued)

Power indicator codes	Condition
	<p>Extended Power Performance (EPP) label. Mixing PSUs from previous generations of PowerEdge servers is not supported, even if the PSUs have the same power rating. This results in a PSU mismatch condition or failure to power on the system.</p> <p>⚠ CAUTION: If two PSUs are used, they must be of the same type and have the same maximum output power.</p> <p>⚠ CAUTION: When correcting a PSU mismatch, replace the PSU with the blinking indicator. Swapping the PSU to make a matched pair can result in an error condition and an unexpected system shutdown. To change from a high output configuration to a low output configuration or vice versa, you must power off the system.</p> <p>⚠ CAUTION: AC PSUs support both 240 V and 120 V input voltages with the exception of Titanium PSUs, which support only 240 V. When two identical PSUs receive different input voltages, they can output different wattages, and trigger a mismatch.</p>

Drive indicator codes

The LEDs on the drive carrier indicate the state of each drive. SAS/SATA drive carrier has two LEDs: an activity LED (green) and a status LED (bicolor, green/amber). The activity LED blinks whenever the drive is accessed. The LEDs on the EDSFF E3.S drive have two LEDs: an activity LED (green) and a locate/fault LED (blue/amber). The activity LED blinks whenever the drive is accessed



Figure 278. SAS/SATA Drive indicators

1. Drive activity LED indicator
2. Drive status LED indicator
3. Drive capacity label

NOTE: If the drive is in the Advanced Host Controller Interface (AHCI) mode, the status LED indicator does not power on.

NOTE: Drive status indicator behavior is managed by Storage Spaces Direct. Not all drive status indicators may be used.

Table 116. Drive indicator codes

Drive status indicator code	Condition
Blinks green twice per second	Indicates that the drive is being identified or preparing for removal.
Not powered on	Indicates that the drive is ready for removal.

Table 116. Drive indicator codes (continued)

Drive status indicator code	Condition
	NOTE: The drive status indicator remains off until all drives are initialized after the system is powered on. Drives are not ready for removal during this time.
Blinks green, amber, and then powers off	Indicates that there is an unexpected drive failure.
Blinks amber four times per second	Indicates that the drive has failed.
Blinks green slowly	Indicates that the drive is rebuilding.
Solid green	Indicates that the drive is online.
Blinks green for three seconds, amber for three seconds, and then powers off after six seconds	Indicates that the rebuild has stopped.



Figure 279. EDSFF E3.S drive indicators

1. Drive activity LED indicator
2. Drive status LED indicator
3. Drive capacity label

EDSFF E3.S drive led codes

E3.S hard drives have Green LED and Blue/Amber LED.

- Green LED shows : Drive power status , Activity
- Blue/Amber LED shows: Drive Fault, Locate

EDSFF indicator behavior

Table 117. EDSFF indicator behavior

Pattern Name	Description	Blue Element	Amber Element
Locate	This device is being identified.	ON (1 sec ON 1 sec OFF)	OFF
Fault	The device is in a fault condition.	OFF	ON (2 sec ON 1 sec OFF)
N/A	This device does not have fault or locate device.	OFF	OFF

NOTE: Locate behavior overrides Fault state.

Green LED

The green LED is driven and controlled by the device. The two functions for this LED are defined as follows:

- Power: This function indicates that the device has power and has no issues with its power regulation. Once the green LED is ON, it shall either remain ON or blink at the activity frequency unless the device determines power is no longer within its operating range.
- Activity: This function indicates if the device is being used.

Table 118. LED and device state per function for Green LED

Function/Device state	LED state
Power ON/Device is powered, no activity occurring.	ON

Table 118. LED and device state per function for Green LED (continued)

Function/Device state	LED state
Activity/Device is powered, host initiated I/O activity occurring.	4 Hz nominal blink rate
Power OFF/Device is not powered.	OFF

Using system diagnostics

If you experience an issue with the system, run the system diagnostics before contacting Dell for technical assistance. The purpose of running system diagnostics is to test the system hardware without using additional equipment or risking data loss. If you are unable to fix the issue yourself, service and support personnel can use the diagnostics results to help you solve the issue.

Dell Embedded System Diagnostics

NOTE: The Dell Embedded System Diagnostics is also known as Enhanced Pre-boot System Assessment (ePSA) diagnostics.

The Embedded System Diagnostics provide a set of options for particular device groups or devices allowing you to:

- Run tests automatically or in an interactive mode
- Repeat tests
- Display or save test results
- Run thorough tests to introduce additional test options to provide extra information about the failed device(s)
- View status messages that inform you if tests are completed successfully
- View error messages that inform you of issues encountered during testing

System diagnostic controls

Table 119. System diagnostic controls

Menu	Description
Configuration	Displays the configuration and status information of all detected devices.
Results	Displays the results of all tests that are run.
System health	Provides the current overview of the system performance.
Event log	Displays a time-stamped log of the results of all tests run on the system. This is displayed if at least one event description is recorded.

Jumpers and connectors

This topic provides some basic and specific information about jumpers and switches. It also describes the connectors on the various boards in the system. Jumpers on the HPM board help to disable the system and reset the passwords. To install components and cables correctly, you must know the connectors on the HPM board.

Topics:

- HPM board jumpers and connectors
- HPM board jumper settings
- Disabling a forgotten password

HPM board jumpers and connectors

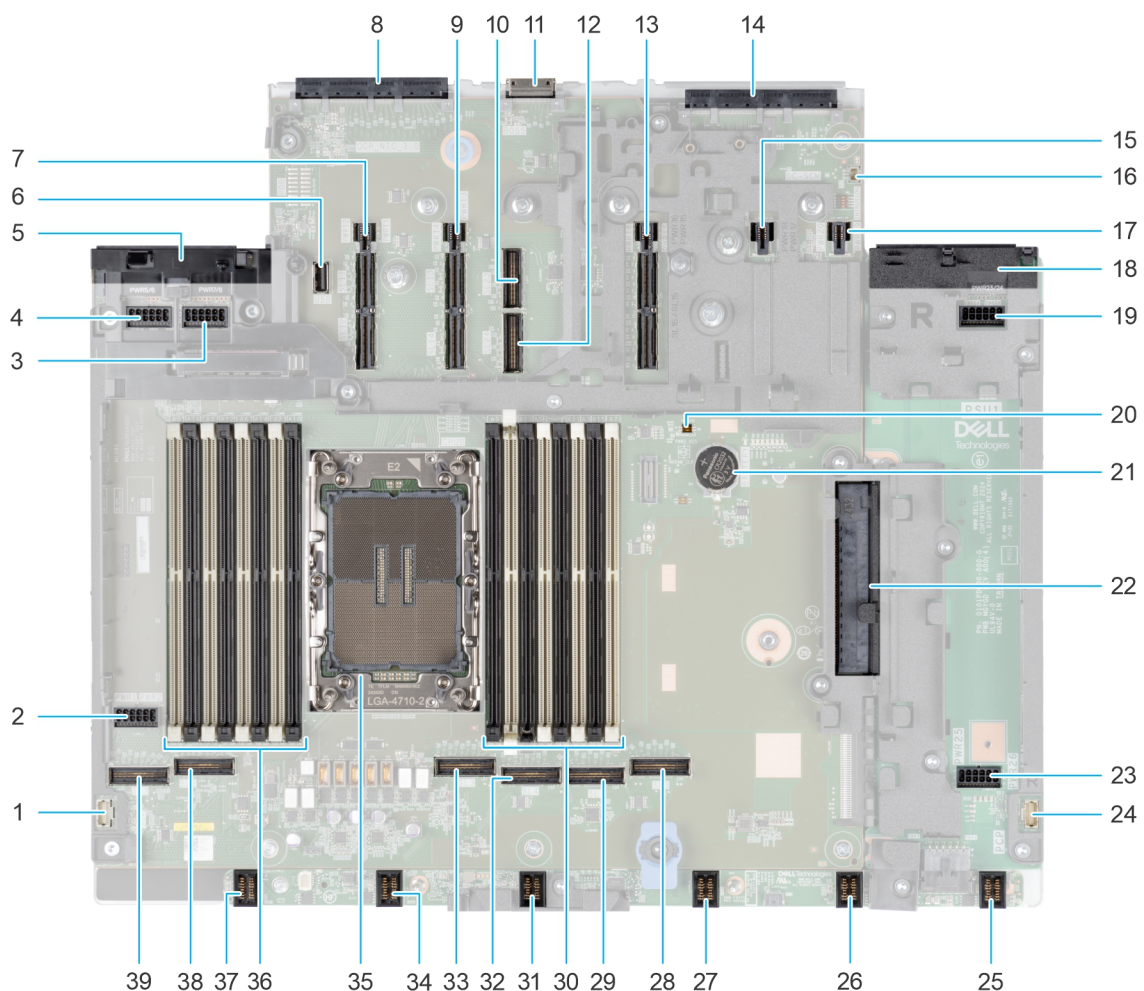

Figure 280. HPM board jumpers and connectors

Table 120. HPM board jumpers and connectors

Item	Connector
1.	Secondary Control Panel Connector

Table 120. HPM board jumpers and connectors (continued)

Item	Connector
2.	Power Connector 1/2 (PWR1/PWR2)
3.	Power Connector 7/8 (PWR7/PWR8)
4.	Power Connector 5/6 (PWR5/PWR6)
5.	PSU Connector 2
6.	Internal USB
7.	Riser Connector (SL11/SL12/PWR11/PWR12)
8.	OCP NIC 3.0 Connector
9.	Riser Connector (SL13/SL14/PWR13/PWR14)
10.	PCIe Connector 23 (SL23_CPU0)
11.	BOSS Connector
12.	PCIe Connector 24 (SL24_CPU0)
13.	Riser Connector (SL15/SL16/PWR15/PWR16)
14.	DC-SCM
15.	Riser Connector (PWR17/PWR18)
16.	Intrusion Switch Connector
17.	Riser Connector (PWR19/PWR20)
18.	PSU Connector 1
19.	Power Connector 23/24 (PWR23/PWR24)
20.	DIP Switch for NVRAM/PWRD
21.	Coin Cell Battery
22.	PIB Power Connector
23.	Power Connector 25/26 (PWR25/PWR26)
24.	Primary Control Panel Connector
25.	FAN 6
26.	FAN 5
27.	FAN 4
28.	PCIe Connector 6 (SL6_CPU0)
29.	PCIe Connector 5 (SL5_CPU0)
30.	DIMMS for CPU 0
31.	FAN 3
32.	PCIe Connector 4 (SL4_CPU0)
33.	PCIe Connector 3 (SL3_CPU0)
34.	FAN 2
35.	CPU 0
36.	DIMMS for CPU 0
37.	FAN 1
38.	PCIe Connector 2 (SL2_CPU0)

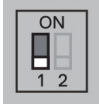

Table 120. HPM board jumpers and connectors (continued)

Item	Connector
39.	PCIe Connector 1 (SL1_CPU0)

HPM board jumper settings

For information about resetting the password jumper to disable a password, see the [Disabling a forgotten password](#) section.

Table 121. HPM board jumper settings

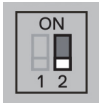
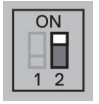
Jumper	Setting	Description
NVRAM_CLR		OFF (default): The BIOS settings are retained at system boot.
		ON: The BIOS settings cleared at system boot.
PWRD_DIS		OFF (default): The BIOS password is enabled.
		ON: The BIOS password is disabled.

CAUTION: Be careful when changing the BIOS settings. The BIOS interface is designed for advanced users. Any change in the setting could prevent your system from starting correctly and you might have potential loss of data.

Disabling a forgotten password

The software security features of the system include a system password and a setup password. The password jumper enables or disables password features and clears any password(s) currently in use.

Prerequisites

CAUTION: Many repairs may only be done by a certified service technician. You should only perform troubleshooting and simple repairs as authorized in your product documentation, or as directed by the online or telephone service and support team. Damage due to servicing that is not authorized by Dell is not covered by your warranty. Read and follow the safety instructions that are shipped with your product.

Steps

1. Power off the system, and all the attached peripherals, and disconnect the system from the electrical outlet.
2. Remove the system cover.
3. Move the DIP switch (PWRD_DIS) on the HPM board from OFF position to ON position.
4. Replace the system cover.

NOTE: The existing passwords are not disabled (erased) until the system boots the DIP switch in the ON position. However, before you assign a new system and/or setup password, you must move the DIP switch back to OFF position

 **NOTE:** If you assign a new system and/or setup password with the DIP switch in ON position, the system disables the new password(s) the next time it boots.

5. Reconnect the system and all the attached peripherals.
6. Power off the system.
7. Remove the system cover.
8. Move the DIP switch (PWRD_DIS) on the HPM board from ON position to OFF position.
9. Replace the system cover.
10. Reconnect the system to the electrical outlet and power on the system, and all the attached peripherals.
11. Assign a new system and/or setup password.

Getting Help

Topics:

- [Recycling or End-of-Life service information](#)
- [Contact Dell Technologies](#)
- [Accessing system information by using MyDell](#)
- [Receiving automated support with Secure Connect Gateway \(SCG\)](#)

Recycling or End-of-Life service information

Take back and recycling services are offered for this product in certain countries. If you want to dispose of system components, visit [How to Recycle](#) and select the relevant country.

Contact Dell Technologies

Dell provides online and mobile support and service options. If you do not have an active Internet connection, you can find Dell contact information on your invoice, packing slip, bill, or Dell product catalog. The availability of services varies depending on the country or region and product, and some services may not be available in your area. To contact Dell for sales, technical support, or customer service issues follow these steps:

Steps

1. Go to [Dell Support](#).
2. Select your country or region from the drop-down menu on the lower right corner of the page.
3. For customized support, enter the system Service Tag in the **Enter a Service Tag, Serial Number, Service Request, Model, or Keyword** field and click **Search**.
4. For general support, select your category, segment, or product.
5. For contact details of Dell Global Technical Support, click [Contact Technical Support](#):

Accessing system information by using MyDell

You can use the MyDell label located on the Express service tag in the front of the PowerEdge system, to access information about PowerEdge R570 system.

Prerequisites

Ensure that your smartphone or tablet has a QR code scanner installed.

The MyDell includes the following information about your system:

- How-to videos
- Reference materials, including the Installation and Service Manual, and mechanical overview.
- The system service tag to quickly access the specific hardware configuration and warranty information.
- A direct link to Dell to contact technical support and sales teams.

Steps

Go to product-specific page in [PowerEdge Manuals](#) or scan the model-specific QR code on your system using your smartphone or tablet.

QR code for PowerEdge R570 system resources

Figure 281. QR code for PowerEdge R570

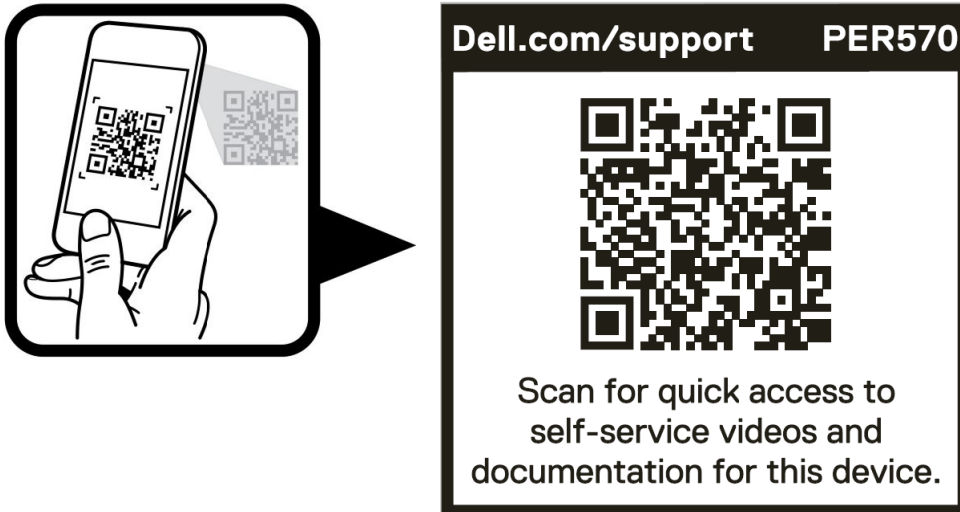

system

Receiving automated support with Secure Connect Gateway (SCG)

Dell Secure Connect Gateway (SCG) is an optional Dell Services offering that automates technical support for your Dell server, storage, and networking devices. By installing and setting up a Secure Connect Gateway (SCG) application in your IT environment, you can receive the following benefits:

- Automated issue detection — Secure Connect Gateway (SCG) monitors your Dell devices and automatically detects hardware issues, both proactively and predictively.
- Automated case creation — When an issue is detected, Secure Connect Gateway (SCG) automatically opens a support case with Dell Technical Support.
- Automated diagnostic collection — Secure Connect Gateway (SCG) automatically collects system state information from your devices and uploads it securely to Dell. This information is used by Dell Technical Support to troubleshoot the issue.
- Proactive contact — A Dell Technical Support agent contacts you about the support case and helps you resolve the issue.

The available benefits vary depending on the Dell Service entitlement purchased for your device. For more information about Secure Connect Gateway (SCG), go to [secureconnectgateway](https://www.dell.com/support/secureconnectgateway).

Documentation resources

This section provides information about the documentation resources for your system.

To view the document that is listed in the documentation resources table:

- From the Dell support site:
 1. Click the documentation link that is provided in the Location column in the table.
 2. Click the required product or product version.

 **NOTE:** To locate the model number, see the front of your system.

3. On the Product Support page, click **Documentation**.
- Using search engines:
 - Type the name and version of the document in the search box.

Table 122. Additional documentation resources for your system

Task	Document	Location
Setting up your system	<p>For more information about installing and securing the system into a rack, see the Rail Installation Guide included with your rail solution.</p> <p>For information about setting up your system, see the <i>Quick Start Guide</i></p>	PowerEdge manuals
Configuring your system	<p>For information about the iDRAC features, configuring and logging in to iDRAC, and managing your system remotely, see the Integrated Dell Remote Access Controller User's Guide.</p> <p>For information about understanding Remote Access Controller Admin (RACADM) subcommands and supported RACADM interfaces, see the RACADM CLI Guide for iDRAC .</p> <p>For information about Redfish and its protocol, supported schema, and Redfish Eventing implemented in iDRAC, see the Redfish API Guide.</p> <p>For information about iDRAC property database group and object descriptions, see the Attribute Registry Guide.</p>	PowerEdge manuals
	<p>For information about earlier versions of the iDRAC documents.</p> <p>To identify the version of iDRAC available on your system, on the iDRAC web interface, click ? > About.</p>	iDRAC Manuals
	<p>For information about installing the operating system, see the operating system documentation.</p>	Operating System Manuals

Table 122. Additional documentation resources for your system (continued)

Task	Document	Location
	For information about updating drivers and firmware, see the Methods to download firmware and drivers section in this document.	Drivers
Managing your system	For information about installing and using Dell Secure Connect Gateway, see the Dell Secure Connect Gateway Enterprise User's Guide.	serviceability tools
Working with the Dell PowerEdge RAID controllers (if applicable)	For information about understanding the features of the Dell PowerEdge RAID controllers (PERC), Software RAID controllers, or BOSS card and deploying the cards, see the Storage controller documentation.	Storage Controller Manuals
Understanding event and error messages	For information about the event and error messages generated by the system firmware and agents that monitor system components, see the EEMI guide.	EEMI guide
Troubleshooting your system	For information about identifying and troubleshooting the PowerEdge server issues, see the Server Troubleshooting Guide.	PowerEdge manuals